

## VersaChart Manual Revision Log

Revision		Date	Description
Edition 1		6/16/95	Released
Edition 1	RevA	7/14/95	Revised Pages: 4, 5, 1-1 thru 1-5, 2-8, 4-3, 4-5, 4-6, 4-9 thru 4-11, 4-17, 4-37, 4-39, 4-40, 4-42, 4-48, 4-50, 4-57, 4-100, 4-101, 7-1 thru 7-3, 10-1, 11-1, C-2, C-3, C-5 thru C-7, C-10, C-11, C-13; added D-1 thru D-4 and E-1 thru E-2.
Edition 1	Rev B	8/10/95	Revised Pages: 2-9 thru 2-13, 3-16, 4-13, 4-29, 11-2 thru 11-7, B-1 thru B-2, C-4, C-10 and E1 thru E3.
Edition 1	Rev C	11/6/95	<u>Revised Pages:</u> 5, 1-3, 1-5, 2-6, 2-15, 3-5, 3-6, 3-35, 4-8, 4-17, 4-26, 4-45, 4-79 thru 4-101, 6-9 thru 6-14, 8-1, 10-1 thru 10-2, 11-4, 11-6, A-1, A-4, E1 thru E3; <u>Added Pages:</u> 10-3 thru 10-5, 11-7 thru 11-8, A-6 thru A-7, D-7; <u>Deleted Pages:</u> 4-102.
Edition 1	Rev D	4/15/96	<u>Revised Pages:</u> 1, 3, 5, 1-3 thru 1-6, 2-1, 2-3, 2-4, 2-6, 2-8, 2-15, 2-16, 3-3 thru 3-8, 3-10, 3-11, 3-19 thru 3-21, 3-24, 3-28, 3-29, 3-36 thru 3-39, 4-1 thru 4-3, 4-6 thru 4-13, 4-15, 4-17, 4-18, 4-23, 4-24, 4-26, 4-30, 4-31, 3-35, 4-58, 4-59, 4-62, 4-63, 4-65 thru 4-67, 4-71, 4-73, 4-74, 4-77 thru 4-99, 5-2, 6-1, 6-6, 6-12, 6-13, 8-4, 9-3 thru 9-8, 10-4, 11-5 thru 11-8, A-2, B-2, E-2. <u>Added Pages:</u> 8-5, 9-7, 9-8, A-8. <u>Deleted Pages:</u> 4-100, 4-101.
Edition 1	Rev E	9/18/96	<u>Revised Pages:</u> 1, 2-2, 4-23 thru 4-24, 4-58 thru 4-59, 4-63, 4-65, 4-67, 4-73 thru 4-74, 4-80, 4-87, 4-91, 4-95 thru 4-96, 11-1 thru 11-4, C5, C14, D-3
Edition 2	Rev F	4/1/97	<u>Revised Pages:</u> 1-1, 1-3, 1-4, 1-5, 2-16, 3-13, 3-16, 3-17, 3-23, 3-29, 3-33, 3-44, 4-2, 4-17, 4-20, 4-21, 4-22, 4-23, 4-24, 4-34, 4-36, 4-38, 4-39, 4-41, 4-42, 4-45, 4-54, 4-58, 4-59, 4-63, 4-65, 4-66, 4-67, 4-68, 4-69, 4-73, 4-74, 4-75, 4-77, 4-78, 4-80, 4-87, 4-91, 4-93, 4-94, 5-1, 6-6, 6-12, 6-13, 8-2, 8-3, 8-4, 8-5, 9-2, 9-6, <u>Added Pages:</u> 3-24, 3-25, 3-36, 3-37, 3-43, SEC 13

<b>Revision</b>		<b>Date</b>	<b>Description</b>
Edition 3	Rev G	7/1/98	Revised Pages: 9-2 thru 9-22
			<u>Added Pages:</u> SEC 14

---

# VersaChart Manual Prefix

## MANUAL ORGANIZATION

This manual is organized in twelve major sections:

Section 1	Introduction and General Information
Section 2	Installation and Wiring
Section 3	The Basics of Recorder Operation
Section 4	Configuration
Section 5	Display Programming
Section 6	Chart Prompts
Section 7	Alarm Settings
Section 8	Action Time Settings
Section 9	Enables & Passwords
Section 10	Test
Section 11	Calibration
Section 12	Appendix
Section 13	Controllers
Section 14	Profilers

*All users should be familiar with the first three sections of this manual before beginning to operate the recorder.*

Operators are then advised to cover the Display Programming, Chart Prompts and Alarm Setting sections. Configurators should be familiar with all information, particularly the details in the Configuration Programming section.

## PARTLOW TECHNICAL AND APPLICATION SUPPORT

Please have your recorder model number AND serial number available before calling for technical and application support. Support is available from:

**The Partlow Corporation  
2 Campion Road  
New Hartford, NY 13413**

**1-800-866-6659 or 1-315-797-2222  
Fax: 1-315-797-0403 or 1-315-793-1864**

---

# Table of Contents

	<b>PAGE</b>
<b>SECTION 1 - INTRODUCTION AND GENERAL INFORMATION</b>	<b>1-1</b>
1.1 Unpacking	1-1
1.2 Installation of Pen Cartridge Assembly	1-2
1.3 Order Matrix/Model Number	1-3
1.4 Specifications	1-4
1.5 Warranty Statement	1-7
<b>SECTION 2 - INSTALLTION AND WIRING</b>	<b>2-1</b>
2.1 Mounting	2-1
2.2 Preparation for Wiring	2-3
2.3 Wiring Connections - Inputs	2-6
2.3.1 Shipped Configuration/Jumper Positioning	2-7
2.3.2 Sensor Break	2-7
2.3.3 AC Power Connections	2-8
2.3.4 Thermocouple Connections	2-9
2.3.5 RTD Connections	2-10
2.3.6 Voltage Connections	2-11
2.3.7 Current Connections	2-12
2.3.8 Switch Input Connections	2-13
2.4 Wiring Connections - Outputs	2-14
2.4.1 SPDT Relay	2-14
2.4.2 Solid State Relay Driver (SSRD)	2-14
2.4.3 Current Output	2-15
2.4.4 24 VDC Transmitter Power Supply	2-15
2.4.5 Communications	2-16
<b>SECTION 3 - THE BASICS OF RECORDER OPERATION</b>	<b>3-1</b>
3.1 Power-Up	3-1
3.2 Instrument Modes	3-1
3.2.1 Normal Display	3-1
3.2.2 Display Prompts	3-1
3.2.3 Chart Prompts	3-1
3.2.4 System Prompts	3-1
3.3 Keypad Functions	3-2
3.3.1 DISPLAY key	3-2
3.3.2 CHART key	3-2
3.3.3 SCROLL key	3-2
3.3.4 ARROW keys	3-2
3.3.5 RESET key	3-2
3.3.6 ESCAPE key, MODIFY key, ENTER key	3-2
3.3.7 Special keys	3-2
3.4 Changing Parameter Settings - Modify	3-3
3.4.1 Changing Values	3-3
3.4.2 Changing Text	3-3
3.4.3 Changing Choices	3-3
3.4.4 Copy/Initialize	3-4
3.4.5 Passwords	3-4
3.4.6 Enables	3-4
3.5 The Display	3-4
3.6 General	3-4
3.7 Display Details	3-5
3.8 Chart Details	3-7

	<b>PAGE</b>
3.8.1 Chart Printing Interruptions	3-8
3.8.2 New Chart Printing Requirements	3-9
3.8.3 Example Chart	3-9
3.8.4 Sequence of Events	3-12
3.9 Getting Started	3-13
3.10 Quick Start Procedure	3-14
<b>SECTION 4 - CONFIGURATION</b>	<b>4-1</b>
4.1 Entering Configuration	4-1
4.1.1 Inputs	4-1
4.1.2 Constants	4-14
4.1.3 Custom Curves	4-15
4.1.4 Derived Variables	4-18
4.1.5 Process Variables	4-32
4.1.6 Recorders	4-43
4.1.7 Totalizers	4-52
4.1.8 Timers	4-61
4.1.9 LEDs	4-64
4.1.10 Relays	4-66
4.1.11 Current Outputs	4-69
4.1.12 Instrument Settings	4-72
4.1.13 Derived Actuators	4-78
4.1.14 Operator Inputs	4-81
4.1.15 Operator Messages	4-85
4.1.16 Chart Messages	4-89
4.1.17 Simulated Variables	4-95
<b>SECTION 5 - DISPLAY PROGRAMMING</b>	<b>5-1</b>
<b>SECTION 6 - CHART PROMPTS</b>	<b>6-1</b>
6.1 Change Chart	6-1
6.2 Chart Configuration	6-2
<b>SECTION 7 - ALARM SETTINGS</b>	<b>7-1</b>
<b>SECTION 8 - ACTION TIME SETTINGS</b>	<b>8-1</b>
<b>SECTION 9 - ENABLES &amp; PASSWORDS</b>	<b>9-1</b>
<b>SECTION 10 - TEST</b>	<b>10-1</b>
<b>SECTION 11 - CALIBRATION</b>	<b>11-1</b>
<b>SECTION 12 - APPENDIX</b>	
A - Board Layouts	A-1
B - Ranges	B-1
C - Reference Section	C-1
D - Examples	D-1
E - Accuracy Tables	E-1

	<b>PAGE</b>
<b>SECTION 13 -CONTROLLERS</b>	<b>13-1</b>
13.1 Entering Controllers	13-3
13.2 Control Setpoints	13-18
13.3 Control State Access	13-22
13.4 Tuning Parameters	13-31
<b>SECTION 14 -PROFILERS</b>	<b>14-1</b>
14.1 Profile Entry	14-1
14.2 Profile Settings	14-4
14.3 Profile Control	14-7

---

## Figures and Tables

Figure 1-1	Pen Cartridge Installation	1-2
Figure 2-1A	Mounting Dimensions	2-1
Figure 2-1B	Dimensional Drawing	2-2
Figure 2-2	Noise Suppression	2-4
Figure 2-3	Noise Suppression	2-4
Figure 2-4	Board and Terminal Locations	2-6
Figure 2-5	Shipped Jumper Positions	2-7
Figure 2-6A	AC Power Connections, 115/230	2-8
Figure 2-6B	AC Power Connection, Universal	2-8
Figure 2-7	TC Connections	2-9
Figure 2-8	RTD Connections	2-10
Figure 2-9	Voltage Connections	2-11
Figure 2-10	Current Connections	2-12
Figure 2-11	Switch Input Connections	2-13
Figure 2-12	SPDT Relay Output	2-14
Figure 2-13	SSR Driver Output	2-14
Figure 2-14	Current Output	2-15
Figure 2-15	Transmitter Power Supply	2-15
Figure 2-16	RS-485 Communications	2-16
Figure 2-17	RS-232 Communications	2-16
Figure 3-1	Keypad	3-2
Figure 3-2	Example of Chart	3-12
Figure 11-1	Jumper Positions for Calibration	11-3
Figure A-1	Power Supply Board	A-1
Figure A-2	Mother Board	A-2
Figure A-3	Relay/SSR Board	A-3
Figure A-4	Input Board	A-4
Figure A-5	Motor Driver Board	A-5
Figure A-6	Current Output Board	A-6
Figure A-7	Transmitter Power Supply	A-7
Figure A-8	Communication Board	A-8
Table 2-1	Board ID Jumpers	2-7
Table 3-1	Configure Chart Parameters	3-10
Table 3-2	Recorder Parameters	3-11
Table 10-1	Available Tests	10-1
Table 11-1	Calibration Routines	11-1
Table 11-2	Range Select	11-2
Table 11-3	Input Board Jumper Positions	11-3

---

## Section 1 - Introduction and General Information

This instrument is a microprocessor based circular chart recorder capable of measuring, displaying, and recording from a variety of inputs. Applications include temperature, level, pressure, flow, and others. The instrument can be specified as either a one, two, three, or four pen model.

The standard process sensor inputs (up to 8 total inputs) are user configurable to directly connect to and convert thermocouple, RTD, millivolt, volt, milliamp or contact closure inputs. Thermocouple and RTD linearization, as well as thermocouple cold junction compensation, are performed automatically. Up to four individually isolated 24 VDC regulated transmitter power supplies are available for transmitter inputs, each providing up to 25 mADC.

Using the optional math capability, mass flow, BTUs, relative humidity, and other derived variables can be calculated, as well as simple math functions performed and custom curve conversions. Optional totalization is available for input values or derived variables. Any recorder value can be treated as a process value, to provide alarming and special display capability.

Up to 4 variables can be recorded as analog trend lines on chart sizes of 10, 11, or 12 inches in diameter. The trend lines can be the result of instantaneous values, connecting the values, drag pen, average values, or connecting the average values. The trend lines can be scaled and positioned on the chart in zones. Trend scales, units, and a trend tag can be printed in the same color as time lines.

Dates, times, batch numbers, operator IDs, process values, scales and alarm messages can all be printed on the chart in color.

Definitions for a large number of "Terms and Concepts" described in this manual are included in Appendix C.

---

### 1.1 UNPACKING

Remove the instrument and pen cartridge assembly from the shipping container and inspect for any damage due to shipment. If any damage is noticed due to transit, report and file a claim with the carrier. Write the model number and serial number in spaces provided on Page 1-3 of this manual for future reference. The model number and serial number are found on the label on the case, viewed when platen is open.



CAUTION: READ THIS MANUAL

THE INTERNATIONAL HAZARD SYMBOL IS FOUND ADJACENT TO THE LOWER PLATEN HOLD DOWN SCREW. IT IS IMPORTANT TO READ THIS MANUAL BEFORE INSTALLING OR COMMISSIONING THE UNIT.

## 1.2 INSTALLATION OF PEN CARTRIDGE ASSEMBLY

Remove the pen cartridge assembly from its shipping container. With mounting tab on the bottom, slide the pen cartridge assembly (item 2 on Figure 1-1) into the print actuator (item 1 on Figure 1-1).

**FIGURE 1-1**

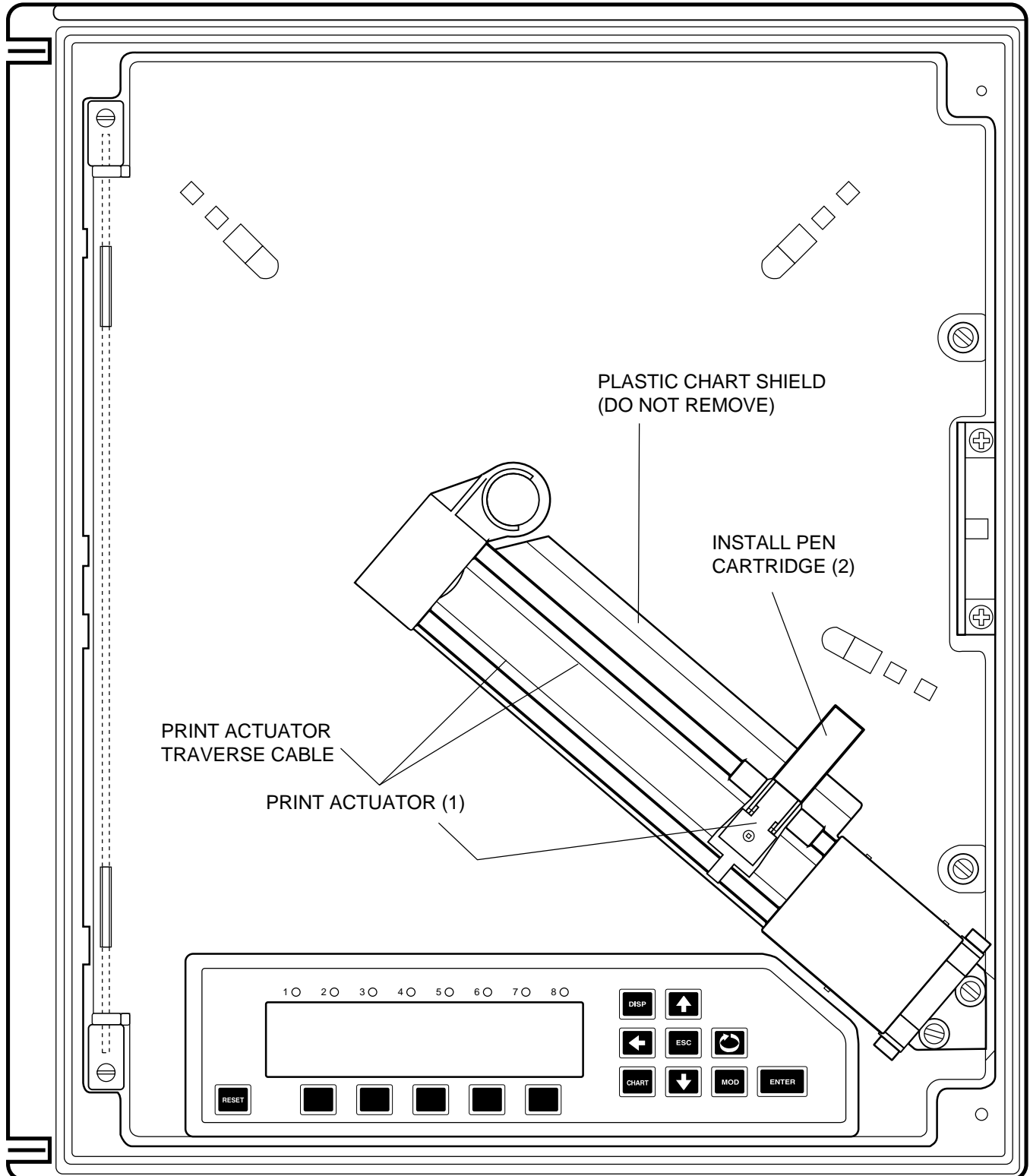



### 1.3 ORDER MATRIX/MODEL NUMBER

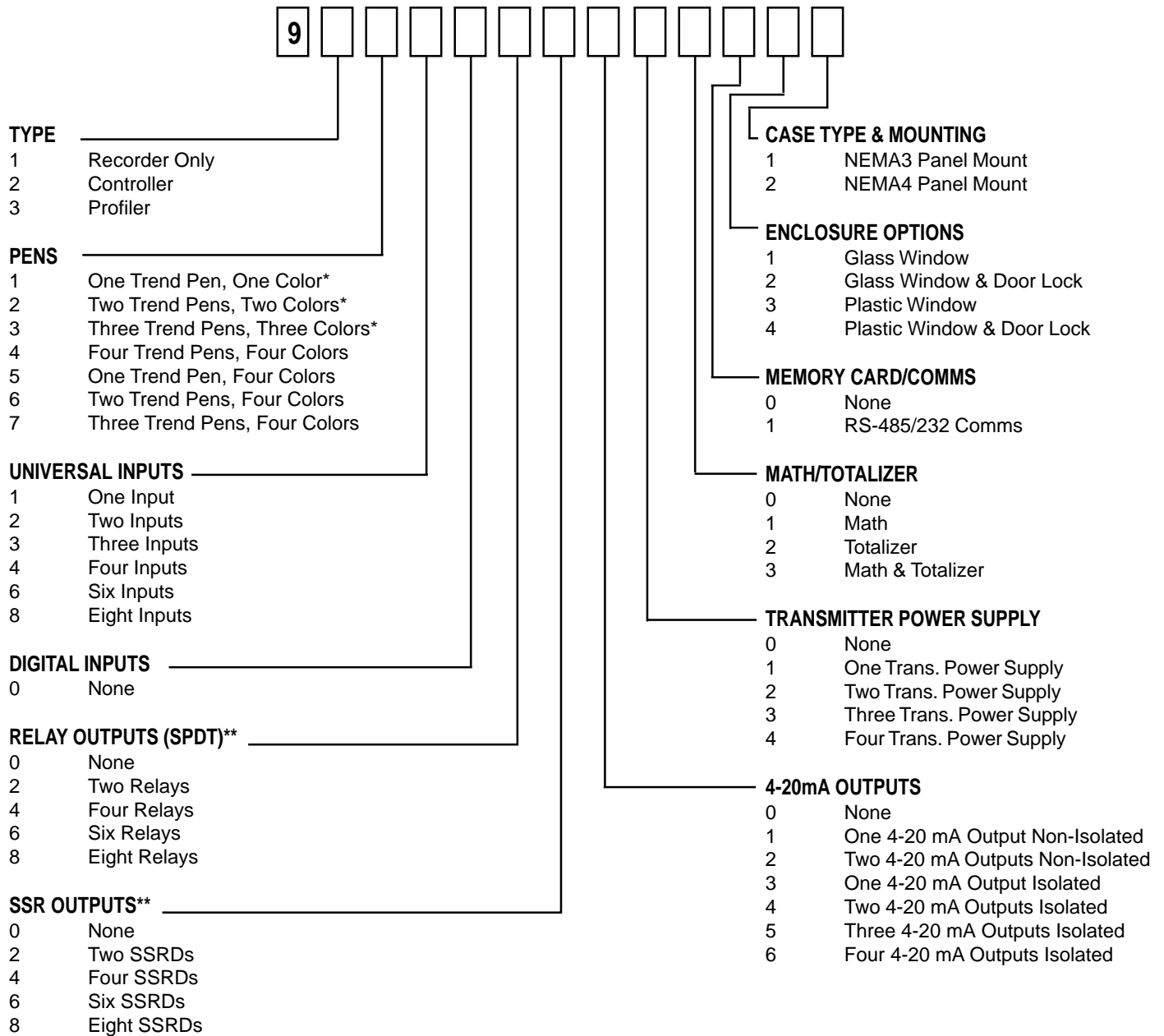

\* Pens/colors are added to the instrument in the following order: red, then green, then blue, and then black.

\*\* Total quantity of SPDT Relays and SSR Drivers must be less than or equal to eight.

**Model Number** \_\_\_\_\_

**Serial Number** \_\_\_\_\_

---

## 1.4 SPECIFICATIONS

---

### **DESCRIPTION**

The instrument is the first circular chart recorder with the ability to record trend data and print alphanumeric annotation in four colors. It uses unique "rings only" charts and has the ability to zone and scale trend data. These capabilities not only provide the best trend data readability, but also instant association with the corresponding scales. Whether it's a basic application of recording inputs, to a demanding application requiring derived variables, logic functions, totalization, or other capabilities, the instrument can be supplied with the necessary level of sophistication, while maintaining an uncomplicated operator interface.

---

### **MODELS**

The instrument is available in versions for trend recording of one to four values. The number of colors can equal the number of trended values, or all four colors can be provided. The latter option provides the greatest color flexibility and makes it easier to add trend capability to the instrument in the field. The instrument can have up to eight inputs, and inputs are not directly associated with trend pens. The instrument can trend any combination of inputs, averages, derived variables, logic states, even totals. A full compliment of options provides the flexibility to handle virtually any type of application.

---

### **FEATURES**

- Color chart annotation
- 1, 2, 3 and 4 trend pen versions
- All versions with optional four color capability
- 10", 11", or 12" charts
- Linear scales and radial time lines
- Trend zoning and dual zone capability
- Up to 8 universal inputs
- 40 character, vacuum fluorescent display
- Simultaneous display of up to 4 process values
- Building block approach for flexibility
- Math and equation package with custom curves
- Logic equations for actuators
- 9 digit totalizes
- Chart messages
- Operator inputs
- Operator messages
- Real time clock
- Time and date printed on charts

---

### **CONFIGURATION**

A multilevel prompting scheme provides rapid access to all configuration data. By model number and selective enabling, the software displays only those configuration sections needed. The 40 character, vacuum fluorescent display provides true English language prompts. The 15 key keypad makes moving through the prompts and modifying the parameters intuitive. Multiple choice selections and use of "quick select keys" simplifies the programming of many parameters. Copy functions make configuring similar sets of parameters even faster. Two methods of modifying character strings simplifies the entry of English tags and units. The instrument even displays the proper jumper placement for the installer. The instrument can virtually be configured without looking at the manual.

---

## **OPERATOR INTERFACE**

Beyond the configuration capability, the display, keypad, and prompting system provide superior real time data presentation. The display of each instrument value is configurable and three display formats are available, providing a range from fully detailed displays with 20 character tags, alarm indications, values, and units, to four process values displayed simultaneously. Separate keys are used to access the display, chart, and configuration related areas. By selective enabling and password protection, access to various operational areas of the instrument can be limited or controlled. Some keys can also be configured to provide special functions, such as resetting totalizers. The operator interface has been designed to make daily operation as simple as possible. Changing charts, for example, requires only three keystrokes.

---

## **CONSTRUCTION**

The instrument is housed in a structural foam moulded enclosure which can be panel or surface mounted. Mounting brackets are included. Its design allows it to fit into the smallest panel cutout of competitive products, while it covers the largest cutout of others. Glass and plastic windows are available, along with a cover lock. The standard enclosure carries a NEMA3 rating, with an optional NEMA4X available.

---

## **OPTIONS**

The instrument is available with a full compliment of options. Up to eight isolated universal inputs are available with each being configurable to any of the available input types. Up to four isolated transmitter power supplies can be added. Up to four inputs or derived variables can be assigned as "process variables", allowing up to four alarms for each. Alarms can be process high or low, or rate rising or falling. The alarming capability is standard, but the hardware outputs are optional. Up to eight on/off outputs are available, either relay or solid state relay driver outputs. Besides alarms, any of over eighty other digital values/ states can be used to actuate on/off outputs. Up to two non-isolated analog outputs or up to 4 isolated analog outputs are available. Any of over twenty values can be used to drive analog outputs (i.e. inputs, derived variables, etc.) Other options include PC based configuration software and a communications interface.

---

## **FIELD UPGRADES**

All of items listed in the Options section are easily installed in the field. Typically it involves just adding boards, but possibly PROMs may need to be changed as well. To add totalizers or the math package, only PROMS must be changed. If the four color option was purchased, only PROMS need to be changed to expand trend capability, otherwise, a relative costly pen arm assembly must be replaced as well.

---

## **INPUTS**

Input Types	Types J, K, T, R, S, E, B, N, G, D, C, Ni/Ni-Moly, and Platinel II.
Thermocouple	Platinum 100, 2 or 3 wire
RTD	.00385 coefficient DIN 43760/IEC 751 .00392 coefficient USA .00392 coefficient SAMA Nickel 100, 2 or 3 wire
Voltage DC	0 to 25mV, 0 to 100 mVDC, 0 to 1 VDC, 0 to 10 VDC
Current DC	0 to 20mA, 4 to 20mA Internal 50 ohm shunt resistor
Contact Closure	Open/closed switch sensing without external voltages or resistors
Impedance	25mV, 100mV, 1 Volt: > 10 meg ohms 10 Volt: > 50 K ohms mA: 50 ohms
RTD Excitation Current	1 mA

---

## **INPUT PERFORMANCE**

Measurement Error	± .025% of measurement span reference accuracy
Cold Junction Compensation Error	± 0.2°C @ 25 degrees C
Cold Junction Compensation Rejection	0.04°/degree C deviation from 25 degrees C
Linearization Error	TCs: ± 0 .25°C typical, ± 0.5°C worst case with exceptions RTDs: ± 0.1°C typical, ± 0.3°C worst case
Ambient Temperature Error	± 0 .01% of span per degree C deviation from 25 degrees C
Factory Calibration Error	Refer to the Accuracy Table
Isolation	500 VDC/350 VAC
Common Mode Rejection	120 dB min.
Normal Mode Rejection	100 dB min. @ 60 Hz or greater
Scan Rate	The input scan rate is programmable and dependant on the number of active inputs present. The total scans per second for the instrument is 16 scans/second, and the instrument can have up to 8 inputs configured.

## ACCURACY TABLES

TC TYPE	See Note:	1	2	3	4	5	6
	RANGE °C	REF ACC'Y °C	LIN. ACC'Y °C	FACTORY CAL °C	REF+LIN +CAL °C	DEVIATION ACC'Y °C	RESOL °C/bit
J WIDE	0/1200	0.43	0.20	0.32	0.95	0.12	0.066
	-200/0	0.63	0.08	0.56	1.28	0.02	0.097
J NARROW	0/400	0.11	0.05	0.33	0.50	0.04	0.017
	-200/0	0.16	0.08	0.56	0.80	0.02	0.024
K WIDE	0/1370	0.62	0.26	0.40	1.28	0.14	0.095
	-250/0	1.05	0.30	0.78	2.13	0.03	0.159
K NARROW	0/500	0.15	0.08	0.39	0.62	0.05	0.023
	-250/0	0.26	0.30	0.78	1.35	0.03	0.040
E WIDE	0/1000	0.33	0.19	0.28	0.80	0.10	0.050
	-250/0	0.66	0.42	0.62	1.71	0.03	0.101
E NARROW	0/300	0.09	0.19	0.29	0.57	0.03	0.014
	-250/0	0.17	0.42	0.62	1.21	0.03	0.025
N WIDE	0/1300	0.68	0.21	0.42	1.32	0.13	0.104
	-250/0	1.44	0.60	0.93	2.97	0.03	0.220
N NARROW	0/600	0.18	0.11	0.44	0.73	0.06	0.028
	-200/0	0.31	0.20	0.81	1.32	0.02	0.048
	-250/-200	0.93	0.60	2.15	3.68	0.01	0.142
<b>To achieve stated results, the following thermocouples must be used with the INPUTTYPE/RANGE set to TC NARROW</b>							
G	1800/2300	1.59	0.54	0.79	2.92	0.05	0.243
	800/1800	1.23	0.43	0.64	2.30	0.10	0.188
	500/800	1.38	0.25	0.70	2.33	0.03	0.210
	300/500	1.79	0.25	0.87	2.91	0.02	0.274
	0/300	3.65	0.58	1.61	5.84	0.03	0.557
C	1800/2300	2.14	0.54	1.01	3.68	0.05	0.326
	1200/1800	1.62	0.43	0.80	2.85	0.06	0.247
	300/1200	1.33	0.28	0.68	2.29	0.09	0.202
	0/300	1.54	0.12	0.77	2.43	0.03	0.235
D	1800/2300	1.88	0.38	0.90	3.26	0.05	0.287
	300/1800	1.32	0.40	0.68	2.40	0.15	0.201
	0/300	1.75	0.26	0.85	2.86	0.03	0.267
NNM	450/1370	0.44	0.33	0.33	1.10	0.09	0.067
	0/450	0.56	0.13	0.37	1.06	0.05	0.085
Platine II	1000/1400	0.72	0.28	0.44	1.44	0.04	0.110
	500/1000	0.59	0.20	0.38	1.17	0.05	0.089
	0/500	0.62	0.10	0.40	1.12	0.05	0.095

**ACCURACY TABLES CONT.**

To achieve stated results, the following thermocouples must be used with the INPUT TYPE/RANGE set to TC NARROW

TC TYPE	See Note:	1	2	3	4	5	6
	RANGE °C	REF ACC'Y °C	LIN. ACC'Y °C	FACTORY CAL °C	REF+LIN +CAL °C	DEVIATION ACC'Y °C	RESOL °C/bit
T	0/400	0.12	0.09	0.34	0.55	0.04	0.018
	-200/0	0.23	0.19	0.70	1.12	0.02	0.036
	-250/-220	0.73	0.36	1.90	2.98	0.00	0.111
R	800/1700	0.43	0.19	0.83	1.45	0.09	0.065
	200/800	0.58	0.25	1.08	1.90	0.06	0.088
S	250/1750	0.56	0.25	1.05	1.87	0.15	0.086
B	200/1800	0.74	0.31	1.34	2.39	0.16	0.113

RTD TYPE	See Note:	1	2	3	4	5	6
	RANGE °C	REF ACC'Y °C	LIN. ACC'Y °C	FACTORY CAL °C	REF+LIN +CAL °C	DEVIATION ACC'Y °C	RESOL °C/bit
385 DIN	-160/480	0.16	0.03	0.13	0.33	0.06	0.025
	-200/-160	0.14	0.20	0.12	0.46	0.00	0.022
392 USA	-100/450	0.16	0.03	0.13	0.32	0.05	0.025
392 SAMA	-200/560	0.29	0.13	0.24	0.66	0.06	0.044
100 ohm Nickel	-40/200	0.09	0.05	0.07	0.21	0.02	0.013

**ACCURACY TABLES CONT.**

INPUT TYPE	See Note:	1	3	4	5	6
	SPAN mV	REF. ACC'Y uV	FACTORY CAL uV	REF+LIN +CAL uV	DEVIATION ACC'Y uV	RESOL °C/bit
10V	0/10000	2500	1000	3500	1000	381
1V	0/1000	250	100	350	100.0	38.1
100mV	0/100	25	20	45	10.0	3.81
25mV	0/25	6	20	26	2.5	0.954

INPUT TYPE	See Note:	1	3	4	5	6
	SPAN mA	REF. ACC'Y uA	FACTORY CAL uA	REF+CAL uA	DEVIATION ACC'Y uA/°C	RESOL. uA/bit
mA	4/20	5	2	7	2.0	0.763
	0/20	5	2	7	2.0	0.763

NOTES: The table attempts to show the effect of each significant factor which contributes to the overall measurement error. See the enumerated items below for more specific explanations of each column of data.

1. Reference Acc'y based on 0.025% (250ppm) of input voltage span.
2. Linearization Acc'y is based on conformance to NIST Monograph 175 (based on the ITS-90) for letter-designated thermocouple types, or other industry standards for non letter-designated type TCs and all RTDs.
3. Factory Cal is defined by limits of repeatability in a manufacturing environment per the table for zero and span calibrations, and  $\pm 0.15^\circ\text{C}$  for thermocouple cold junction calibrations.
4. The REF + LIN + CAL column represents the total "static" error allowed for an instrument as produced by the manufacturing process.
5. Deviation Acc'y is derived from a temperature coefficient of  $0.01\%/^\circ\text{C}$  or  $\pm 100\text{ppm}/^\circ\text{C}$  expressed in units of the corresponding range.
6. Resolution on thermocouples and RTDs is derived as a function of the input voltage range and  $dV/dT$ .

---

## **OTHER INPUT SPECIFICATIONS**

Processing	Square root and exponential functions for linear inputs
Value Cutoff	None, at value, to zero below value, to zero near zero
Sensor Fault Detection	Sensor break on all TCs, RTDs, 1 volt, 1 to 5 volt, 4-20mA, and millivolt inputs
	Sensor high and low on all inputs, 5% above or below range
Sensor Break	Upscale or downscale
Transmitter Power Supplies	Up to four isolated 25mA @ 24VDC supplies available

---

## **RECORDING**

Pen Type	Disposable 4 pen fiber tip marker assembly
Pen Colors	Red, green, blue, and black
Chart Size	10", 11", 12" (12" are 11.875" actual size)
Chart Drive	DC stepper motor
Chart Rotation	6 to 9999 hours per revolution
Recorded Values	Any of over 20 values can be trended/recorded
Recording Methods	Drag pen simulation, instantaneous value, connect the values, average value, connect the averages
Action on New Chart	Print scales, print range list, begin normal recording
Chart Messages	Twelve

---

## **RECORDING PERFORMANCE**

Chart Recording Accuracy	0.3% of chart span reference accuracy
Chart Rotation Accuracy	± 0.2 minutes for a 24 hour rotation, assuming all backlash removed

---

## **OPERATOR INTERFACE**

Display	Two line, 40 character vacuum fluorescent display with .21 inch (5 mm) high characters
Status Indicators	Eight user configurable, red LED status indicators
Keypad	Fifteen keys for programming and unit operation
Display Formats	Three, refer to manual
Display Modes	Automatic or manual sequencing
Operator Messages	Twelve
Operator Inputs	Twelve

---

## **ALARMS**

Number	Up to four alarms for each of four process variables
Type	Process high or low, rate rising or falling
Hysteresis	Fully adjustable

---

## **ON/OFF OUTPUTS**

On/Off Output Actuators	Any of over 100 digital values/states can be used to actuate on/off outputs (e.g. alarms, time/dates, timers, etc.)
Relays	SPDT, contacts rated 5 amps resistive at 115 VAC, 2.5 amps resistive at 230 VAC - 1/8 HP at 230 VAC (single phase), 250 VA at 115/230 VAC.
Solid State Relay Driver	Open collector output, can provide 40mA at 3 VDC or 20mA at 4VDC
	Short circuit current is limited to 100 mA
Pulsed Outputs	50ms pulse when used with totalizer pulsed outputs



---

## **CURRENT OUTPUTS**

Drivers	Any of over 20 values can be used to drive analog outputs (e.g. inputs, derived variables, etc.)
Output Span	0 to 20mA or 4 to 20mA, nominal
Resolution	12 bits based on a 0 to 25.6mA span
Accuracy	± 0.1% of 20mA span reference accuracy
Compliance	650 ohm load

---

## **TOTALIZERS**

Number	Four are included in the option
Digits	Nine, displayable with and without commas
Types	Continuous, preload count down, and pulse counting
Presets	One per totalizer
Pulsed Outputs	Fully configurable

---

## **COMPUTING CAPABILITIES**

Derived Variables	Twelve
Math functions	Add, subtract, multiply, divide, average, exponential, log 10, log e, power 10, power e
Built-In Equations	Linear, polynomial, C to F, F to C, linear mass flow, DP mass flow, BTU, RH, Fo, ZrO <sub>2</sub> .
Other Functions	High select, low select, high peak, low peak, track and hold, 1 of 2 selector, convert actuator
Custom Curves	Four 21 point curves, usable in multiple calculations
RH Calculation	Typically accurate to better than 1% Clamps calculated value @ -10% and +110%

---

## **LOGIC CAPABILITIES**

Actuators	Over 100 digital values are accessible
Derived Actuators	Twenty four combinations of 24 items
Logic Operators	NOT, OR, AND, parentheses
Timers	Four
Time/Date Combination Actuators	Six

---

## **POWER REQUIREMENTS**

Line Voltage	Universal power supply, 85 min to 265 max. VAC 50/60Hz
Power Consumption	60 VA maximum

---

## **CONSTRUCTION**

Enclosure	Gasketed cover, case, and windows. Structural foam case and cover with plastic or glass window areas. Door lock available.
NEMA Rating	NEMA 3 standard, NEMA 4X optional
Conduit Openings	Four openings standard, 2 additional as required
Mounting	Panel, wall, or optional pipe mounting
Overall Dimensions	14.12 inches wide x 16.77 inches high x 7.75 inches deep (358.65mm wide x 425.96mm high x 196.85mm deep)

(CONTINUED ON NEXT PAGE)

---

## **CONSTRUCTION (cont.)**

Panel Cutout	12.7 inches wide x 12.7 inches high (322.58mm wide x 322.58mm high)
Panel Depth	5.25 inches (133.35 mm)
Panel Protrusion	2.5 inches (63.5mm)
Weight	25 lbs maximum

---

## **ENVIRONMENTAL AND OPERATING CONDITIONS**

Operating Temperature	0 to 50°C (32 to 122°F)
Storage Temperature	-40 to 65°C (-40 to 149°F)
Humidity	10 to 90% RH, non-condensing
Vibration	0.3 to 100 Hz @ 0.2g
Mounting Position	Up to 30° forward or backward tilt from vertical Up to 10° side tilt from vertical
Reference Conditions	25°C ± 2°C and 60% RH ± 5% RH

---

## **OTHER SPECIFICATIONS**

Clock Accuracy	1 minute/month typically, 4 minutes/month worst case
Battery Backup	5 years minimum life, 10 years typically
Simulated Variables	Four function generators

---

## **DIGITAL COMMUNICATIONS**

Type	RS-232C/RS-485 serial communications port. Half-duplex.
Protocol	ModBus RTU
Network Control	Can be configured as either the master or a slave
Bit Rate	User configurable 1200, 2400, 4800, or 9600 bit per second
Parity	Odd, even or none
Address	User configurable 1 to 247

---

## **GENERAL REFERENCE DATA**

Data Backup	EEPROM for input board calibration data EEPROM for motherboard calibration data Battery backed SRAM for configuration data
Warranty	Two years

---

## **APPROVALS AND COMPLIANCE**

Safety	UL Approved for USA - UL 1092, UL 916, and QUXY - File E67237 UL Certified for Canada - CSA Spec 142 - File E67237
Immunity/Susceptibility	CE - Complies with EN 50082-1
Emissions	CE - Complies with EN 55011
Hazardous Locations	ETL Listed Class I and II, Division 2 and Class III, Division 1 and 2, Reference No. 5604?2

\* ModBus is a trademark of MODICON, Inc.

---

## 1.5 WARRANTY AND RETURN STATEMENT

These products are sold by the factory under the warranties set forth in the following paragraphs. Such warranties are extended only with respect to a purchase of these products, as new merchandise, directly from the factory or from a factory distributor, representative or reseller, and are extended only to the first buyer thereof who purchases them other than for the purpose of resale.

### ***Warranty***

These products are warranted to be free from functional defects in materials and workmanship at the time the products leave the factory and to conform at that time to the specifications set forth in the relevant factory instruction manual or manuals, sheet or sheets, for such products for a period of two years.

**THERE ARE NO EXPRESSED OR IMPLIED WARRANTIES WHICH EXTEND BEYOND THE WARRANTIES HEREIN AND ABOVE SET FORTH. PARTLOW MAKES NO WARRANTY OF MERCHANTABILITY OR FITNESS FOR A PARTICULAR PURPOSE WITH RESPECT TO THE PRODUCTS.**

### ***Limitations***

The factory shall not be liable for any incidental damages, consequential damages, special damages, or any other damages, costs or expenses excepting only the cost or expense of repair or replacement as described above.

Products must be installed and maintained in accordance with the factory instructions. Users are responsible for the suitability of the products to their application. There is no warranty against damage resulting from corrosion, misapplication, improper specifications or other operating condition beyond our control. Claims against carriers for damage in transit must be filed by the buyer.

This warranty is void if the purchaser uses non-factory approved replacement parts and supplies or if the purchaser attempts to repair the product themselves or through a third party without factory authorization.

### ***Returns***

The factory's sole and exclusive obligation and buyer's sole and exclusive remedy under the above warranty is limited to repairing or replacing (at the factory's option), free of charge, the products which are reported in writing to the factory at its main office.

The factory is to be advised of return requests during normal business hours and such returns are to include a statement of the observed deficiency. The buyer shall pre-pay shipping charges for products returned and the factory or its representative shall pay for the return of the products to the buyer.

## Section 2 - Installation and Wiring

Read these instructions carefully before proceeding with installation and operation. Electrical code requirements and safety standards should be observed. Installation should be performed by qualified personnel.

### 2.1 MOUNTING (Panel and Surface described below, pipe - to be determined)

Figure 2-1A and 2-1B (below and page 2) shows an installation view and physical dimensions for a panel mounted instrument. The panel where the instrument will be mounted must provide rigid support for the approximately 25 pound instrument. Adjacent instruments may be mounted within a minimum of 2 inches horizontally and 1 inch vertically, providing that proper panel support is supplied.

Panel Mounting Hardware Required: (not provided with instrument)

(4) #10 flat head bolts with nuts

(4) lock washers

#### Panel Mounting

1. Cut panel opening to the dimensions illustrated in Figure 2-1A (below).
2. Pre-drill four 3/16 dia. holes for mounting or use the drill template molded into the case after inserting the instrument into the panel.
3. Insert the instrument in the panel opening. Firmly fasten the instrument to the panel using the nuts, bolts and lock washers.

#### Surface Mounting

Install the mounting brackets, ordered separately, on the vertical sides of instrument housing. Use the brackets to fasten the instrument to the surface. Hardware recommended - #10-24 SCRs.

**FIGURE 2-1A**

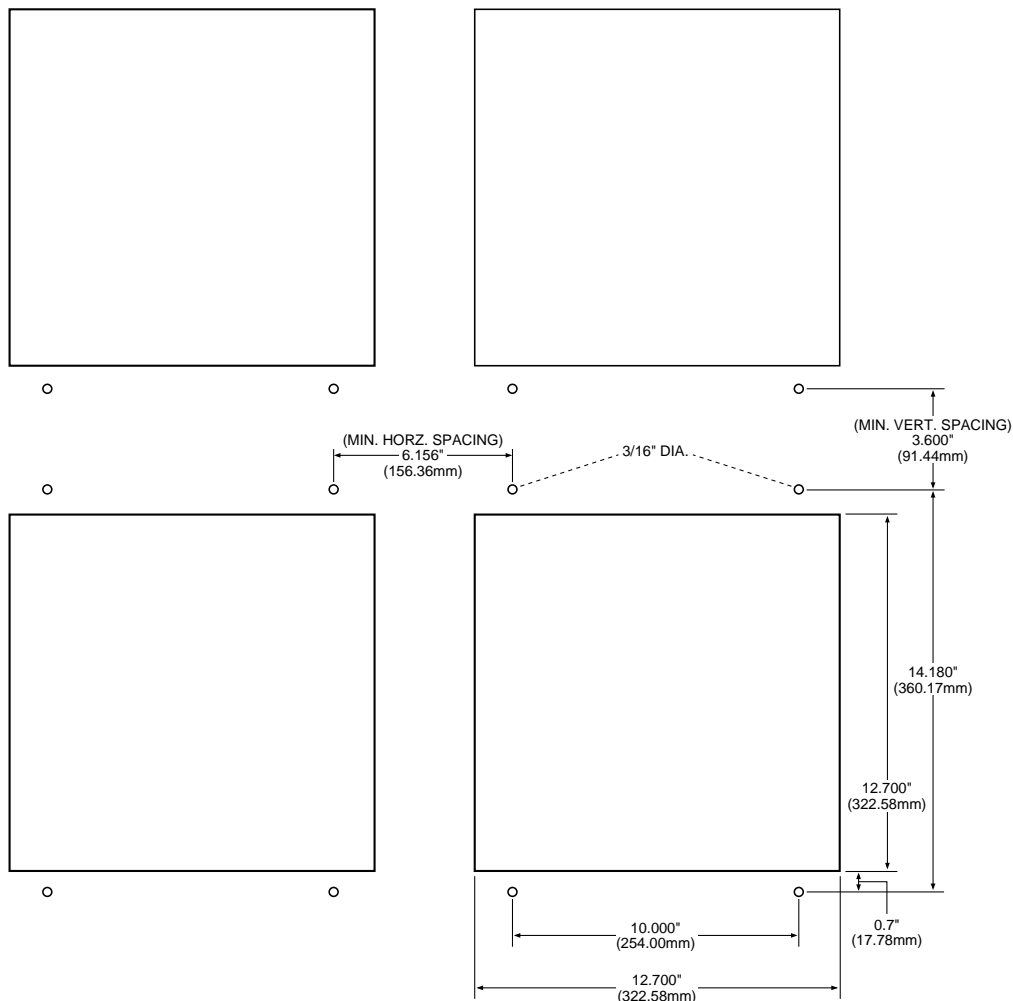

**FIGURE 2-1B**

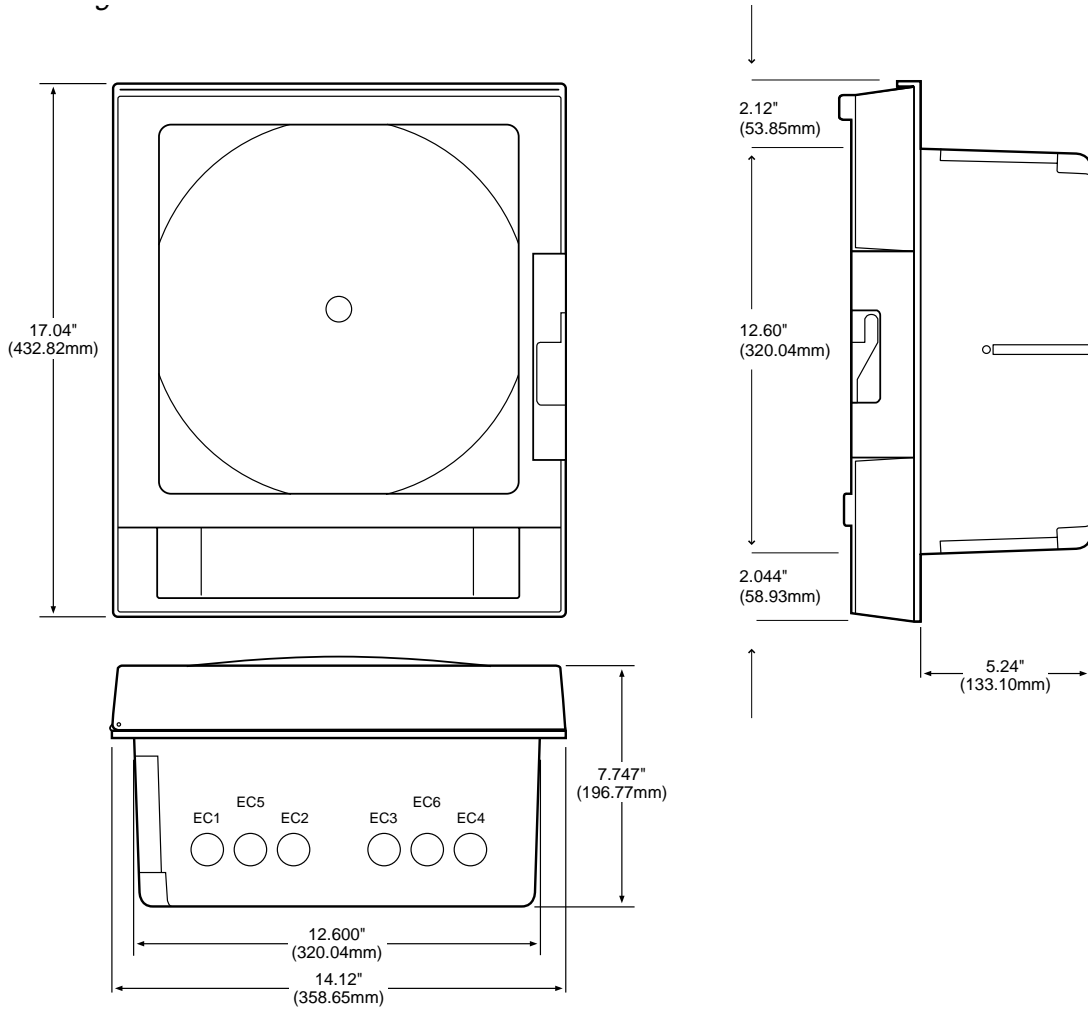

---

## 2.2 PREPARATION FOR WIRING

This product is in conformity with the protection requirements of EU Council Directive 89/336EEC on the approximation of the laws of the Member States relating to electromagnetic compatibility. The factory cannot accept responsibility for any failure to satisfy the protection requirements resulting from a non-recommended modification of this product.

Electrical noise is a phenomenon typical of industrial environments. The following are guidelines that must be followed to minimize the effect of noise upon any instrumentation.

### Installation Considerations

Listed below are some of the common sources of electrical noise in the industrial environment:

- Ignition Transformers
- Arc Welders
- Mechanical contact relay(s)
- Solenoids

Before using any instrument near the devices listed, the instructions below should be followed:

1. If the instrument is to be mounted in the same panel as any of the listed devices, separate them by the largest distance possible. For maximum electrical noise reduction, the noise generating devices should be mounted in a separate enclosure.
2. If possible, eliminate mechanical contact relay(s) and replace with solid state relays. If a mechanical relay being powered by an instrument output device cannot be replaced, a solid state relay can be used to isolate the instrument.
3. A separate isolation transformer to feed only instrumentation should be considered. The transformer can isolate the instrument from noise found on the AC power input.
4. If the instrument is being installed on existing equipment, the wiring in the area should be checked to insure that good practices have been followed.

### AC Power Wiring

#### Earth Ground

The instrument includes noise suppressing components that require an earth ground connection to function. To verify that a good earth ground is being attached, make a resistance check from the instrument chassis to the nearest metal water pipe or proven earth ground. This reading should not exceed 100 ohms. Each instrument should have a dedicated earth ground. Do not chain link multiple instrument ground wires.

#### Neutral (For 115 VAC)

It is good practice to assure that the AC neutral is at or near ground potential. To verify this, a voltmeter check between neutral and ground should be performed. On the AC range, the reading should not be more than 50 millivolts. If it is greater than this amount, the secondary of the AC transformer supplying the instrument should be checked by an electrician. A proper neutral will help ensure maximum performance from the instrument.

### Wire Isolation/Segregation

The instrument is designed to promote proper separation of the wiring groups that connect to the instrument. The AC power wire terminals are located near the bottom of the power supply board. The analog signal terminals are located near the bottom of the instrument boards. Maintain this separation of the wires to insure the best protection from electrical noise. If the wires need to be run parallel with any other wiring type(s), maintain a minimum 6 inch space between the wires. If wires must cross each other, do so at 90 degrees to minimize the contact with each other and reduce cross talk. Cross talk is due to the electro magnetic field induced by a wire as current passes through it.

### Use of Shielded Cable

Shielded cable helps eliminate electrical noise being induced on the wires. All analog signals should be run with shielded cable. Connection lead length should be kept as short as possible, keeping the wires protected by the shielding. The shield should be grounded at one end only. The preferred grounding location is at the sensor, transmitter or transducer.

### Noise Suppression at the Source

Usually, when good wiring practices are followed, no further noise protection is necessary. Sometimes in severe electrical environments, the amount of noise is so great that it has to be suppressed at the source. Many manufacturers of relays, contactors, etc. supply "surge suppressors" which mount on the noise source.

For those devices that do not have surge suppressors supplied, RC (resistance capacitance) networks and/or MOV (metal oxide varistors) may be added.

Inductive Coils - MOV's are recommended for transient suppression in inductive coils connected in parallel and as close as possible to the coil. See Figure 2-2 (below). Additional protection may be provided by adding an RC network across the MOV.

Contacts - Arcing may occur across contacts when the contact opens and closes. This results in electrical noise as well as damage to the contacts. Connecting a RC network properly sized can eliminate this arc.

For circuits up to 3 amps, a combination of a 47 ohm resistor and a 0.1 microfarad capacitor (1000 volts) is recommended. For circuits from 3 to 5 amps, connect 2 of these in parallel. See Figure 2-3 (below).

**FIGURE 2-2**

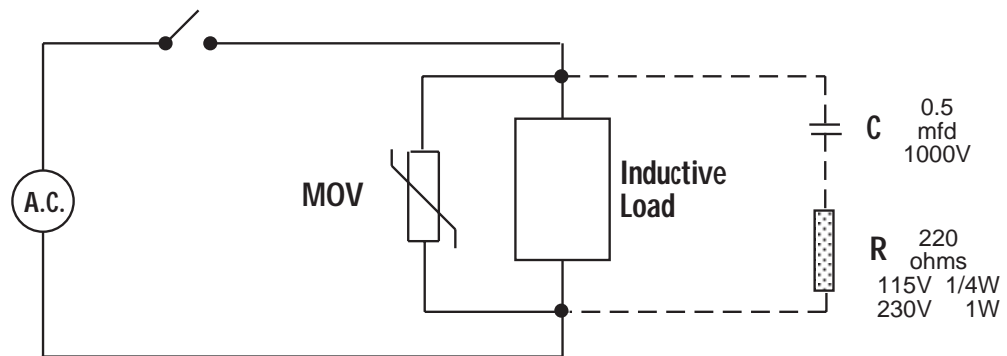

**FIGURE 2-3**

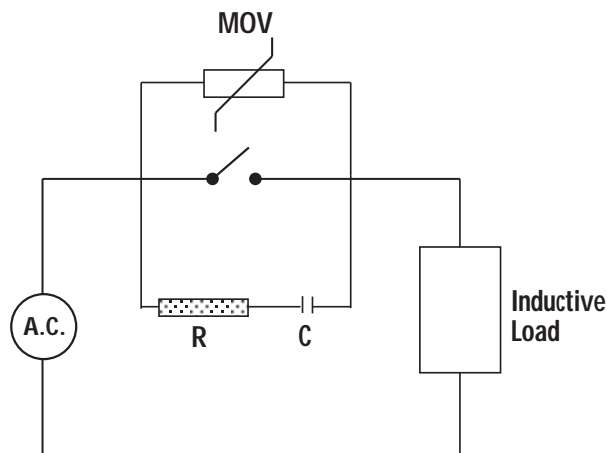

Sensor Placement (Thermocouple or RTD)

Thermocouple lead resistance should not exceed 300 ohms. If this is exceeded, instrument accuracy could be affected.

Two wire RTD's should be used only with lead lengths less than 10 feet.

If the temperature probe is to be subjected to corrosive or abrasive conditions, it should be protected by the appropriate thermowell. The probe should be positioned to reflect true process temperature:

In liquid media - the most agitated area

In air - the best circulated area



### 2.3 WIRING CONNECTIONS - INPUTS

All wiring connections are typically made to the instrument at the time of installation. Connections should be made at the terminal blocks, one 14 gauge wire maximum, using copper conductors except for thermocouple inputs. See Figure 2-4 (below) for the terminal block locations. The recommended torque for the AC Mains connector on the power supply board is 113oz-ins and the recommended torque for all other connectors in the unit is 85oz-ins.

**FIGURE 2-4**

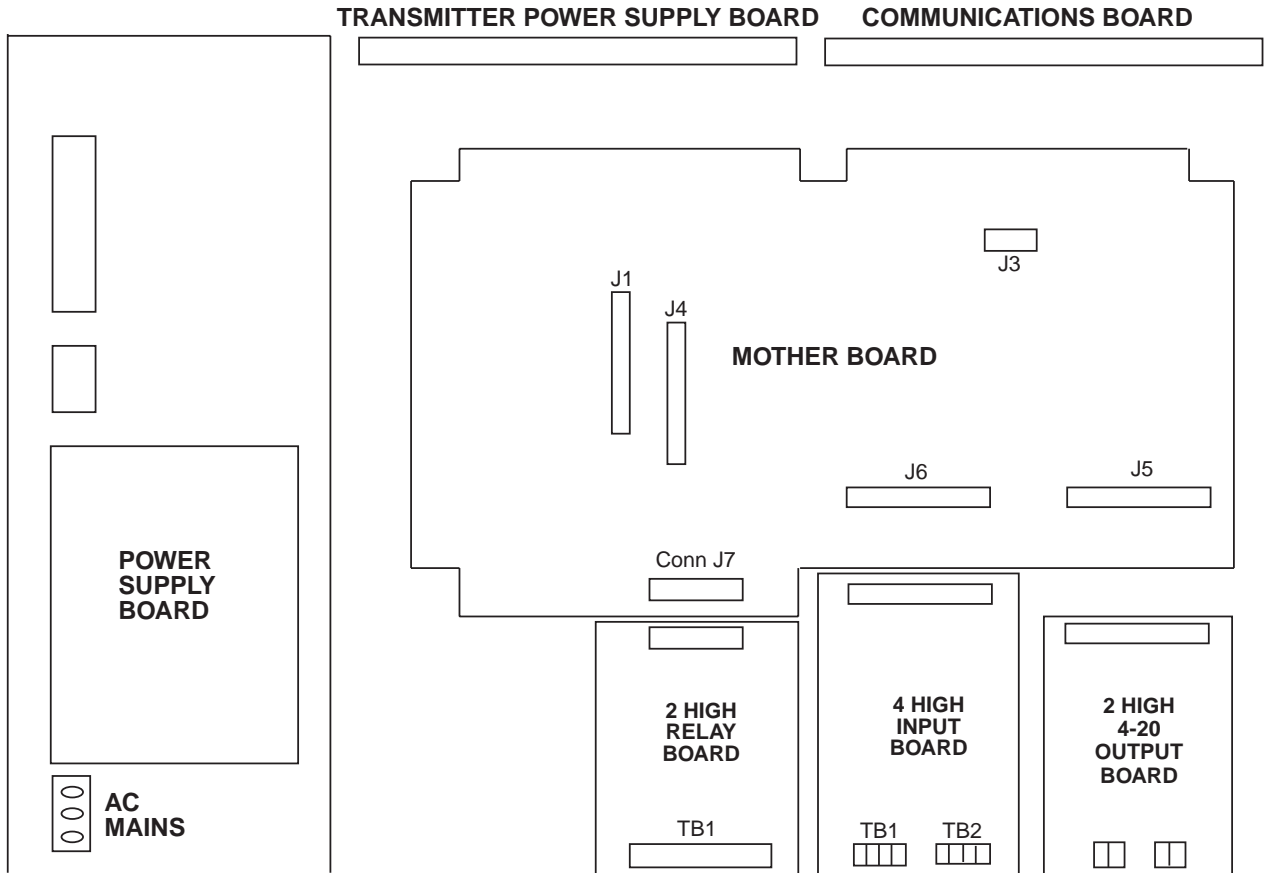

The instrument case may have numerous conduit openings, EC1 - EC6, depending upon the number of inputs and outputs specified (EC5 and EC6 are not included on all models). To help minimize electrical noise that may adversely affect the operation of the instrument, do not run input and/or 4-20mA output connections through the same conduit entry as relay or power supply connections. See Figure 2-1B (page 2-2) for conduit opening locations.

**2.3.1 SHIPPED CONFIGURATION/JUMPER POSITIONING**









Each instrument is factory shipped with all parameters set to default values. These defaults are shown in the "display" box for each parameter in Section 4.

Jumpers are used to condition the sensor inputs. All jumpers are located on the Input Board(s). The instrument is shipped from the factory with these jumpers configured as follows:

JU1	IF FITTED	UPSCALE BREAK
JU2		Non-Contact Closure Input
JU3		T/C, mV, 0/1V, Switch, mA
JU4	IF FITTED	UPSCALE BREAK
JU5		Non-Contact Closure Input
JU6		T/C, mV, 0/1V, Switch, mA
JU7		WIDE SPAN
JU8		WIDE SPAN
JU11	IF FITTED	Non-RTD
JU12	IF FITTED	Non-RTD
JU15		Non-mA
JU16		Non-mA

There are 2 additional jumpers per Input Board that are used for ID. These must be positioned as shown in Table 2-1 below as per their location inside the instrument. Board 1 is the bottom board.

**TABLE 2-1 BOARD ID JUMPERS**

	Inputs 1, 3, 5, 7	Inputs 2, 4, 6, 8
Board Position	JU13	JU14
Board 1		
Board 2		
Board 3		
Board 4		

If any board is removed from the instrument in a multiple stack of boards, it **MUST BE** installed in the correct sequence or these jumpers **MUST BE** moved. If not installed correctly, calibration will be affected.

**2.3.2 SENSOR BREAK and OUT-OF-RANGE DETECTION**

Sensor break and out-of-range conditions are determined and handled by the software. When either occurs, the software will drive the input value to +99999 or -99999 based upon whether SENSOR BREAK is software configured for UPSCALE or DOWN SCALE in Input Configuration. Any outputs will react accordingly. Out-of-range is defined as being more than 5% out of the span established by RANGE LIMIT LOW and RANGE LIMIT HIGH.

For 5 or 10 Volt and Current inputs, the analog signal goes to zero when there is a sensor break, due to voltage divider or shunt resistors. For sensor break detection to work on these input types, the INPUT RANGE LOW (analog signal low) and/or RANGE LIMIT LOW (engineering units low) parameters must be set high enough such that at zero volts/mA, the resultant value will be at least 5% below the span established by RANGE LIMIT LOW and RANGE LIMIT HIGH.

### 2.3.3 AC POWER CONNECTIONS

**WARNING: UNIT SHOULD HAVE A POWER SWITCH OR CIRCUIT BREAKER IN CLOSE PROXIMITY OF EQUIPMENT AND WITHIN EASY REACH OF THE OPERATOR. THE SWITCH SHALL BE MARKED AS THE DISCONNECTING DEVICE FOR THE UNIT.**

**FIGURE 2-6**

Connect the line voltage, hot and neutral, to L and N respectively. Connect the ground wire to the terminal labeled G.

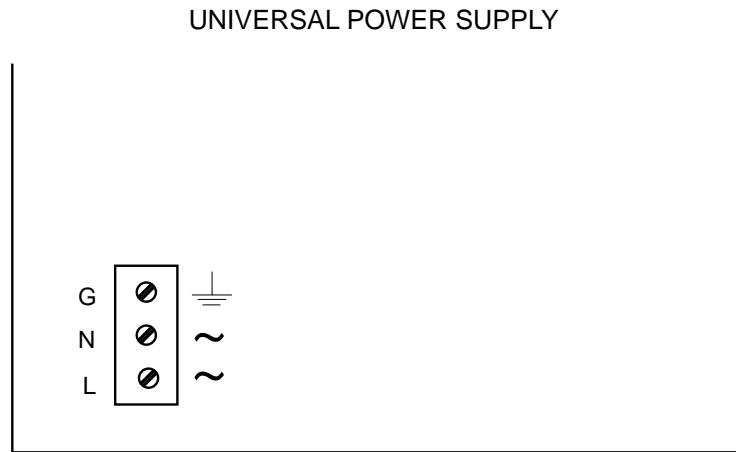

### 2.3.4 THERMOCOUPLE CONNECTIONS

**NOTE: Up to four Input Boards may be present; stacked 4 high. Input Board 1 is the bottom board. Two versions of Input Boards may be found, see Figure 2-7 and Figure 2-7A.**

Input Board 1 is used for Input 1 and, if equipped, Input 2. Input Board 2 is used for Input 3 and Input 4, if equipped. Input board 3 is for Input 5 and Input 6. Input Board 4 is for Input 7 and Input 8.

Connect the positive (+) leg of the thermocouple to terminal 1 and the negative (-) leg to terminal 2 on the Input Board(s) to be T/C. Terminal block 1 (TB1) is for Input 1, 3, 5, and 7 and terminal block 2 (TB2) is for Input 2, 4, 6, and 8.

**NOTE: INPUT CONDITIONING JUMPERS MUST BE POSITIONED AS SHOWN FOR A T/C INPUT IN EITHER FIGURE 2-7 OR 2-7A DEPENDING ON WHICH CIRCUIT BOARD IS FITTED. JUMPERS JU7/JU8 MAY BE MOVED TO THE NARROW SPAN POSITION FOR BETTER RESOLUTION IF THE MAXIMUM TEMPERATURE DOES NOT EXCEED THE UPPER SPAN LIMIT AS SHOWN IN APPENDIX B, PAGE B-1, AND THE THERMOCOUPLE BEING USED IS J, K, E, or N ONLY.**

**FIGURE 2-7**

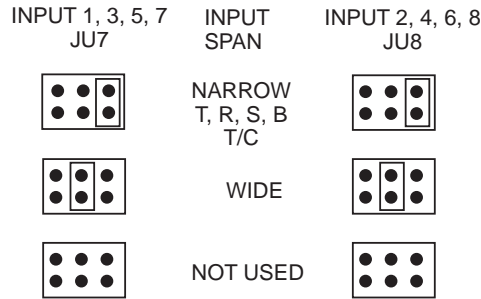

**FIGURE 2-7A**

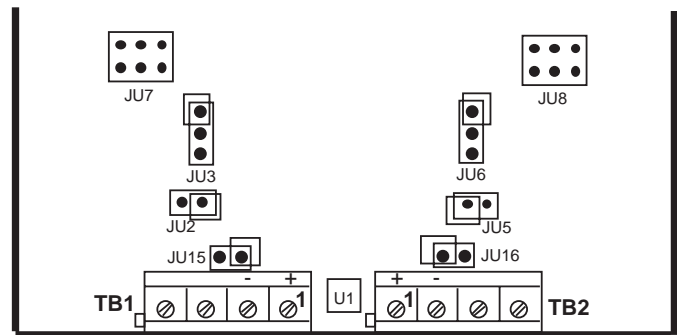
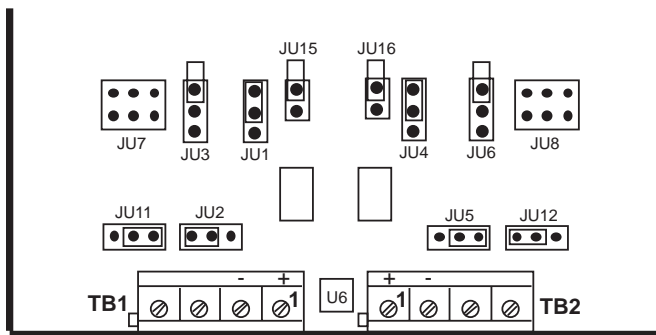
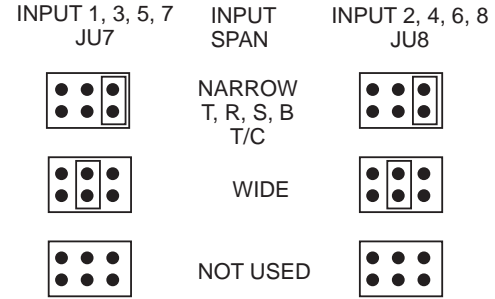

**NOTE: Terminal Block 1, Terminal 1 is on the RIGHT, Terminal Block 2, Terminal 1 is on the LEFT.**

### 2.3.5 RTD CONNECTIONS

**Note:** Up to four Input Boards may be present; stacked 4 high. Input Board 1 is the bottom board. Two versions of Input Board s may be found, see Figure 2-8 and Figure 2-8A.

Input Board 1 is used for Input 1 and, if equipped, Input 2. Input Board 2 is used for Input 3 and Input 4, if equipped. Input Board 3 is for Input 5 and Input 6. Input Board 4 is for Input 7 and Input 8.

Connect 2 wire RTD inputs to terminals 3 and 4 on the Input Board(s) to be RTD. Install a jumper between terminals 2 and 3. Terminal block 1 (TB1) is Input 1, 3, 5 and 7 and terminal block 2 (TB2) is Input 2, 4, 6, and 8.

Connect 3 wire RTD inputs to terminals 2, 3 and 4 (common legs on terminals 2 and 3) on the Input Board(s) to be RTD. Terminal block 1 (TB1) is Input 1, 3, 5, and 7 and terminal block 2 (TB2) is Input 2, 4, 6, and 8.

**NOTE: INPUT CONDITIONING JUMPERS MUST BE POSITIONED AS SHOWN FOR AN RTD INPUT IN EITHER FIGURE 2-8 OR 2-8A DEPENDING ON WHICH CIRCUIT BOARD IS FITTED.**

**FIGURE 2-8**

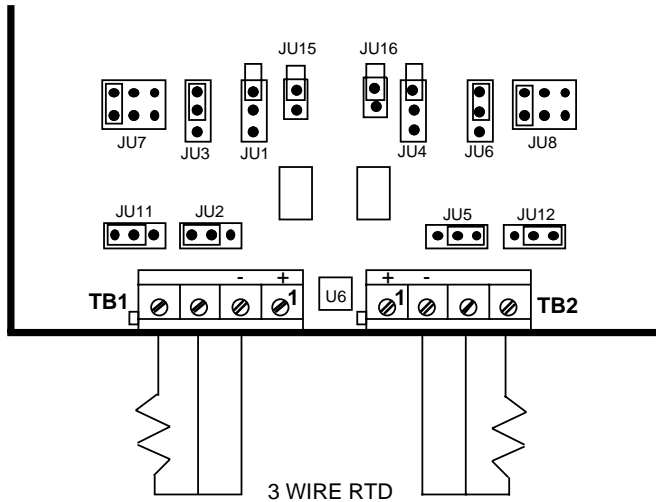

**FIGURE 2-8A**

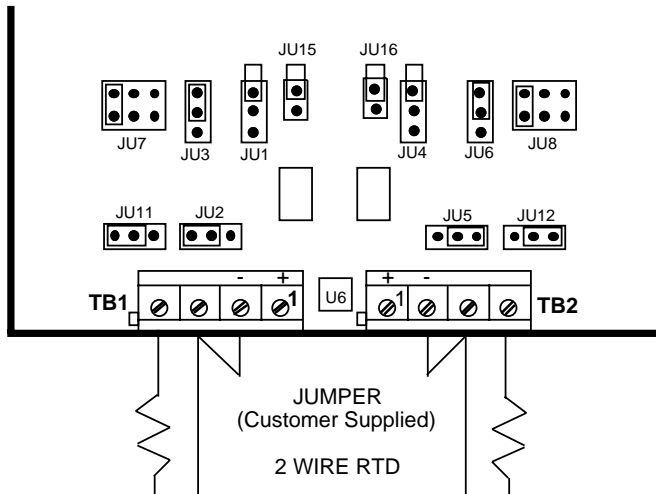
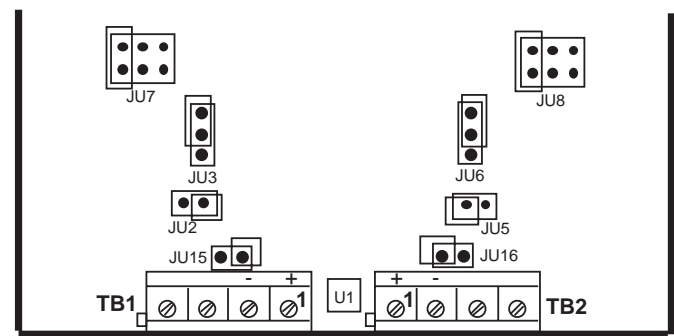

**NOTE: Terminal Block 1, Terminal 1 is on the RIGHT, Terminal Block 2, Terminal 1 is on the LEFT.**

### 2.3.6 VOLTAGE CONNECTIONS

**Note:** Up to four Input Boards may be present; stacked 4 high. Input Board 1 is the bottom board. Two versions of Input Board s may be found, see Figure 2-9 and Figure 2-9A.

Input Board 1 is used for Input 1 and, if equipped, Input 2. Input Board 2 is used for Input 3 and Input 4, if equipped. Input Board 3 is for Input 5 and Input 6. Input Board 4 is for Input 7 and Input 8.

Connect positive (+) leg to terminal 1 and negative (-) leg to terminal 2 on the Input Board(s) to be volt input. Terminal block 1 (TB1) is Input 1, 3,5 and 7 and terminal block 2 (TB2) is Input 2, 4, 6, and 8.

**NOTE: INPUT CONDITIONING JUMPERS MUST BE POSITIONED AS SHOWN FOR VOLT INPUT IN EITHER FIGURE 2-8 OR 2-8A DEPENDING ON WHICH CIRCUIT BOARD IS FITTED. ALSO NOTE: THERE IS NO SENSOR BREAK DETECTION FOR ZERO BASED VOLT INPUTS. EXAMPLE: 0-5V.**

**FIGURE 2-9**

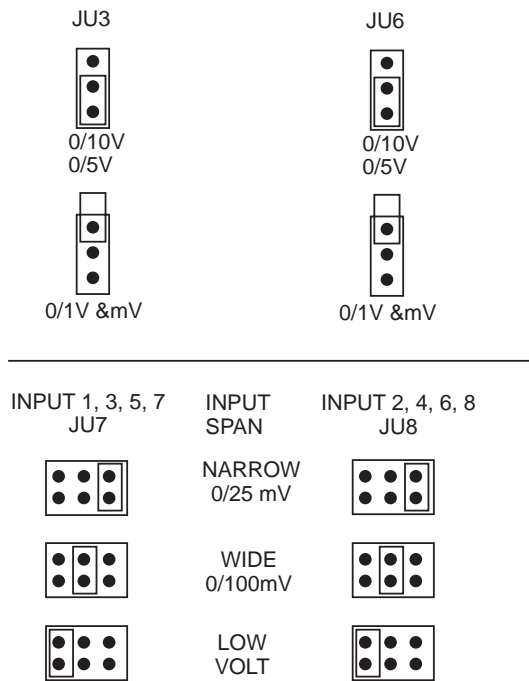

**FIGURE 2-9A**

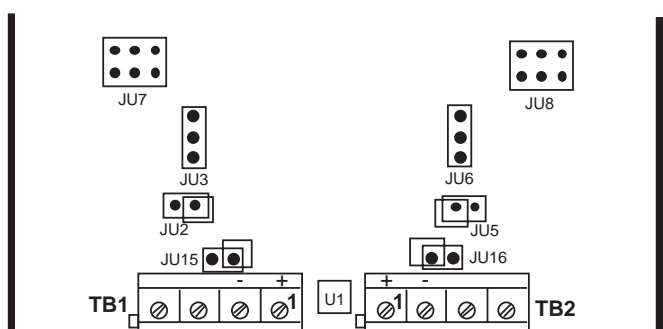
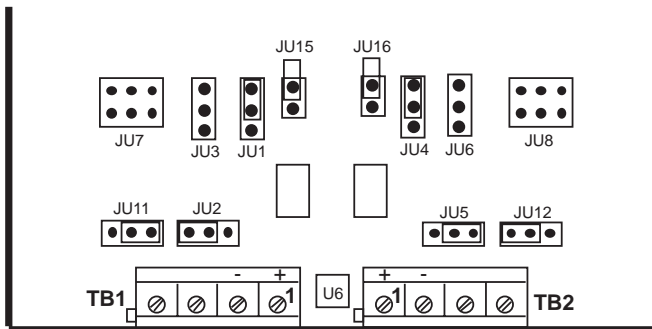
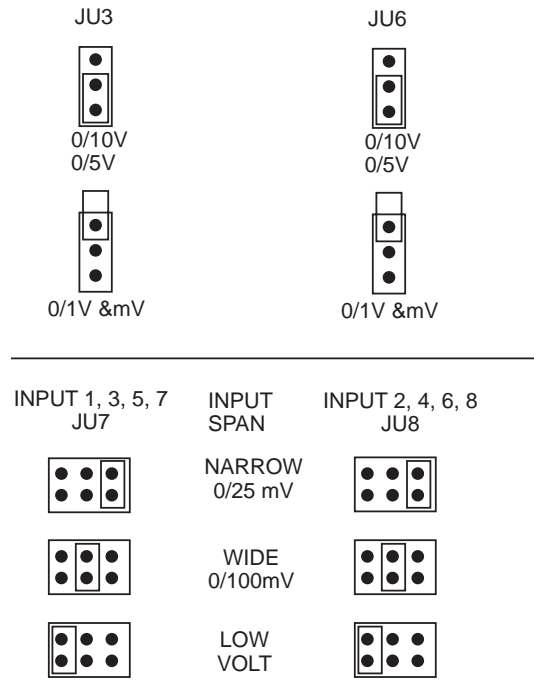

**NOTE:** Terminal Block 1, Terminal 1 is on the RIGHT, Terminal Block 2, Terminal 1 is on the LEFT.

### 2.3.7 CURRENT CONNECTIONS

**Note:** Up to four Input Boards may be present; stacked 4 high. Input Board 1 is the bottom board. Two versions of Input Board s may be found, see Figure 2-10 and Figure 2-10A.

Input Board 1 is used for Input 1 and, if equipped, Input 2. Input Board 2 is used for Input 3 and Input 4, if equipped. Input Board 3 is for Input 5 and Input 6. Input Board 4 is for Input 7 and Input 8.

Connect positive (+) leg to terminal 1 and connect negative (-) leg to terminal 2 on the Input Board(s) to be current input. Terminal block 1 (TB1) is Input 1, 3, 5, and 7 and terminal block 2 (TB2) is Input 2, 4, 6, and 8.

Installation of an appropriate shunt resistor is NOT REQUIRED. Positioning JU15/16 properly connects the appropriate shunt resistor that is populated on the Input Board.

**NOTE: INPUT CONDITIONING JUMPERS MUST BE POSITIONED AS SHOWN FOR CURRENT INPUT IN EITHER FIGURE 2-8 OR 2-8A DEPENDING ON WHICH CIRCUIT BOARD IS FITTED. ALSO NOTE: THERE IS NO SENSOR BREAK DETECTION FOR ZERO BASED CURRENT INPUTS. EXAMPLE: 0-20MA.**

**FIGURE 2-10**

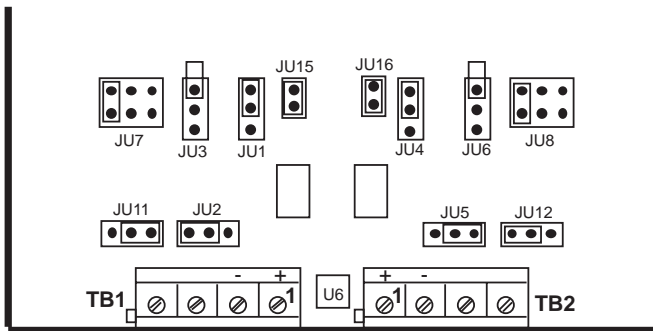

**FIGURE 2-10A**

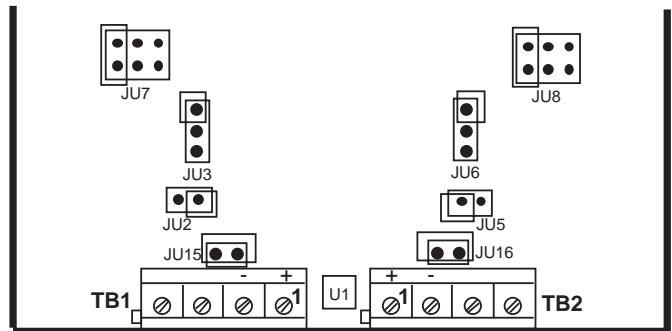

**NOTE:** Terminal Block 1, Terminal 1 is on the RIGHT, Terminal Block 2, Terminal 1 is on the LEFT.

### 2.3.8 SWITCH INPUT CONNECTIONS

**Note:** Up to four Input Boards may be present; stacked 4 high. Input Board 1 is the bottom board. Two versions of Input Board s may be found, see Figure 2-10 and Figure 2-10A.

Input Board 1 is used for Input 1 and, if equipped, Input 2. Input Board 2 is used for Input 3 and Input 4, if equipped. Input Board 3 is for Input 5 and Input 6. Input Board 4 is for Input 7 and Input 8.

Connect one leg to terminal 1 and connect the other leg to terminal 2 on the Input Board(s) to be switch input. Terminal block 1 (TB1) is Input 1, 3, 5, and 7 and terminal block 2 (TB2) is Input 2, 4, 6, and 8.

**NOTE: INPUT CONDITIONING JUMPERS MUST BE POSITIONED AS SHOWN FOR SWITCH INPUT IN EITHER FIGURE 2-8 OR 2-8A DEPENDING ON WHICH CIRCUIT BOARD IS FITTED.**

**FIGURE 2-11**

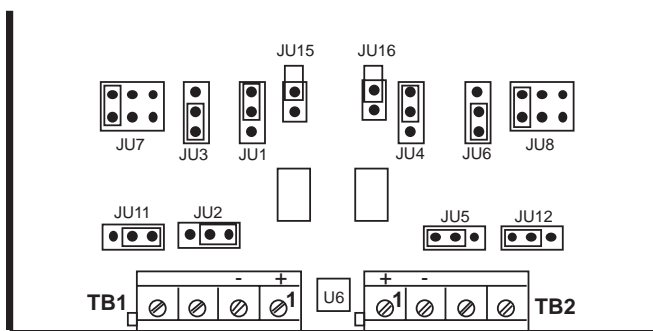

**FIGURE 2-11A**

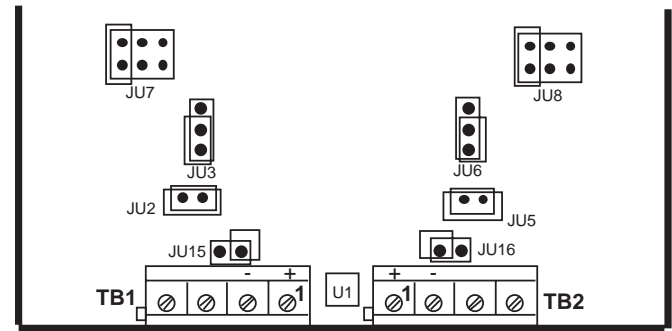

**NOTE:** Terminal Block 1, Terminal 1 is on the RIGHT, Terminal Block 2, Terminal 1 is on the LEFT.



## 2.4 WIRING CONNECTIONS - OUTPUTS

Relay output(s), if provided, may be assigned to any actuator, which includes alarms and/or optional control capability. Current output(s), if provided, may be assigned to any analog value, which includes derived and process values for retransmission or control. Assignment of the function is accomplished in Configuration.

### 2.4.1 SPDT RELAY OUTPUT

**Note:** Up to two Boards may be present; stacked 2 high. Board 1 is the bottom board.

SPDT and/or SSR driver outputs is/are designated as Relay 1 through Relay 8. Relay 1 through Relay 4 are located on Board 1 and Relay 5 through Relay 8 (if provided) are located on Board 2. See Figure 2-4, page 2-6.

Connections are made as shown. Terminal connections are made using TB1 thru TB4, Relay 1 thru Relay 4 respectively.

**FIGURE 2-12**

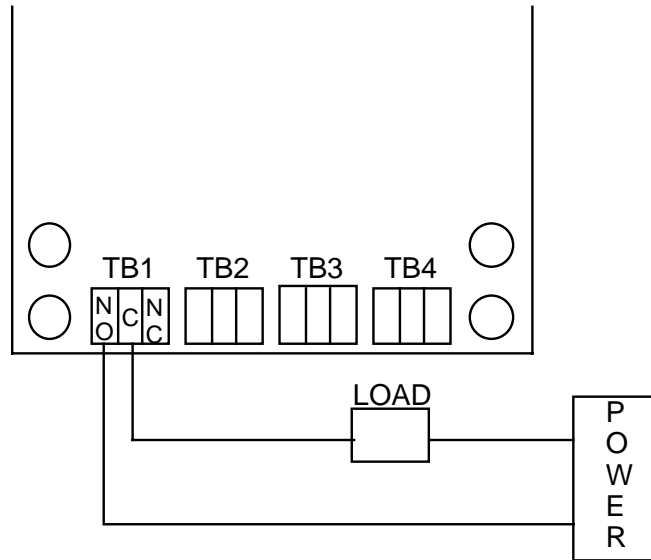

### 2.4.2 SSR DRIVER OUTPUT

**Note:** Up to two Boards may be present; stacked 2 high. Board 1 is the bottom board.

Connections are made as shown. Terminal connections are made using TB1 thru TB4, Relay 1 thru Relay 4 respectively.

**FIGURE 2-13**

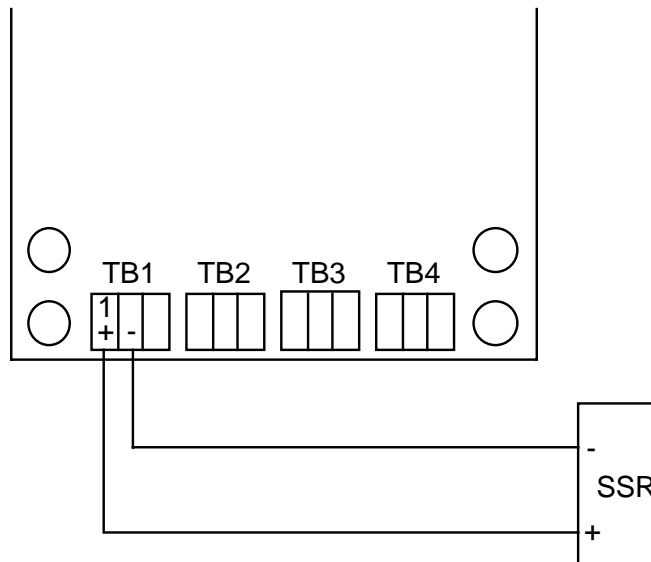

### 2.4.3 CURRENT OUTPUT

**Note:** Up to two boards may be present, stacked 2 high. Board 1 is the bottom board. Non-isolated and isolated outputs are available.

#### Non-isolated

Non-isolated current outputs are designated as current output 1 through current output 2. Current output 1 is located on Board 1 and Current Output 2 is located on Board 2.

Connections are made as shown. Terminal connections are made using TB1, terminal 1 is positive and terminal 2 is negative.

**FIGURE 2-14**

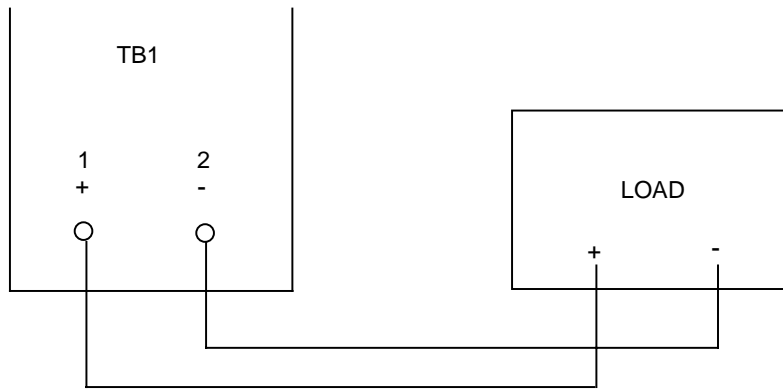

#### Isolated

Isolated current outputs are designated current output 1 through current output 4. Current output 1, and if specified, current output 2, are located on board 1. Current outputs 3 and 4, if specified, are located on board 2.

Connections are made as shown. Terminal connections are made using TB1 (output 1 and 3), terminal 1 is positive and terminal 2 is negative, and TB2 (output 2 and 4), terminal 1 is positive and terminal 2 is negative.

**FIGURE 2-14B**

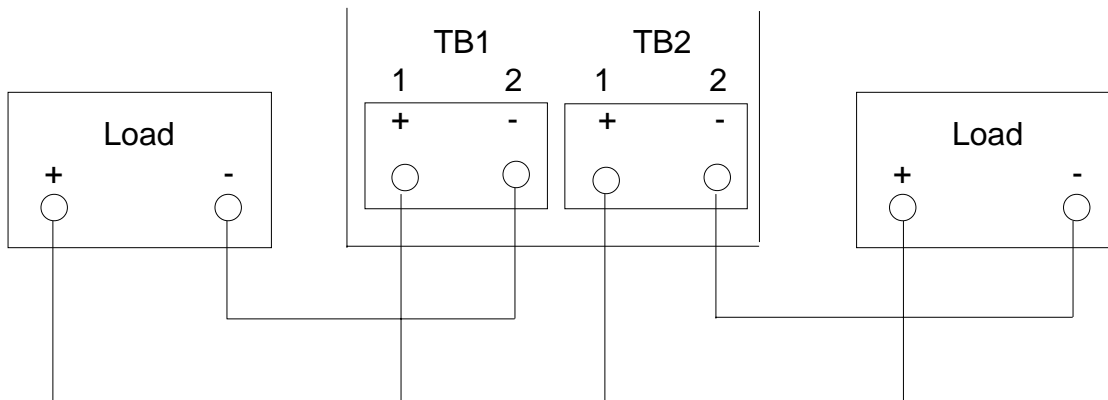

#### **2.4.4 24VDC TRANSMITTER POWER SUPPLY**

**Note:** Up to four transmitter power supplies may be present. One transmitter can provide up to 25mA of current at 24 VDC.

Transmitter outputs are designated as Transmitter Output 1 through Transmitter Output 4. Transmitter Output 1 is at TB1, Transmitter Output 2 is at TB2, Transmitter Output 3 is at TB3 and Transmitter Output 4 is at TB4.

If an isolated 24 VDC regulated transmitter power supply has been specified, the connections should be made as shown.

**FIGURE 2-15A**

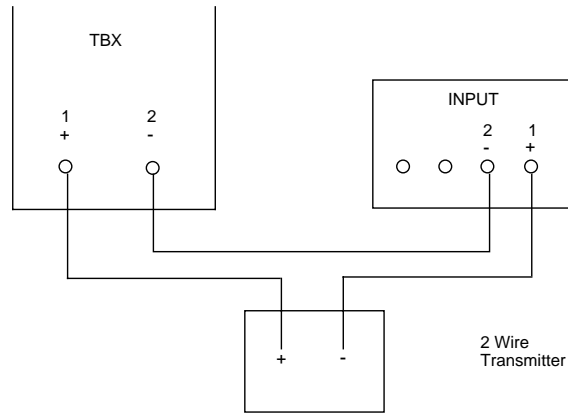

#### **2.4.5 COMMUNICATIONS**

The connections should be made as shown: Terminal block TB1 is used for RS-232 (Figure 2-15B) and terminal block TB3 is used for RS-485 (Figure 2-15c). Jumpers JP1 and JP3 must be positioned as shown.

**FIGURE 2-15B**

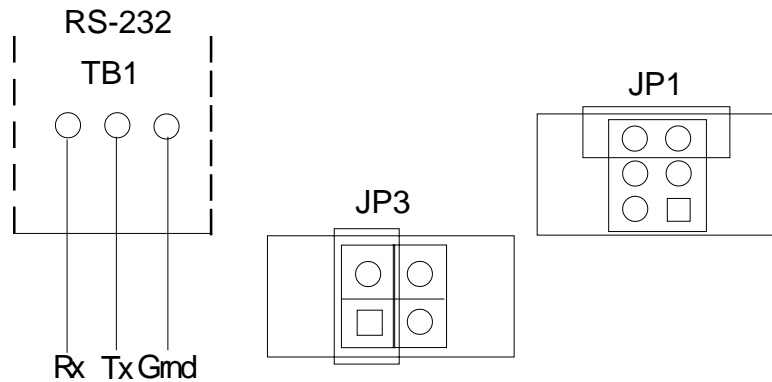

**FIGURE 2-15C**

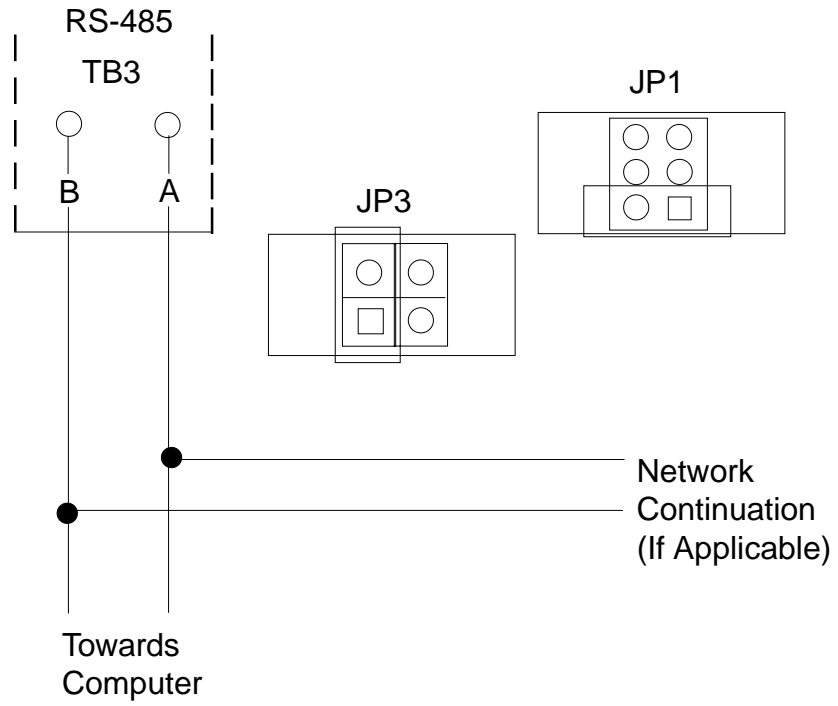

---

## Section 3 - The Basics of Recorder Operation

---

### 3.1 POWER-UP

After proper installation, the following will occur when power is applied:

- All segments in the vacuum fluorescent display will light, then
- All the display LEDs will light, then
- The instrument tag and the current time and date will appear.

When completed, the instrument begins normal display mode as configured in Display Programming and configuration.

---

### 3.2 INSTRUMENT MODES

The instrument incorporates a multilevel prompting scheme. The Display, Chart and Scroll keys are used to gain access to each of the three prompting sections of the unit. When the instrument is not in one of the prompt sections, it is considered to be in the Normal Display mode.

#### 3.2.1 NORMAL DISPLAY

The Normal Display is the normal operator mode for the recorder and display. In Normal Display, the instrument can provide various displays of Instrument Tag/Time/Date, Input Values, Derived Values, Process Values, and other values that may be added to the Display Sequence in Configuration. In Normal Display the instrument may be in Sequential (automatic advance) or Continuous (manual advance) display mode.

#### 3.2.2 DISPLAY PROMPTS

The Display Prompts provides access to all display related configuration functions and operator inputs. The Display Prompts section contains only one level.

#### 3.2.3 CHART PROMPTS

The Chart Prompts provides access to all chart related configuration functions and also the prompts for changing the chart.

The Chart Prompts section contains two levels. With CHART CONFIGURATION displayed, the Down Arrow key will access that section of prompts, which will be one level down. While in CHART CONFIGURATION, the Scroll and Left Arrow keys will move through the parameter choices, and the Up Arrow key will return to the previous level, which will be one level up.

#### 3.2.4 SYSTEM PROMPTS

The Select System Prompts provides access to alarm settings, enables/passwords, configuration/setup, test, calibration, etc.

The System Prompts section contains up to two levels. For example, with CONFIGURATION displayed, the Down Arrow key will access the next level of prompts, where INPUTS can be selected. With INPUTS displayed, the Down Arrow key will access the next level of prompts, where the input parameters can be accessed. Pressing the Up Arrow key would return to the previous level, INPUTS, and pressing the Up Arrow key again would return to the previous level, CONFIGURATION, and pressing the UP Arrow key again would return to the Normal Display mode.

## 3.3 KEYPAD FUNCTION

FIGURE 3-1

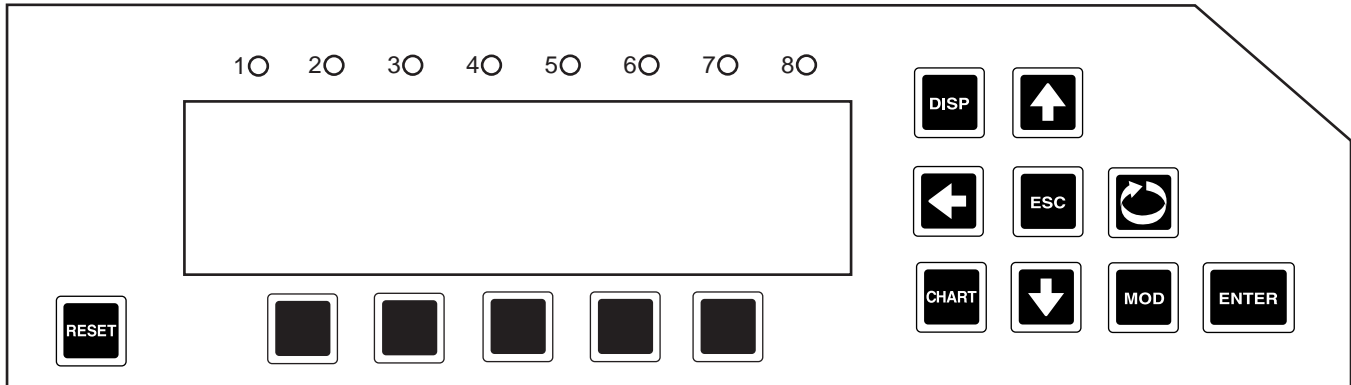

### 3.3.1 DISPLAY KEY (DISP)

While in Normal Display, the Display key initiates the Display Prompts and is used to step through the Display Prompts.

### 3.3.2 CHART KEY (CHART)

While in Normal Display, the Chart key initiates the Chart Prompts and is used to step through the Chart Prompts.

### 3.3.3 SCROLL KEY

While in Normal Display, the Scroll key initiates the System Prompts. While in any prompt section, the Scroll key advances through the choices of other prompt sections or parameters and settings, at the current level. The Scroll key is also used to move the cursor to the right while in Modify.

### 3.3.4 ARROW KEYS

- While in Normal Display with the Sequential Display active, the arrow keys will cause no action.
- While in Normal Display with the Continuous Display active, the Up or Down Arrow keys will step backward or forward through items in the Display Sequence.
- While in any prompt section the Left Arrow and Scroll keys will step backward and forward through the selections at that level. The selections wrap around at the ends. The Down Arrow key steps down (or forward) one level. The Up Arrow key steps up (or backward) one level. If the prompting is at the top (or first) level, the Up Arrow key will return the unit to Normal Display.
- The Arrow keys repeat, when held down, every half second after the first second.
- The unit remembers the path taken through the System and Display prompts. That is, by returning to Normal Display by successive depressions of the Up Arrow key, the operator can return to the same point by entering the corresponding prompts section and successive depressions of the Down Arrow key.

### 3.3.5 RESET KEY (RESET - special key located on lower left)

While in a prompt section, the Reset key returns the unit to Normal Display and resets the path pointers to the initial conditions.

### 3.3.6 ESCAPE KEY (ESC), MODIFY KEY (MOD), ENTER KEY (ENTER)

- While a modifiable parameter description and its setting are displayed, pressing the MOD key places the unit in Modify where the setting can be modified or changed.
- Pressing the ESC key will exit Modify and the original value will be displayed, no change being made to it.
- Pressing the ENTER key will exit Modify and the new value will be displayed and entered into memory.

### 3.3.7 SPECIAL KEYS (five keys located below the display)

While in the Multiple Choice Selection, the Special keys are used to select 1 of up to 5 choices from a choice line displayed directly above each key.

---

## 3.4 CHANGING PARAMETER SETTINGS - MODIFY

There are three types of parameters in the instrument: values (numbers), text strings (groups of characters), and choices (selections made by picking one of a group of displayed descriptions).

With a modifiable parameter description and its setting displayed, pressing the MOD key places the unit in Modify where the setting can be modified.

### 3.4.1 CHANGING VALUES

If the setting is a value (number), the cursor will be positioned on the right-most digit. The LEFT ARROW and SCROLL keys will move the cursor left or right. The UP and DOWN keys will increment or decrement the value with rollover and rollunder through all digits to the left of the cursor. Pressing the ESC key exits Modify, no change being made to the original value. Pressing the ENTER key exits Modify and the new value will be displayed and entered into memory.

### 3.4.2 CHANGING TEXT

There are two ways to change or modify text. The first, Character Modify, is accessed by the initial pressing of the MOD key, and the second, Character Selection, is accessed by pressing the MOD key while being in the Character Modify mode. Each has its benefits, and you may prefer to use one or both methods, depending on the modification to be made. Pressing the RESET key after pressing the MOD key will clear all characters from the cursor to the right.

- If the setting is text ( e.g. units, tag, etc.), the text will be left justified and the cursor will be positioned on the left-most character. The LEFT ARROW and SCROLL keys will move the cursor left or right.
- In Character Modify, the UP and DOWN ARROW keys change the character by scrolling through a list or string of available characters. The LEFT ARROW and SCROLL keys will move the cursor left and right to allow changing another character. Pressing the MOD key enters Character Selection. Pressing the ESC key exits Modify, no change being made to the string. Pressing the ENTER key exits Modify and the new string will be displayed and entered into memory.
- In Character Selection, depressing the MOD key twice will initiate Character Selection. The character to be changed (on the lower line) will be replaced by the "block" character (all dots lit), and the upper display line will show a character selection line, instead of the parameter description. The character selection line which contains the current character will be displayed with the cursor positioned on the current character. The LEFT ARROW and SCROLL keys will move the cursor left and right on the current character selection line. The UP and DOWN ARROW keys will change the line of characters displayed for selection. Once the cursor is positioned on the desired character, pressing the MOD key will store the desired character in the lower line, the "block" character will move to the next position on the second line, and the character selection line which contains the next character will be displayed with the cursor positioned on that character.
- While in Character Selection, pressing the ESC key exits Character Selection and returns the unit to Character Modify where selection of another character may be made or pressing the ESC key again exits Modify.
- While in Character Selection, pressing the ENTER key after modifying a character will exit Character Selection and the new string will be displayed and entered into memory.

### 3.4.3 CHANGING CHOICES

• If the setting is a YES/NO choice, the YES/NO choice line will be displayed and the current choice will blink. The LEFT ARROW and SCROLL keys will switch the selection between YES and NO. Selecting the choice and pressing ENTER will exit Modify and the new setting will be displayed and entered into memory. Some YES/NO parameter choices are initialized to NO. When changed to YES, the unit may automatically advance to the next parameter upon depression of the ENTER key.

(Continued on next page)

- If the setting is one of a list of choices, the choice line containing the current choice will be displayed and the current choice will blink. If multiple choices are displayed, the LEFT ARROW or SCROLL keys will move the selection to the left or right. If all choices are not displayed at once, due to multiple choice lines, the UP ARROW key will step backward to the previous choice line, or the DOWN ARROW key will step forward to the next choice line. Pressing the ESC key will exit Modify and the original setting will be displayed, no change being made to it. Pressing the ENTER key will exit Modify and the new setting will be displayed and entered into memory.
- A choice line may offer 1 through 5 choices. Pressing the Special key located directly below the desired choice, will select and enter that choice into memory.

#### 3.4.4 COPY/INITIALIZE

A COPY/INITIALIZE capability is available with some parameter sections. If COPY is selected, the unit automatically goes into Modify on its associated value and uses its associated number as an index and copies data from one set of elements into the current set of elements. If the associated number is set to zero, the factory default values are stored into the selected set of elements (INITIALIZE). The COPY function applies to all parameter entries following it until the next non-parameter entry.

#### 3.4.5 PASSWORDS

Where PASSWORDS apply, they are not displayed if the current value of the password is zero. If PASSWORDS are not zero, and the value is set to the correct password, the unit automatically proceeds to the next parameter entry. If PASSWORDS are not zero, and the value is set to the incorrect password, the message "INVALID PASSWORD" will appear in the upper display.

#### 3.4.6 ENABLES

If Chart Prompts is DISABLED, when the CHART key is pressed, the message "CHART KEY DISABLED" will appear in the lower display. If Display Prompts is DISABLED, when the DISP key is pressed, "DISPLAY KEY DISABLED" will appear in the lower display. If other parameters are DISABLED, their corresponding prompts will not be displayed.

---

### 3.5 THE DISPLAY

During normal operation, the display shows data according to the setup determined by the settings in Display and Configuration prompts.

The display has 2 lines of 20 characters with 8 status indicators.

The display may be configured as continuous or sequential, as well as 1 value at a time, 2 values at a time, or 4 PVs at a time. Refer to Section 3.7 for details.

---

### 3.6 GENERAL

After completing installation and wiring of the instrument, the configuration procedures must be performed to prepare the instrument for operation on the intended application. The procedures include selecting specific prompts/parameters, entering data and possible jumper positioning. Once properly configured the instrument will retain the selections in memory. Not all selections are applicable for every recorder.

**Note: Before configuring, it is recommended that the Software Reference/Record Sheets (found at the end of this section) be completely filled in.**

Parameter selections and data entry are made via the keypad. To ease configuration and operation, user entered data has been divided up into three sections referred to as Main Prompts. The three are: System, Display, and Chart. Each prompt contains different type of data; chart for the chart, Display for the Display, and System, as follows:

CONFIGURATION--ACTION TIME SETTINGS--ALARM SETTINGS--ENABLES/PASSWORDS--TEST--  
CALIBRATION--MODEL/REV



ACTION TIME SETTINGS	Selections made in action time settings are used to generate actuators that are true/false based on times and/or dates.
ALARM SETTING	Selections made in alarm settings determine the setpoint of each alarm configured.
ENABLES/PASSWORDS	Selections made in enables/passwords provide means of enabling or disabling certain prompts or selections AND provides additional security with the use of 6 digit passwords restricting access to Chart, Display, Enables/Passwords and MAIN Prompts selections.
CONFIGURATION	Selections made in configuration set up the instrument for proper operation.
TEST	Routines used to test the relays and chart.
CALIBRATION	Routines used to calibrate the instrument.
MODEL/REV	Deciphered to determine whether certain prompts or sections are shown/displayed and revision of the software.

---

### 3.7 DISPLAY DETAILS

The instrument will spend most of the time in Normal Display. When in Normal Display, it can provide various displays of instrument tag, input values, simulated values, derived values, process values, and other values that may be added to the Display Sequence in Configuration, or it may display active operator messages. In Normal Display, the instrument can also be in one of two conditions, Sequential or Continuous Display.

The display provides upper case letters only, with a few exceptions for engineering units.

The following is the format for the instrument tag and times and dates:

tag	hh - hours
hh:mm aa bb/cc/yy 📢	mm - minutes
	aa - AM or PM if not 24 hour
	bb - month if MM:DD:YY format
	day if DD:MM:YY format
	cc - day if MM:DD:YY format
	month if DD:MM:YY format
	yy - year
	📢 - global alarm indicator
	or for the third date format

tag	dd - day
hh:mm aa dd mmm yy 📢	mmm - month in 3 character format

For Instrument tag, the "tag" is the INSTRUMENT TAG from the INSTRUMENT SETTINGS prompts section, and for ACTION TIME SETTINGS, the "tag" is TIME 1 TAG or TIME 2 TAG from the ACTION TIME SETTINGS prompts section.

(Continued on next page)



Whenever the display format is other than "1 VAL" at a time, the different types are not intermixed in any given display step, consequently the second line may be blank.

### SEQUENTIAL DISPLAY

With Sequential Display active, the instrument provides a sequential display of all input, simulated, derived, and process values that have their Display Option set to "IN SEQUENTIAL MODE" or "IN BOTH MODES". The rate of sequencing is programmable from 1 to 8 seconds.

### CONTINUOUS DISPLAY

With Continuous Display active, the instrument continuously displays a single step of the Display Sequence for all input, simulated, derived, and process values that have their Display Option set to "IN CONTINUOUS MODE" or "IN BOTH MODES". The UP and DOWN keys will step backward or forward through the list.

---

## **3.8 CHART DETAILS**

The CHART TYPE is user selectable from one of three choices:

1. RINGS/LINES/SCALES preprinted  
Rings - concentric rings  
Lines - time lines  
Scales - scale numbers
2. RINGS AND TIME LINES preprinted
3. RINGS ONLY preprinted

The RECORDING METHOD choices, user selectable per pen are as follows, using a 24 hour rotation for example, with spokes recorded every 24 seconds.

1. INSTANTANEOUS VALUES - records the instantaneous value at 24 second intervals.
2. CONNECT THE VALUES - records the instantaneous value at 24 second intervals, but includes dots between successive values.
3. DRAG - MIN TO MAX - records the minimum and maximum values during the 24 second interval and includes dots between the values.
4. AVERAGE VALUES - records the average of the values during the 24 second interval.
5. CONNECT THE AVERAGES - records the average of the values during the 24 second interval, but includes dots between successive averages.

Major time lines are printed as a series of dots, with noticeable spacing, and extend from the inner chart ring to the outer chart ring. The number of major time lines printed on the chart is determined by the MAJOR TIME PERIODS parameter in the CHART CONFIGURATION prompts section. The color of the major time line is programmable.

Scale lines are printed as a series of dots, closely spaced to form a solid line, and are printed only in the area of the chart (zone or portion of chart span) used for the respective trend line. The scale lines are printed on top of major time lines. The number of scale lines printed on the chart is determined by the MAJOR TIME PERIODS parameter, the number of BLANK MAJOR TIME PERIODS, and the number of trend lines being recorded. The color of the scale line is the same as the respective trend line.

Minor time lines are printed as a series of dots, with spacing greater than major time lines and extend from the inner chart ring to the outer chart ring. The number of minor time lines printed on the chart between the major time lines is determined by the MINOR TIME PERIODS parameter in the CHART CONFIGURATION prompts section and is one less than the number of periods selected.

Trends can be zoned into two different areas to allow for higher resolution on one end of the recorded span. The recorded area used on the chart for a trend may not necessarily use the entire area available for recording.

Engineering unit values are printed next to the corresponding scale lines. The ZONE 1 LOW DIVISION parameter in RECORDERS section of CONFIGURATION specifies the position on the chart corresponding to the bottom of zone 1 and the ZONE 1 HIGH DIVISION parameter specifies the position on the chart corresponding to the top of zone 1 (and the bottom of zone 2 if zone 2 is used). The ZONE 2 HIGH DIVISION parameter specifies the position on the chart corresponding to the top of zone 2, with zero specifying that zone 2 is not used.

The SPAN 1 LOW parameter specifies the value corresponding to the bottom of zone 1 and SPAN 1 HIGH parameter specifies the value corresponding to the top of zone 1 and bottom of zone 2 (if used). The SPAN 2 HIGH parameter specifies the value corresponding to the top of zone 2. If the zone 2 parameter is zero, zone 2 is inactive or not used.

The DIVISION parameters specify location relative to the CHART DIVISIONS parameter (or number of chart rings), which corresponds to the usable recording span of the chart.

The SCALE INTERVAL parameters specify the number of divisions between printed scale values. The values printed are calculated by the instrument. If the SCALE INTERVAL parameter is zero, no scale is printed, but the recorder tag will be printed.

Values corresponding to the bottom of the recordable area are located slightly upscale so that they are printable. Values corresponding to the top of the recordable area are located slightly downscale so that they do not interfere with the time and date. All other values are centered vertically on the corresponding concentric circle.

The UNITS that are configured for display are printed next to the outermost scale value.

The RECORDER TAG for each recorded trend is printed underneath the outermost scale value.

The CHART TAG, time, and date are printed just beyond the recording area, at successive major time lines as follows:

On 10" and 12" Charts:

CHART TAG	TIME	DATE	TIME
-----------	------	------	------

On 11" Charts:

CHART TAG	DATE	CHART TAG	DATE
TIME	TIME	TIME	TIME

The color of the scale line, scale values, units, and recorder tag always correspond to the trend for which they apply.

The color of the major time lines, minor time lines, time, and date/chart tag are each programmable.

### 3.8.1 CHART PRINTING INTERRUPTIONS

When chart printing is interrupted momentarily, the printing resumes as though no interruption had occurred.

If the interruption lasts beyond the point at which data should have been printed, the chart will advance to the appropriate point, printing minor and major time lines as needed, and resume trending.

If the interruption lasts long enough such that no data would be printed between successive major time divisions, the divisions will not be printed.

When power is restored, the chart is marked with an arrow ("↓") to indicate the point of power interruption.

### 3.8.2 NEW CHART PRINTING REQUIREMENTS

The following ACTION ON NEW CHART options are provided:

NONE - JUST CONTINUE  
PRINT RANGE LIST  
PRINT SCALES

The following example illustrates the format used if PRINT RANGE LIST has been configured. This method would be selected to reduce the time between chart installation and initial trend recording. This Range List corresponds to the example found at the end of this section.

<u>Line</u>	<u>Print</u>	<u>Description</u>	<u>Color</u>
1	FLOW #1	Recorder Tag	Black
2	0/400 GPM	Span, Units	Black
3	TEMP #1	Recorder Tag	Blue
4	20/120 *F NL	Span, Units	Blue
5	PH #1	Recorder Tag	Green
6	0/14 PH NL	Span, Units	Green
7	ALARM #1	Recorder Tag	Red
8	0/1 NL	Span, Units	Red

If the scale is other than a simple 0 to 100% of chart with one zone, "NL" will follow the units to indicate non linear.

If PRINT SCALES has been configured, the instrument will proceed to print, as needed per the chart format, time lines, scale lines, scale values, units and recorder tag for each recording pen which is configured. The time, date, and chart tag will not be printed during this process. The chart will be advanced to the correct position for the next time line after the completion of printing for each recording pen.

Upon completion of PRINT RANGE LIST or PRINT SCALES, if configured, the instrument is ready to begin trending. Trending will not begin if the instrument status has been set to OFF or the chart has been stopped.

When the instrument first begins trending after a new chart has been installed, it will print, as needed per the chart format, time lines, scale lines, scale values, units, and recorder tag for each recording pen until it reaches the position corresponding to the current time. **If the instrument status has not been set to off and the chart has not been stopped by other than the chart being full, historical trend data will also be included.** The time, date, and chart tag will be printed during this process. At this point, the instrument will begin the normal recording process and marks the chart on the outer ring with an arrow(" ►") to indicate where the trend began.

### 3.8.3 EXAMPLE CHART

Figure 3-2 (page 3-12) illustrates the typical data presentation for a 12" chart. The "recorder" trends are referred to by number in this illustration for black and white reproduction.

Refer to Table 3-1 (page 3-10) and Table 3-2 (page 3-11) for the corresponding recorder configuration/programming data. For this example, the instrument has four inputs as follows:

- 1 Raw Flow Value
- 2 Temperature
- 3 Pressure
- 4 pH

The value recorded on Pen 1 is a derived value; flow corrected for temperature and pressure. The derived value is also converted to a process value for alarming.

(Continued on next page)





### 3.8.4 SEQUENCE OF EVENTS

- 11:27 PM Chart installed
- 11:30 PM Instrument began printing with the Chart Tag, (UNIT #1) and the trend data collected and saved between 11:27 and 11:30, while continuing to save scanned data. Note the "▶" on the outer ring to indicate where trending began
- 11:31 PM Instrument caught up to the current time and began normal trending.
- 11:50 PM Flow rate went into alarm.
- 12:20 PM Flow rate came out of alarm.
- 12:54 PM Recording interrupted by power failure.
- 1:12 PM Recording restored, "↓" marked on the chart at X:XX PM to indicate point of power interruption and chart positioned to correct time and trending resumes.

**FIGURE 3-2**

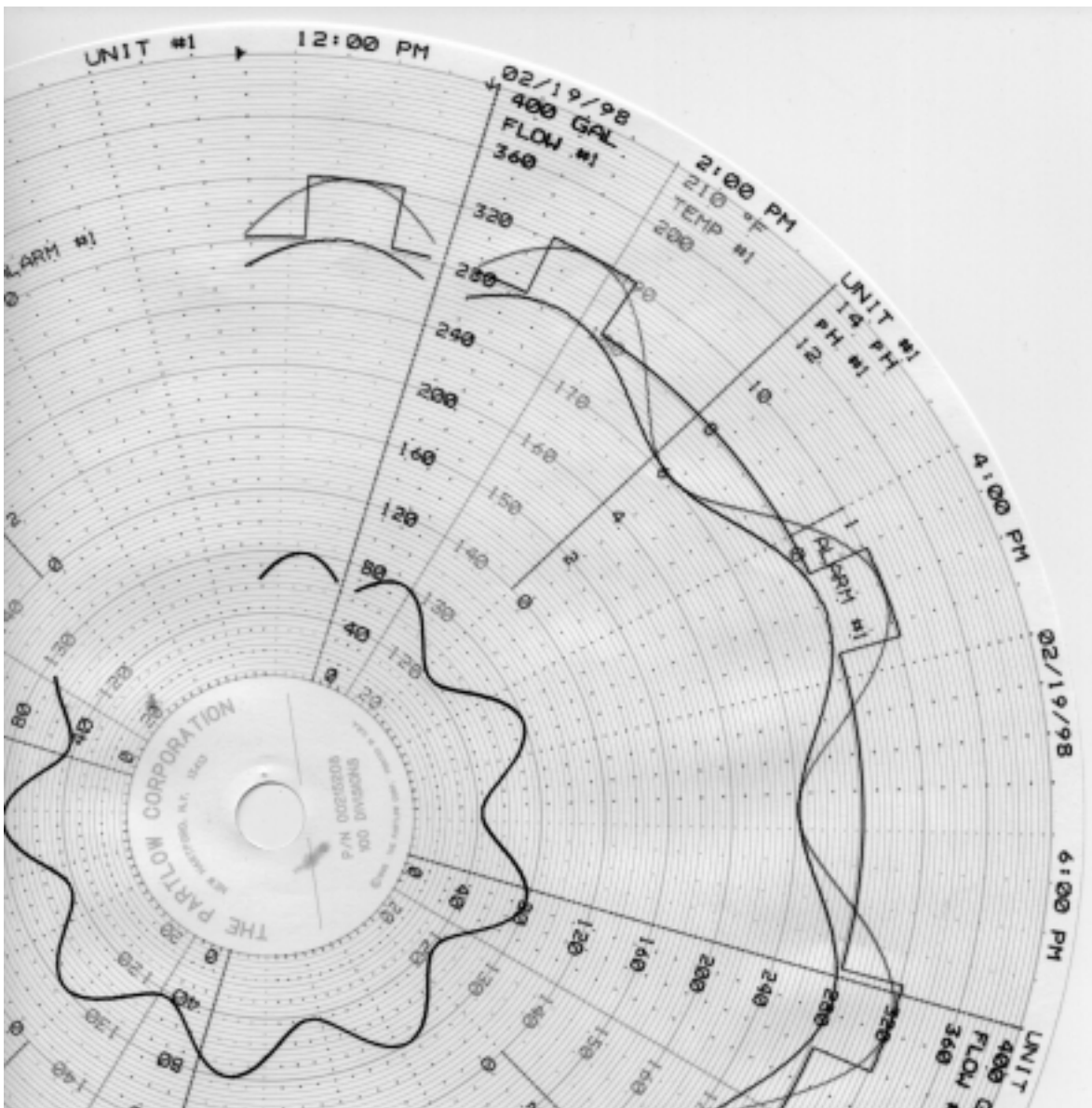



### 3.9 GETTING STARTED

Before attempting any configuration/programming, review Sections 3.3 Keypad Function; 3.4 Changing Parameter Settings; 3.7 Display Details; 3.8 Chart Details; and Appendix C Reference Section.

Then, using the Flow Charts below, the Quick Start Procedure, page 3-14 and filled in the Software Reference/Record Sheets, determine the prompts and parameters that will be required for proper operation of the instrument and begin the configuration and programming procedures as described in Section 4 Configuration; Section 5 Display Programming; Section 6 Chart Prompts, and if required, Section 7 Alarm Settings and Section 8 Action Time Settings. Section 9 contains procedures for Enabling/Disabling and entering Passwords.

Appendix D may be referred to for examples of how to program/configure some prompts and parameters.

#### MAIN PROMPTS

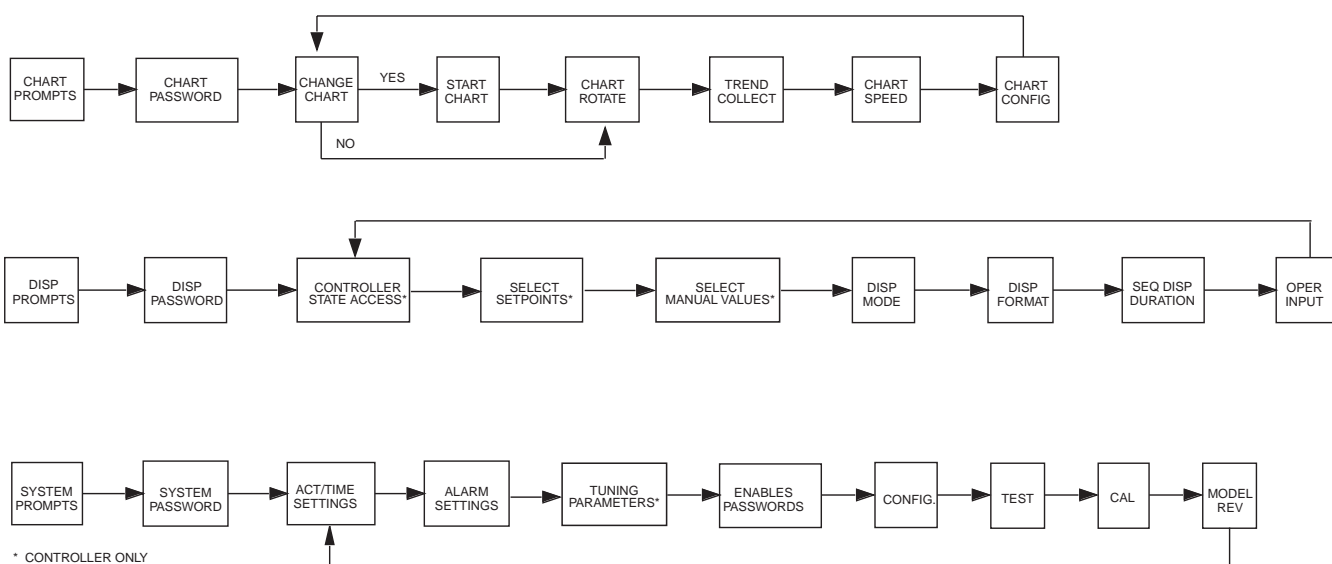

#### CONFIGURATION

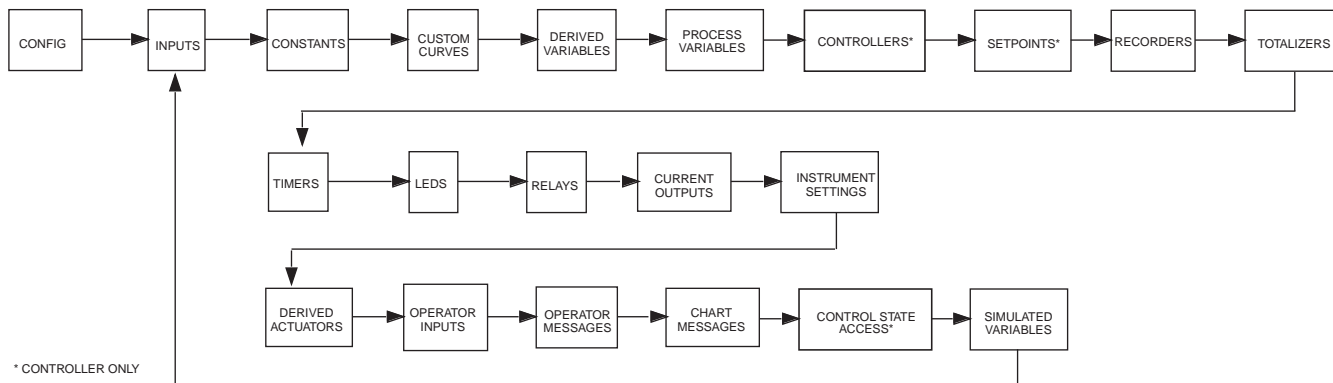

---

### 3.10 QUICK START PROCEDURE

This procedure can be used for starting up the recorder at the very basic level of recording inputs or to quickly familiarize yourself with the basic configuration process. A large number of default parameters are utilized and the default conditions are assumed. Please refer to the balance of Section 4 for important details on how to get full use of the instruments capabilities.

To use this procedure you should have already jumper configured at least one input (see Section 2 - Installation and Wiring), or be willing to use the factory settings of Thermocouple, Wide Span and Upscale Break protection. The marker pen assembly should also be installed, see Section 2 for installation instructions.

Connect a sensor or input signal source to the primary input that matches the type of hardware configured on the input board. If the input is configured as a thermocouple, you can simply install a wire between the input connections and the unit will indicate the temperature inside the instrument.

To perform Quick Start you will need to configure the Input Value, Recorder Pen, Chart, and Display.

#### Input Value Configuration

##### Step 1

From a power-up state, depress the SCROLL key until CONFIGURATION shows in the lower line display (the upper line display will show SELECT). With CONFIGURATION in the lower line display, use the DOWN key, then SCROLL key to select INPUTS. Press the DOWN ARROW key to display INPUT NUMBER. The INPUT NUMBER must agree with the input to be displayed and recorded. Press the MOD key, use the UP/DOWN arrows to change the value, and the ENTER key to make the selection.

##### Step 2

Depress the SCROLL key twice to skip over IVx COPY/INITIALIZE. The display should show IVx DISPLAY TAG. If you wish to enter a Display Tag, use the MOD key and then the UP/DOWN arrows or MOD key again to enter the Character Selection, then select characters for the Tag.

##### Step 3

Depress the SCROLL key to advance to the display, IVx INPUT TYPE/RANGE. The default will be OFF-NO INPUT. Select MOD to change this and SCROLL to select an input type. Press ENTER to finalize the selection.

##### Step 4

The Prompts displayed, after the next depression of the SCROLL key will depend on which Input Type/Range was selected. If Thermocouple or RTD were selected, then the specific type of Thermocouple or RTD will need to be selected. Use the MOD key to change, then the SCROLL and ENTER keys as before. Degrees C or F can also be selected after the type of TC or RTD has been specified by pressing the LEFT ARROW or SCROLL key to choice, then press Enter. If mA, mV, or volt was selected go to step 5, otherwise go to Step 7.

##### Step 5

Press the SCROLL key to INPUT RANGE LOW (default = 0) and INPUT RANGE HIGH (default = 100). These two parameters specify the desired analog signal range (4-20mA, 0-100mV) that will be scaled to engineering units.

##### Step 6

If mA, mV, or VOLT was selected, the SCROLL key will display IVx V/mA CONVERSION next. LINEAR is the default condition. Select according to the type of signal conversion desired.

##### Step 7

The next display will show IVx DISPLAY UNITS. Select F, C or OTHER. If OTHER is selected, the SCROLL key will next bring up IVx OTHER UNITS on the display. Use the MOD key, then UP/DOWN arrows and ENTER to specify the Display Units.

#### Step 8

Next, the display will show IVx DECIMAL POSITION, IVx RANGE LIMIT LOW, and IVx RANGE LIMIT HIGH. These will be used to calculate the engineering units range for volt/milliamp inputs for the Input being configured. For Thermocouple/RTD inputs, their values establish the expected range outside of which the instrument will consider the value "out of range". Select accordingly with the MOD, SCROLL, UP/DOWN arrows and ENTER.

#### Step 9

Depress the SCROLL key and skip over the rest of the Input Selections until the display shows IVx DISPLAY OPTION. Select IN BOTH MODES for this input.

#### Step 10

After depressing the ENTER key, depress the UP ARROW key to get back to the previous level of CONFIGURE.

#### Step 11

Depress the SCROLL key until RECORDERS is displayed in the lower line display.

#### Step 12

Depress the DOWN ARROW key to enter the Recorder Configuration section. Depress the SCROLL key and skip over the displays shown until the display shows Rx VALUE TO RECORD. Use the MOD and UP/DOWN keys to select IVx where X is the input channel being configured. Press ENTER to finalize this selection.

#### Step 13

Depress the SCROLL key and skip over the displays until the display shows Rx SPAN 1 LOW and enter the low end of the range of units to be recorded. In other words, what input value (in units) should represent the low end of chart. Input this value using the MOD, UP/DOWN arrows, SCROLL and ENTER as before.

#### Step 14

Repeat for Rx SPAN 1 HIGH, using the input value (in units) that should represent the high end of the chart.

Note: the recorder span should normally correspond to an even multiple of one hundred units (for example 0 to 200 or 30 to 130, not 0 to 130) so the scales are convenient to read.

#### Step 15

Depress the UP ARROW key 3 times to return to the Normal Display.

#### Step 16

Depress the CHART key until SELECT and CHART CONFIGURATION appears. Press the DOWN ARROW key to show CHART SIZE. Select the chart size being used. Press the UP ARROW key twice to return to the Normal Display.

#### Step 17

Depress the CHART key again until CHANGE CHART appears. Select YES. Install the chart. Be sure to adjust the three retaining clips according to the size chart being used. The display should show START NEW CHART. Select YES with the LEFT ARROW key and then press ENTER.

After initializing the chart, the recorder should begin recording and displaying values for the Input Signal just configured.

# Software Reference/Record Sheet

## Configuration INPUT

Parameter	Input 1	Input 2	Input 3	Input 4
DISPLAY TAG				
INPUT TYPE/RANGE				
T/C TYPE				
RTD TYPE				
DEG C/F				
SENSOR BREAK	Upscale Downscale	Upscale Downscale	Upscale Downscale	Upscale Downscale
INPUT RANGE LOW				
INPUT RANGE HIGH				
PULSE RATE HIGH	Pulse/Sec	Pulse/Sec	Pulse/Sec	Pulse/Sec
COMMS ADDRESS				
COMMS REGISTER				
REGISTER TYPE				
V/MA CONVERSION				
DISPLAY UNITS				
OTHER UNITS				
DECIMAL POSITION				
RANGE LIMIT LOW	Units	Units	Units	Units
RANGE LIMIT HIGH	Units	Units	Units	Units
EXPONENT				
CUTOFF TYPE				
CUTOFF VALUE				
INPUT CORRECT 1	@	@	@	@
INPUT CORRECT 2	@	@	@	@
VALUE FILTER	Seconds	Seconds	Seconds	Seconds
DISPLAY OPTION				
OPEN/1 DESCR.				
CLOSED/0 DESCR.				
DISPLAY FILTER	Seconds	Seconds	Seconds	Seconds

# Software Reference/Record Sheet

## Configuration

### INPUT

Parameter	Input 5		Input 6		Input 7		Input 8	
DISPLAY TAG								
INPUT TYPE/RANGE								
T/C TYPE								
T/C INPUT SPAN	Wide	Narrow	Wide	Narrow	Wide	Narrow	Wide	Narrow
RTD TYPE								
DEG C/F								
V/MA INPUT TYPE								
SENSOR BREAK	Upscale	Downscale	Upscale	Downscale	Upscale	Downscale	Upscale	Downscale
INPUT RANGE LOW								
INPUT RANGE HIGH								
PULSE RATE HIGH		Pulse/Sec		Pulse/Sec		Pulse/Sec		Pulse/Sec
COMMS ADDRESS								
COMMS REGISTER								
REGISTER TYPE								
V/MA CONVERSION								
DISPLAY UNITS								
OTHER UNITS								
DECIMAL POSITION								
RANGE LIMIT LOW		Units		Units		Units		Units
RANGE LIMIT HIGH		Units		Units		Units		Units
EXPONENT								
CUTOFF TYPE								
CUTOFF VALUE								
INPUT CORRECT 1		@		@		@		@
INPUT CORRECT 2		@		@		@		@
VALUE FILTER		Seconds		Seconds		Seconds		Seconds
DISPLAY OPTION								
HIGH STATE DES								
LOW STATE DES								
DISPLAY FILTER		Seconds		Seconds		Seconds		Seconds

# Software Reference/Record Sheet

## Configuration CONSTANTS

Parameter	CV-1	CV-2	CV-3	CV-4
VALUE				

Parameter	CV-5	CV-6	CV-7	CV-8
VALUE				

Parameter	CV-9	CV-10	CV-11	CV-12
VALUE				

# Software Reference/Record Sheet

## Configuration CUSTOM CURVES

Parameter	CC-1	CC-2
DECIMAL POSITION OF INPUT		
DECIMAL POSITION OF OUTPUT		
NUMBER OF POINTS		
POINT PAIR 01	-->	-->
POINT PAIR 02	-->	-->
POINT PAIR 03	-->	-->
POINT PAIR 04	-->	-->
POINT PAIR 05	-->	-->
POINT PAIR 06	-->	-->
POINT PAIR 07	-->	-->
POINT PAIR 08	-->	-->
POINT PAIR 09	-->	-->
POINT PAIR 10	-->	-->
POINT PAIR 11	-->	-->
POINT PAIR 12	-->	-->
POINT PAIR 13	-->	-->
POINT PAIR 14	-->	-->
POINT PAIR 15	-->	-->
POINT PAIR 16	-->	-->
POINT PAIR 17	-->	-->
POINT PAIR 18	-->	-->
POINT PAIR 19	-->	-->
POINT PAIR 20	-->	-->
POINT PAIR 21	-->	-->

# Software Reference/Record Sheet

## Configuration CUSTOM CURVES

Parameter	CC-3	CC-4
DECIMAL POSITION OF INPUT		
DECIMAL POSITION OF OUTPUT		
NUMBER OF POINTS		
POINT PAIR 01	-->	-->
POINT PAIR 02	-->	-->
POINT PAIR 03	-->	-->
POINT PAIR 04	-->	-->
POINT PAIR 05	-->	-->
POINT PAIR 06	-->	-->
POINT PAIR 07	-->	-->
POINT PAIR 08	-->	-->
POINT PAIR 09	-->	-->
POINT PAIR 10	-->	-->
POINT PAIR 11	-->	-->
POINT PAIR 12	-->	-->
POINT PAIR 13	-->	-->
POINT PAIR 14	-->	-->
POINT PAIR 15	-->	-->
POINT PAIR 16	-->	-->
POINT PAIR 17	-->	-->
POINT PAIR 18	-->	-->
POINT PAIR 19	-->	-->
POINT PAIR 20	-->	-->
POINT PAIR 21	-->	-->



# Software Reference/Record Sheet

## Configuration DERIVED VARIABLES

Parameter	DV-1	DV-2	DV-3	DV-4
DISPLAY TAG				
FUNCTION				
INPUT 1				
INPUT 2				
INPUT 3				
INPUT 4				
INPUT 5				
INPUT ACTUATOR				
RESET ACTUATOR				
DISPLAY UNITS				
UNITS DESCRIPTION				
DECIMAL POSITION				
VALUE FILTER	seconds	seconds	seconds	seconds
DISPLAY OPTION				
DISPLAY FILTER	seconds	seconds	seconds	seconds

Parameter	DV-5	DV-6	DV-7	DV-8
DISPLAY TAG				
FUNCTION				
INPUT 1				
INPUT 2				
INPUT 3				
INPUT 4				
INPUT 5				
INPUT ACTUATOR				
RESET ACTUATOR				
DISPLAY UNITS				
UNITS DESCRIPTION				
DECIMAL POSITION				
VALUE FILTER	seconds	seconds	seconds	seconds
DISPLAY OPTION				
DISPLAY FILTER	seconds	seconds	seconds	seconds

# Software Reference/Record Sheet

## Configuration DERIVED VARIABLES

Parameter	DV-9	DV-10	DV-11	DV-12
DISPLAY TAG				
FUNCTION				
INPUT 1				
INPUT 2				
INPUT 3				
INPUT 4				
INPUT 5				
INPUT ACTUATOR				
RESET ACTUATOR				
DISPLAY UNITS				
UNITS DESCRIPTION				
DECIMAL POSITION				
VALUE FILTER	seconds	seconds	seconds	seconds
DISPLAY VALUE				
DISPLAY FILTER	seconds	seconds	seconds	seconds

# Software Reference/Record Sheet

## Configuration PROCESS VARIABLES

Parameter	PV-1	PV-2	PV-3	PV-4
DISPLAY TAG				
INPUT				
DISPLAY UNITS				
OTHER UNITS				
DECIMAL POSITION				
VALUE FILTER	seconds	seconds	seconds	seconds
DISPLAY OPTION				
DISPLAY FILTER	seconds	seconds	seconds	seconds
Ax1 ALARM TYPE				
Ax1 TIME BASE				
Ax1 SAMPLE PERIOD	seconds	seconds	seconds	seconds
Ax1 HYSTERESIS				
Ax2 ALARM TYPE				
Ax2 TIME BASE				
Ax2 SAMPLE PERIOD	seconds	seconds	seconds	seconds
Ax2 HYSTERESIS				
Ax3 ALARM TYPE				
Ax3 TIME BASE				
Ax3 SAMPLE PERIOD	seconds	seconds	seconds	seconds
Ax3 HYSTERESIS				
Ax4 ALARM TYPE				
Ax4 TIME BASE				
Ax4 SAMPLE PERIOD	seconds	seconds	seconds	seconds
Ax4 HYSTERESIS				
LOOP ALARM TIME				
ALARM INHIBIT				

# Software Reference/Record Sheet

## Configuration CONTROLLERS

Parameter	CONTROLLER-1		CONTROLLER-2		CONTROLLER-3		CONTROLLER-4	
CONTROL TYPE								
OUT 1 TYPE								
OUT 2 TYPE								
OUT 1 HYST								
OUT 2 HYST								
OUT 1 % LIMIT		%		%		%		%
OUT 2 % LIMIT		%		%		%		%
OUT 1 % ERROR		%		%		%		%
OUT 2 % ERROR		%		%		%		%
OUT SLEW RATE		%/MIN		%/MIN		%/MIN		%/MIN
MANUAL ACTUATOR								
AUTO TRANSFER	OFF	ON	OFF	ON	OFF	ON	OFF	ON
MAIN SP SOURCE								
REMOTE SP ACTUATOR								
REMOTE SP SOURCE								
2nd SP ACTUATOR								
2nd SP SOURCE								
REMOTE SP RATIO								
REMOTE SP BIAS								
FEED FWD SOURCE								
FEED FWD HIGH								
FEED FWD LOW								
DISP SELECT SP								
DISP RAMPED SP								
DISP % OUTPUTS								

# Software Reference/Record Sheet

## Configuration CONTROL SETPOINTS

Parameter	Setpoint 1	Setpoint 2	Setpoint 3	Setpoint 4
*PROMPT TEXT				
DISPLAY UNITS				
OTHER UNITS				
DEC POSITION				
UPPER LIMIT				
LOWER LIMIT				
DISP OPTION				

Parameter	Setpoint 1	Setpoint 2	Setpoint 3	Setpoint 4
*PROMPT TEXT				
DISPLAY UNITS				
OTHER UNITS				
DEC POSITION				
UPPER LIMIT				
LOWER LIMIT				
DISP OPTION				

\* If the prompt text is blank, the setpoint is disabled and the remaining prompts will not be seen. The setpoint will also not appear in the setpoint sub-menu of the DISPLAY menu.

# Software Reference/Record Sheet

## Configuration RECORDERS

Parameter	RCDR-1	RCDR-2	RCDR-3	RCDR-4
RECORDER TAG				
VALUE TO RECORD				
PEN/COLOR				
RECORDING METHOD				
DECIMAL POSITION				
CHART DIVISIONS				
ZONE 1 LOW	division	division	division	division
ZONE 1 HIGH	division	division	division	division
SPAN 1 LOW				
SPAN 1 HIGH				
SCALE 1 INTERVAL	divisions	divisions	divisions	divisions
ZONE 2 HIGH	division	division	division	division
SPAN 2 HIGH				
SCALE 2 INTERVAL	divisions	divisions	divisions	divisions
POSIT ON ERROR	division	division	division	division
FILTER	seconds	seconds	seconds	seconds

# Software Reference/Record Sheet

## Configuration TOTALIZERS

Parameter	TOTAL-1	TOTAL-2	TOTAL-3	TOTAL-4
DISPLAY TAG				
INPUT VALUE				
TIME BASE				
TOTAL IS FLOW	times	times	times	times
DISPLAY UNITS				
DECIMAL POSITION				
DISPLAY OPTION				
DISPLAY FORMAT				
TOTALIZER TYPE				
TOTALIZER PRESET				
LOW FLOW CUTOFF				
RESET ACTUATOR				
HOLD ACTUATOR				
PULSED OUT	no    yes	no    yes	no    yes	no    yes
PULSE EVERY				

# Software Reference/Record Sheet

## Configuration TIMERS

Parameter	TIME-1	TIME-2	TIME-3	TIME-4
DISPLAY TAG				
TIMER TYPE				
TIME FORMAT				
TIMER PERIOD				
RESET ACTUATOR				
DISPLAY OPTION				

## Configuration LEDS

Parameter	LED-1	LED-2	LED-3	LED-4
ACTUATOR				

Parameter	LED-5	LED-6	LED-7	LED-8
ACTUATOR				



# Software Reference/Record Sheet

## Configuration

### RELAYS

Parameter	RLY-1	RLY-2	RLY-3	RLY-4
RELAY USAGE				
ACTUATOR				
T.P. VALUE				
CYCLE TIME	seconds	seconds	seconds	seconds

Parameter	RLY-5	RLY-6	RLY-7	RLY-8
RELAY USAGE				
ACTUATOR				
T.P. VALUE				
CYCLE TIME	seconds	seconds	seconds	seconds

# Software Reference/Record Sheet

## Configuration CURRENT OUTPUTS

Parameter	CO-1	CO-2	CO-3	CO-4
SOURCE				
RANGE LOW				
RANGE HIGH				
OUTPUT RANGE	mA	mA	mA	mA
OUTPUT ON ERROR	mA	mA	mA	mA

# Software Reference/Record Sheet

## Configuration

### INSTRUMENT SETTINGS

Parameter	
INSTRUMENT TAG	
DISPLAY OPTION	
INSTR. ON ACTUATOR	
ALARMING ON ACTUATOR	
CONTROL ON ACTUATOR	
DATE DISPLAY FORMAT	
TIME DISPLAY FORMAT	
CURRENT DATE	
CURRENT DAY	
CURRENT TIME	
TIME TO LOG DATA	
COMMUNICATIONS MODE	
COMMS ADDRESS	
COMMS BIT RATE	
COMMS PARITY	
INPUT SCAN SEQUENCE	

# Software Reference/Record Sheet

## Configuration DERIVED ACTUATORS

Derived Actuator	Equation
DA-1	
DA-2	
DA-3	
DA-4	
DA-5	
DA-6	
DA-7	
DA-8	
DA-9	
DA-10	
DA-11	
DA-12	
DA-13	
DA-14	
DA-15	
DA-16	
DA-17	
DA-18	
DA-19	
DA-20	
DA-21	
DA-22	
DA-23	
DA-24	

# Software Reference/Record Sheet

## Configuration OPERATOR INPUTS

Parameter	OI-01			OI-02			OI-03		
PROMPT TEXT									
OFF/NO/0 CHOICE									
ON/YES/1 CHOICE									
ACTUATION STYLE	Continuous	Momentary		Continuous	Momentary		Continuous	Momentary	
POWER UP STATE	Off	On	Same	Off	On	Same	Off	On	Same
WHEN DISPLAYED	Always	When	Enabled	Always	When	Enabled	Always	When	Enabled

Parameter	OI-04			OI-05			OI-06		
PROMPT TEXT									
OFF/NO/0 CHOICE									
ON/YES/1 CHOICE									
ACTUATION STYLE	Continuous	Momentary		Continuous	Momentary		Continuous	Momentary	
POWER UP STATE	Off	On	Same	Off	On	Same	Off	On	Same
WHEN DISPLAYED	Always	When	Enabled	Always	When	Enabled	Always	When	Enabled

Parameter	OI-07			OI-08			OI-09		
PROMPT TEXT									
OFF/NO/0 CHOICE									
ON/YES/1 CHOICE									
ACTUATION STYLE	Continuous	Momentary		Continuous	Momentary		Continuous	Momentary	
POWER UP STATE	Off	On	Same	Off	On	Same	Off	On	Same
WHEN DISPLAYED	Always	When	Enabled	Always	When	Enabled	Always	When	Enabled

Parameter	OI-10			OI-11			OI-12		
PROMPT TEXT									
OFF/NO/0 CHOICE									
ON/YES/1 CHOICE									
ACTUATION STYLE	Continuous	Momentary		Continuous	Momentary		Continuous	Momentary	
POWER UP STATE	Off	On	Same	Off	On	Same	Off	On	Same
WHEN DISPLAYED	Always	When	Enabled	Always	When	Enabled	Always	When	Enabled

# Software Reference/Record Sheet

## Configuration OPERATOR MESSAGES

Parameter	OM-01	OM-02	OM-03
ACTUATOR			
LINE 1 TEXT			
LINE 2 TEXT			
DISPLAY MODE			

Parameter	OM-04	OM-05	OM-06
ACTUATOR			
LINE 1 TEXT			
LINE 2 TEXT			
DISPLAY MODE			

Parameter	OM-07	OM-08	OM-09
ACTUATOR			
LINE 1 TEXT			
LINE 2 TEXT			
DISPLAY MODE			

Parameter	OM-10	OM-11	OM-12
ACTUATOR			
LINE 1 TEXT			
LINE 2 TEXT			
DISPLAY MODE			

# Software Reference/Record Sheet

## Configuration CHART MESSAGES

Parameter	CM-01	CM-02	CM-03	CM-04
ACTUATOR				
PEN/COLOR				
MESSAGE TEXT				
VALUE 1				
VALUE 2				
VALUE 3				
VALUE 4				
TIME/DATE STAMP	No Yes	No Yes	No Yes	No Yes
ORIENTATION				

Parameter	CM-05	CM-06	CM-07	CM-08
ACTUATOR				
PEN/COLOR				
MESSAGE TEXT				
VALUE 1				
VALUE 2				
VALUE 3				
VALUE 4				
TIME/DATE STAMP	No Yes	No Yes	No Yes	No Yes
ORIENTATION				

Parameter	CM-09	CM-10	CM-11	CM-12
ACTUATOR				
PEN/COLOR				
MESSAGE TEXT				
VALUE 1				
VALUE 2				
VALUE 3				
VALUE 4				
TIME/DATE STAMP	No Yes	No Yes	No Yes	No Yes
ORIENTATION				

# Software Reference/Record Sheet

## Configuration CONTROL STATE ACCESS

Parameter	Text
CA1 LINE 1 TEXT	
CA1 LINE 2 TEXT	
CA1 F1 KEY USAGE	
CA1 F1 LINE 1 TEXT	
CA1 F1 OFF STATE TEXT	
CA1 F1 ON STATE TEXT	
CA1 F2 KEY USAGE	
CA1 F2 LINE 1 TEXT	
CA1 F2 OFF STATE TEXT	
CA1 F2 ON STATE TEXT	
CA1 F3 KEY USAGE	
CA1 F3 LINE 1 TEXT	
CA1 F3 OFF STATE TEXT	
CA1 F3 ON STATE TEXT	
CA1 F4 KEY USAGE	
CA1 F4 LINE 1 TEXT	
CA1 F4 OFF STATE TEXT	
CA1 F4 ON STATE TEXT	
CA1 F5 KEY USAGE	
CA1 F5 LINE 1 TEXT	
CA1 F5 OFF STATE TEXT	
CA1 F5 ON STATE TEXT	



# Software Reference/Record Sheet

## Configuration CONTROL STATE ACCESS

Parameter	Text
CA2 LINE 1 TEXT	
CA2 LINE 2 TEXT	
CA2 F1 KEY USAGE	
CA2 F1 LINE 1 TEXT	
CA2 F1 OFF STATE TEXT	
CA2 F1 ON STATE TEXT	
CA2 F2 KEY USAGE	
CA2 F2 LINE 1 TEXT	
CA2 F2 OFF STATE TEXT	
CA2 F2 ON STATE TEXT	
CA2 F3 KEY USAGE	
CA2 F3 LINE 1 TEXT	
CA2 F3 OFF STATE TEXT	
CA2 F3 ON STATE TEXT	
CA2 F4 KEY USAGE	
CA2 F4 LINE 1 TEXT	
CA2 F4 OFF STATE TEXT	
CA2 F4 ON STATE TEXT	
CA2 F5 KEY USAGE	
CA2 F5 LINE 1 TEXT	
CA2 F5 OFF STATE TEXT	
CA2 F5 ON STATE TEXT	

# Software Reference/Record Sheet

## Configuration CONTROL STATE ACCESS

Parameter	Text
CA3 LINE 1 TEXT	
CA3 LINE 2 TEXT	
CA3 F1 KEY USAGE	
CA3 F1 LINE 1 TEXT	
CA3 F1 OFF STATE TEXT	
CA3 F1 ON STATE TEXT	
CA3 F2 KEY USAGE	
CA3 F2 LINE 1 TEXT	
CA3 F2 OFF STATE TEXT	
CA3 F2 ON STATE TEXT	
CA3 F3 KEY USAGE	
CA3 F3 LINE 1 TEXT	
CA3 F3 OFF STATE TEXT	
CA3 F3 ON STATE TEXT	
CA3 F4 KEY USAGE	
CA3 F4 LINE 1 TEXT	
CA3 F4 OFF STATE TEXT	
CA3 F4 ON STATE TEXT	
CA3 F5 KEY USAGE	
CA3 F5 LINE 1 TEXT	
CA3 F5 OFF STATE TEXT	
CA3 F5 ON STATE TEXT	

# Software Reference/Record Sheet

## Configuration CONTROL STATE ACCESS

Parameter	Text
CA4 LINE 1 TEXT	
CA4 LINE 2 TEXT	
CA4 F1 KEY USAGE	
CA4 F1 LINE 1 TEXT	
CA4 F1 OFF STATE TEXT	
CA4 F1 ON STATE TEXT	
CA4 F2 KEY USAGE	
CA4 F2 LINE 1 TEXT	
CA4 F2 OFF STATE TEXT	
CA4 F2 ON STATE TEXT	
CA4 F3 KEY USAGE	
CA4 F3 LINE 1 TEXT	
CA4 F3 OFF STATE TEXT	
CA4 F3 ON STATE TEXT	
CA4 F4 KEY USAGE	
CA4 F4 LINE 1 TEXT	
CA4 F4 OFF STATE TEXT	
CA4 F4 ON STATE TEXT	
CA4 F5 KEY USAGE	
CA4 F5 LINE 1 TEXT	
CA4 F5 OFF STATE TEXT	
CA4 F5 ON STATE TEXT	

# Software Reference/Record Sheet

## Configuration

### SIMULATED VARIABLES

Parameter	SV-1	SV-2	SV-3	SV-4
DISPLAY TAG				
TYPE				
DISPLAY UNITS	C F Other	C F Other	C F Other	C F Other
OTHER UNITS				
DECIMAL POSITION				
RANGE LOW				
RANGE HIGH				
PERIOD (1/FREQ.)	minutes	minutes	minutes	minutes
DISPLAY OPTION				

# Software Reference/Record Sheet

## Configuration CHART PROGRAMMING

Select Chart Configuration					
CHART SIZE					
CHART TYPE USED					
CHART TAG					
NORMAL SPEED					
MAJOR TIME PERIODS					
MINOR TIME PERIODS					
BLANK MAJOR PERIODS					
ALTERNATE SPEED USED					
ALT SPEED ACTUATOR					
ALTERNATE SPEED					
MAJOR TIME PERIODS					
MINOR TIME PERIODS					
BLANK MAJOR PERIODS					
MAJOR LINE PEN/COLOR	MATCH SCALE COLOR			SELECT A COLOR	
MAJOR LINE PEN/COLOR (IF SELECT)	BLUE	GREEN	RED	BLACK	VIOLET
MINOR LINE PEN/COLOR	MATCH SCALE COLOR			SELECT A COLOR	
MINOR LINE PEN/COLOR (IF SELECT)	BLUE	GREEN	RED	BLACK	VIOLET
TIME PEN/COLOR	BLUE	GREEN	RED	BLACK	VIOLET
DATE/PEN COLOR	BLUE	GREEN	RED	BLACK	VIOLET
CHART TAG PEN/COLOR	BLUE	GREEN	RED	BLACK	VIOLET
ACTION ON NEW CHART					
STOP AFTER 1 REVOLUTION					
ROTATE CHART ACTUATOR					
COLLECT DATA ACTUATOR					
CHART ROTATION PROMPT					
TREND DATA COLLECT PROMPT					
CHART SPEED PROMPT					

# Software Reference/Record Sheet

## Configuration

### DISPLAY PROGRAMMING

Parameter			
SEQUENTIAL DISPLAY	DURATION _____	SECONDS	
DISPLAY MODE	CONTINUOUS	SEQUENCE	
DISPLAY FORMAT	1 VAL	2 VALS	4 VALS

# Software Reference/Record Sheet

## Configuration ALARM SETTINGS

<b>PV 1</b>	<b>ALM 1 (A11)</b>	<b>ALM 2 (A12)</b>	<b>ALM 3 (A13)</b>	<b>ALM 4 (A14)</b>
SETPOINT				

<b>PV 2</b>	<b>ALM 1 (A21)</b>	<b>ALM 2 (A22)</b>	<b>ALM 3 (A23)</b>	<b>ALM 4 (A24)</b>
SETPOINT				

<b>PV 3</b>	<b>ALM 1 (A31)</b>	<b>ALM 2 (A32)</b>	<b>ALM 3 (A33)</b>	<b>ALM 4 (A34)</b>
SETPOINT				

<b>PV 4</b>	<b>ALM 1 (A41)</b>	<b>ALM 2 (A42)</b>	<b>ALM 3 (A43)</b>	<b>ALM 4 (A44)</b>
SETPOINT				

# Software Reference/Record Sheet

## Configuration

### ACTION TIME SETTINGS

Parameter	
TIME 1 TAG	
TIME 1	
DATE 1	
TIME 2 TAG	
TIME 2	
DATE 2	
DAY OF WEEK ACTUATOR	
DAY OF MONTH ACTUATOR	
TIME DISPLAY OPTION	



# Software Reference/Record Sheet

## Configuration

### TUNING PARAMETERS

Parameter	CONTROLLER-1	CONTROLLER-2	CONTROLLER-3	CONTROLLER-4
SP RAMP RATE	/HR	/HR	/HR	/HR
OUT 1 P. BAND				
OUT 2 P. BAND				
OUT 1 SHIFT				
OUT 2 SHIFT				
INTEGRATION BAND				
INTEGRATION SHIFT				
OUT 1 AUTO RESET	R/M	R/M	R/M	R/M
OUT 2 AUTO RESET	R/M	R/M	R/M	R/M
OUT 1 RATE	MIN	MIN	MIN	MIN
OUT 2 RATE	MIN	MIN	MIN	MIN

# Software Reference/Record Sheet

## Configuration ENABLES & PASSWORDS

Circle your selected choice  
Factory setting is underlined

Parameter	
ACTION TIME SETTINGS	<u>Disabled</u> - Enabled
ALARM SETTINGS	Disabled - <u>Enabled</u>
TUNING PARAMETERS	Disabled - <u>Enabled</u>
SET POINT CHANGES	Disabled - <u>Enabled</u>
CONFIGURATION	Disabled - <u>Enabled</u>
DERIVED ACTUATORS	Disabled - <u>Enabled</u>
OPERATOR INPUTS CONF	Disabled - <u>Enabled</u>
OPERATOR MESSAGES	Disabled - <u>Enabled</u>
CHART MESSAGES	<u>Disabled</u> - Enabled
SIMULATED VARIABLES	<u>Disabled</u> - Enabled
TEST	Disabled - <u>Enabled</u>
CALIBRATION	Disabled - <u>Enabled</u>
CHART PROMPTS	Disabled - <u>Enabled</u>
CHART CONFIGURATION	<u>Disabled</u> - Enabled
DISPLAY PROMPTS	Disabled - <u>Enabled</u>
OPERATOR INPUTS	Disabled - <u>Enabled</u>
CONTROL STATE ACCESS	Disabled - <u>Enabled</u>
SYSTEM PROMPTS PASSWORD	
ENABLES & PASSWORDS PASSWORD	
CHART PROMPTS PASSWORD	
DISPLAY PROMPTS PASSWORD	

## Section 4 - Configuration

Selections made in Configuration set up the recorder for operation. Not all sections are applicable for every recorder. Before or during configuration of your recorder, it is recommended that the Software Reference/Record Sheet (found at end of Section 3) be completely filled in.

### 4.1 ENTERING CONFIGURATION

From the Normal Display, press the  until **CONFIGURATION** is seen in the lower display line. If **PASS-WORD** appears in the lower display line, the correct "password" will need to be entered before access to **CONFIGURATION** is allowed. If **CONFIGURATION** is not displayed, then Configuration has been disabled. Refer to Section 9, Enables and Passwords, for instructions to enable Configuration.





#### 4.1.1 INPUTS

Input defines input types, ranges, units, scaling and display status for each of 1-8 inputs.

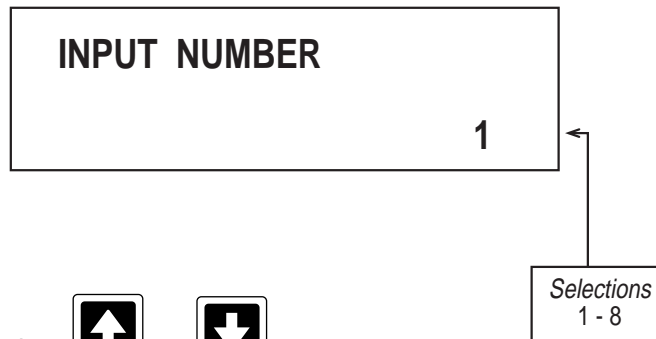
With **CONFIGURATION** in the lower display line, press the  then  until **INPUTS** appears in the lower display line.

1. Press the  to display **INPUT NUMBER**.



Press the  to change, then  or  to desired input number, then press the  to store into memory.

2. Press the  to advance to the next parameter, **COPY/INITIALIZE**.

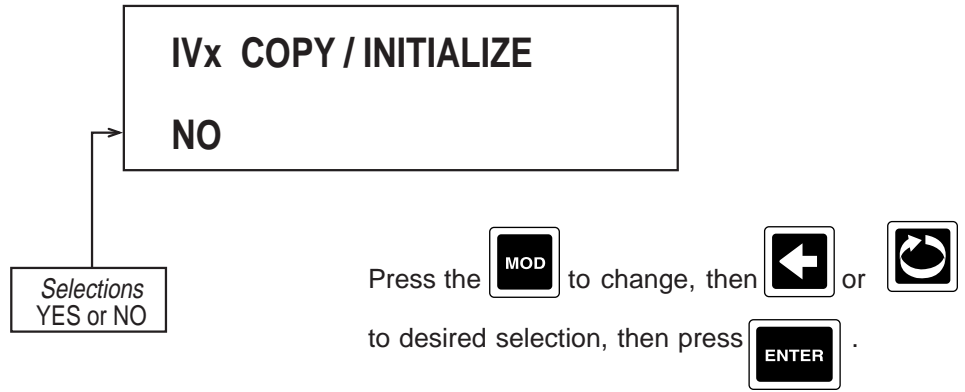



Choose YES if the parameters to be programmed are the same as another INPUT already programmed.

If selection is NO, see Step 3.

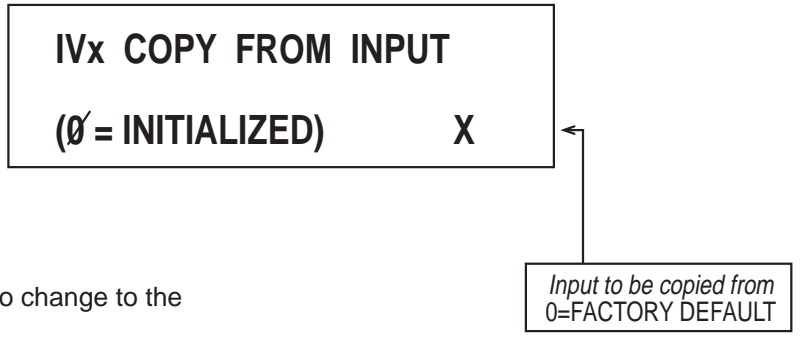
If selection is YES:



Press the  or  to change to the input number to be copied from.

3. Press the  to advance to the next parameter, **DISPLAY TAG**.

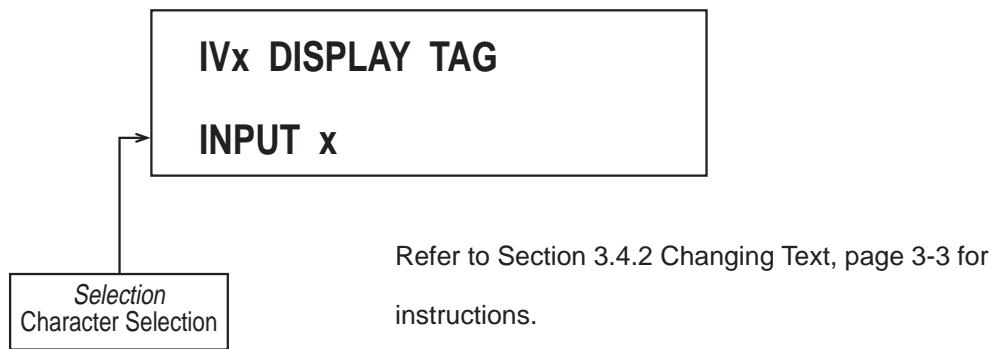

4. Press the  to advance to the next parameter, **INPUT TYPE/RANGE**.

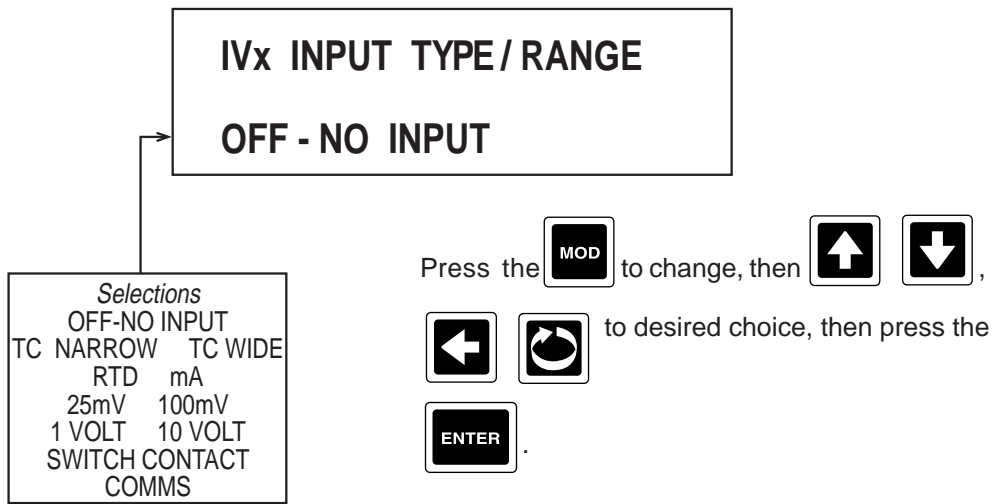

5. Press the  to advance to the next parameter:

OFF-NO INPUT selected, no other prompts for Input x will be seen, go to Step 1, Pg. 4-1.  
**TC TYPE** selected, go to Step 5A.  
**RTD TYPE** selected, go to Step 5B  
**mV, mA, Volt, Switch Contact** go to Step 6.  
**COMMS**, go to Step 6.

5A.

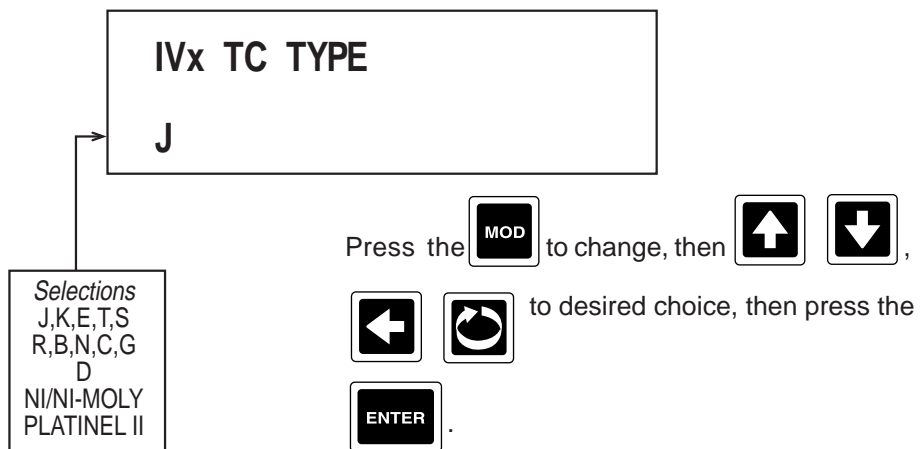

Press the  to advance to step 5C.

5B.

**I  
N  
P  
U  
T  
S**

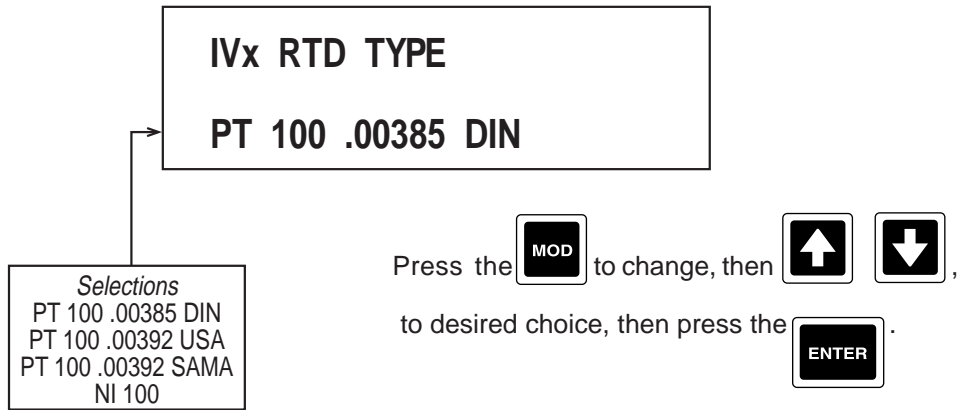

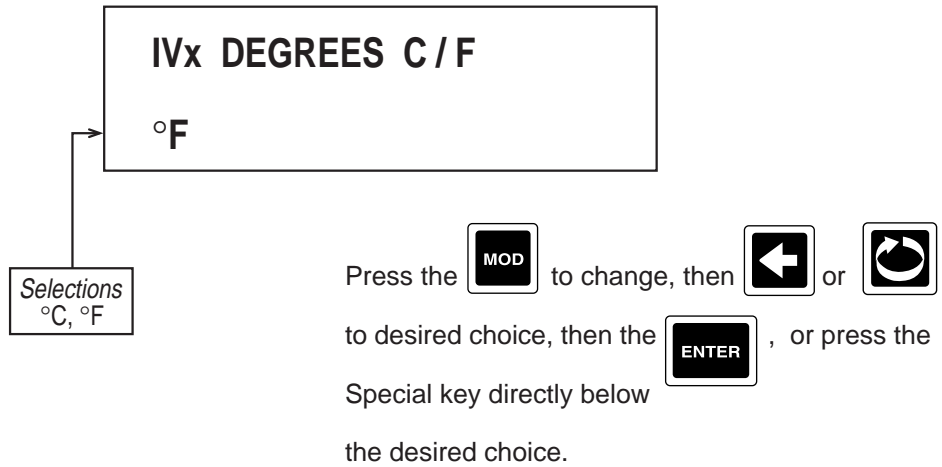

Press the  to advance to step 5C.

5C. If TC or RTD was selected, then press the  to advance to the next parameter, **DEGREES C/F**.

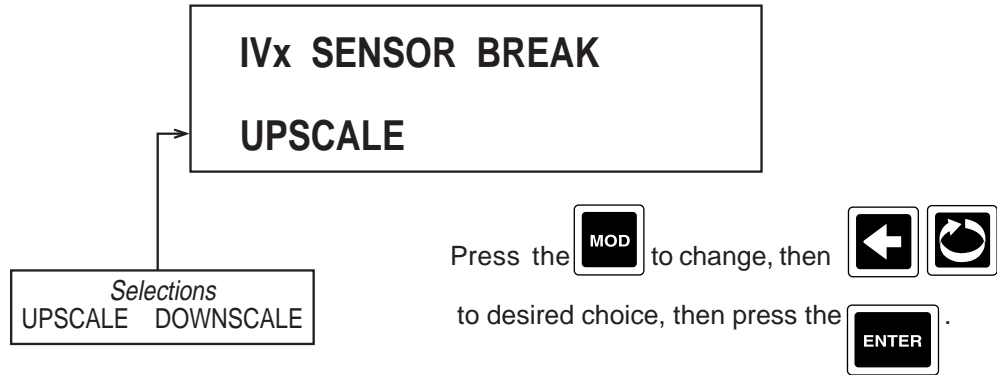

6. Press the  to advance to the next parameter, **SENSOR BREAK**.



Press the  to advance through the next six prompts.

They are six jumper position prompts, non-changeable, and are displayed for information /verification only. The jumper positions are based upon whether the input number is odd/even, input type, and span. Refer to Section 2.3.2 through 2.3.6.

- FOR INPUT NUMBER 1, 3, 5, 7
- JU7 position
  - JU3 position
  - JU1 position
  - JU15 position
  - JU11 position
  - JU2 position

- FOR INPUT NUMBER 2, 4, 6, 8
- JU8 position
  - JU6 position
  - JU4 position
  - JU16 position
  - JU12 position
  - JU5 position

7. If **INPUT TYPE/RANGE** selected was mA, mV, or VOLT, press the  to advance to the next parameter, **INPUT RANGE LOW**.



Units correspond to units configured in INPUT TYPE/RANGE, mA, mV or VOLT.

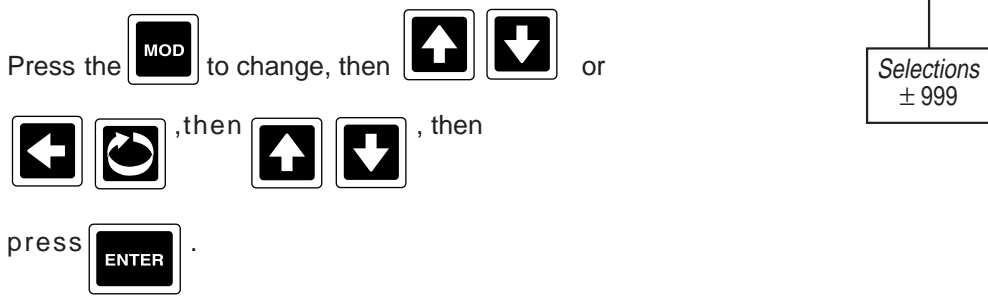









**I  
N  
P  
U  
T  
S**

8. If **INPUT TYPE/RANGE** selected was **mA**, **mV**, or **VOLT**, press the  to advance to the next parameter, **INPUT RANGE HIGH**.

**IVx INPUT RANGE HIGH**  
100.000 units

Units correspond to units configured in **INPUT TYPE/RANGE**, **mA**, **mV** or **VOLT**.







Press the  to change, then   or  , then  , then press .

Selections  
± 999

9. If **INPUT TYPE/RANGE** selected was **PULSE**, press the  to advance to the next parameter, **PULSE RATE HIGH**. (Not Yet Available)





**IVx PULSE RATE HIGH**  
1000 PULSES / SEC

Selections  
30 to 99999

Press the  to change, then  ,   to desired value, then press the .

10. If **INPUT TYPE/RANGE** selected was **COMMS**, press the  to advance to the next parameter, **COMMS ADDRESS**.

**IVx COMMS ADDRESS**  
1









Press the  to change, then   to desired address, then press the .

Selections  
1 to 247



11. If **INPUT TYPE/RANGE** selected was **COMMS**, press the  to advance to the next parameter, **COMMS REGISTER**.







Press the  to change, then   or  , then  , then press .

Selections  
0 to 65535

12. If **INPUT TYPE/RANGE** selected was **COMMS**, press the  to advance to the next parameter, **REGISTER TYPE**.





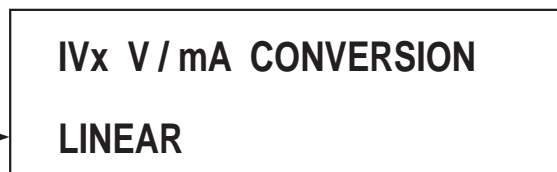

Selections  
INT LONG FLOAT

Press the  to change, then   to desired choice, then press the .

13. If **INPUT TYPE/RANGE** selected was **mA, mV, or Volt**, press the  to advance to the next parameter, **VmA CONVERSION**.





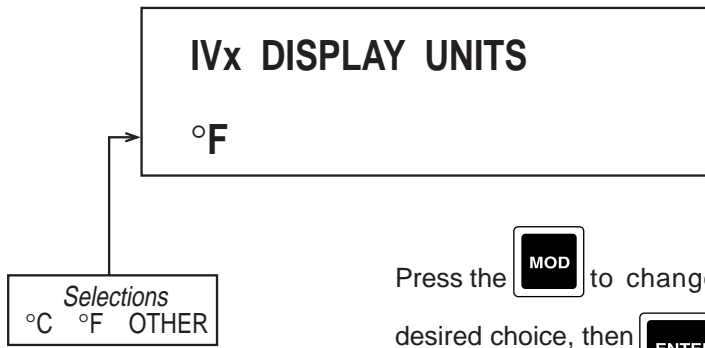

Selections  
LINEAR, SQRT, EXP

Press the  to change, then   to desired choice, then , or press the key directly below the desired choice.

14. Press the  to advance to the next parameter, **DISPLAY UNITS**.



Press the  to change, then   to desired choice, then , or press the key directly below the desired choice.



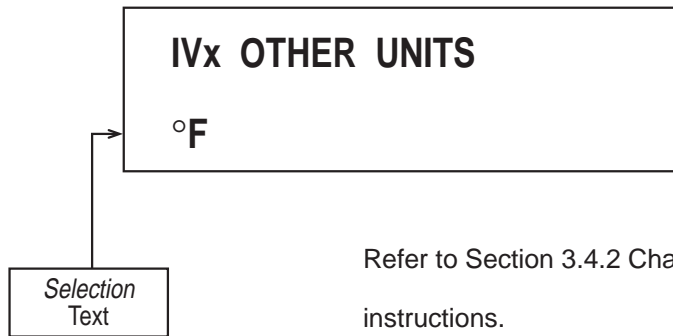

15. If **DISPLAY UNITS** selected was **OTHER**, press the  to advance to the next parameter, **OTHER UNITS**.

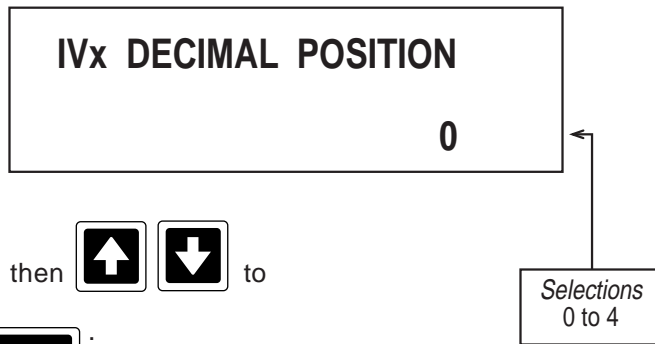

Refer to Section 3.4.2 Changing Text, page 3-3 for instructions.

16. Press the  to advance to the next parameter, **DECIMAL POSITION**.



Press the  to change, then   to desired number, then press .

17. If INPUT TYPE/RANGE selected was not SWITCH CONTACT, press the  to advance to the next parameter, RANGE LIMIT LOW.

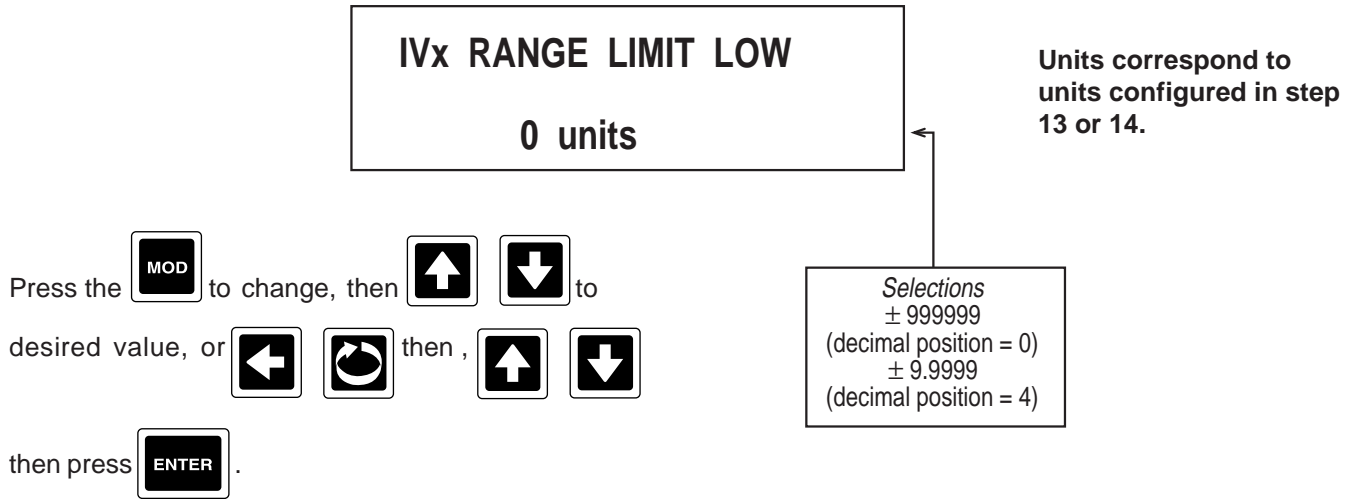

18. If INPUT TYPE/RANGE selected was not SWITCH CONTACT, press the  to advance to the next parameter, RANGE LIMIT HIGH.

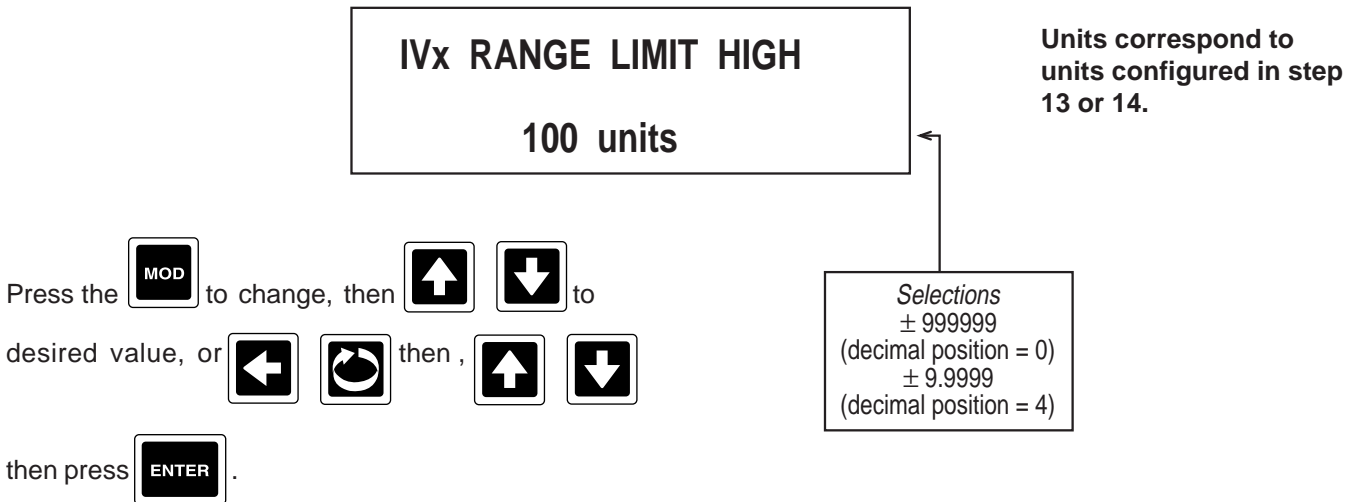

19. If V/mA conversion selected was **EXP**, press the  to advance to the next parameter, **EXPONENT**.

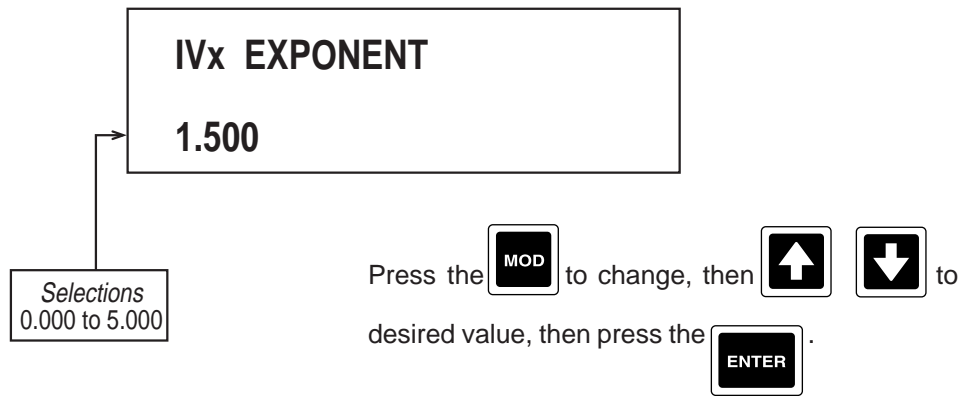

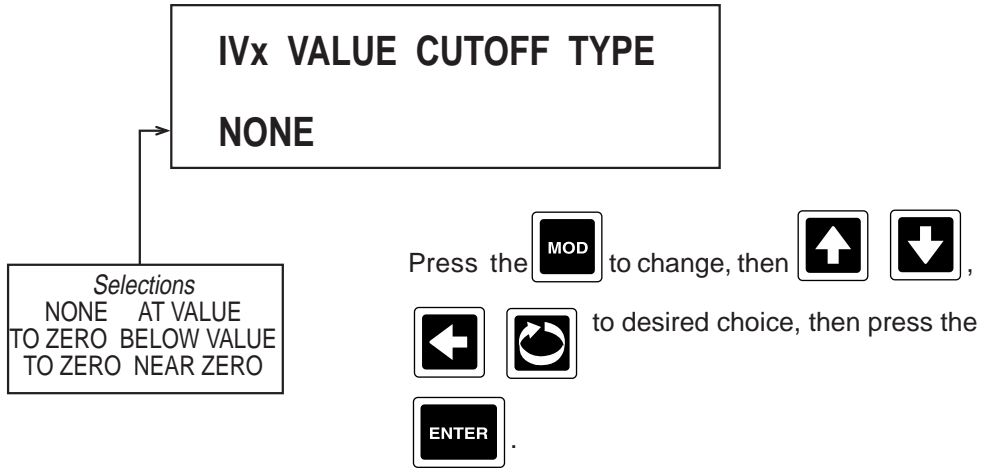

20. Press the  to advance to the next parameter, **CUTOFF TYPE**.





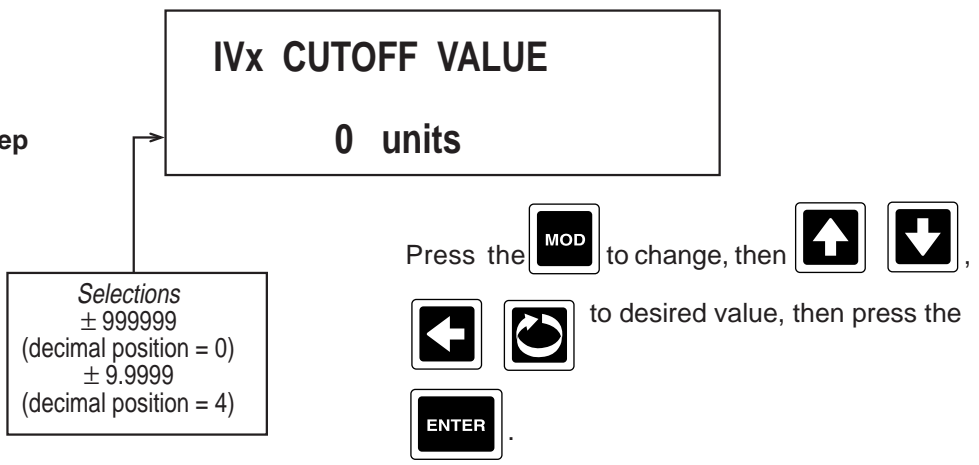



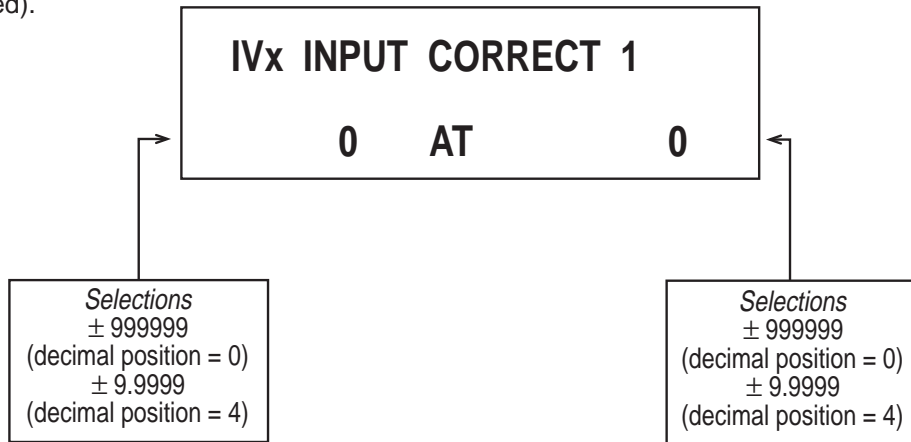

21. If **CUTOFF TYPE** selected was other than NONE, press the  to advance to the next parameter, **CUTOFF VALUE**.

Units correspond to units configured in step 14 or 15.









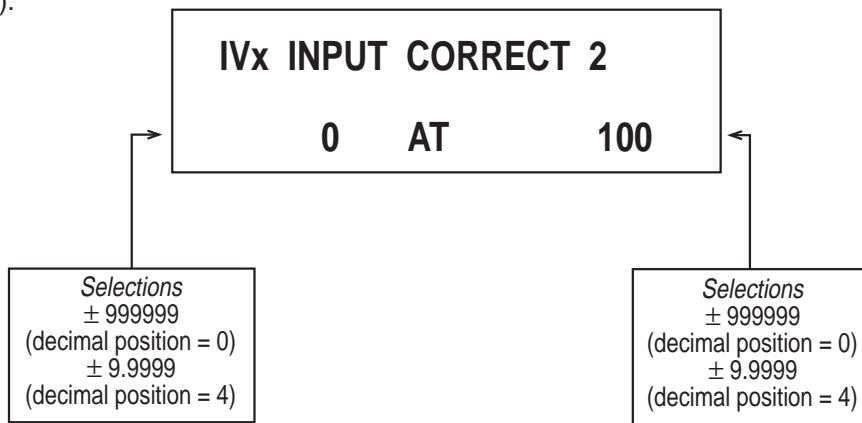

22. Press the  to advance to the next parameter, **INPUT CORRECT 1** (not seen if SWITCH CONTACT or COM was selected).



Press the  to change,   to select digit to change, then   to desired digit, then press the . This will change the correction (left number). Then change the value at which the correction will occur (right number) and press .

23. Press the  to advance to the next parameter, **INPUT CORRECT 2** (not seen if SWITCH CONTACT or COM was selected).



Press the  to change,   to select digit to change, then   to desired digit, then press the . This will change the correction (left number). Then change the value at which the correction will occur (right number) and press .

24. Press the  to advance to the next parameter, **VALUE FILTER**.

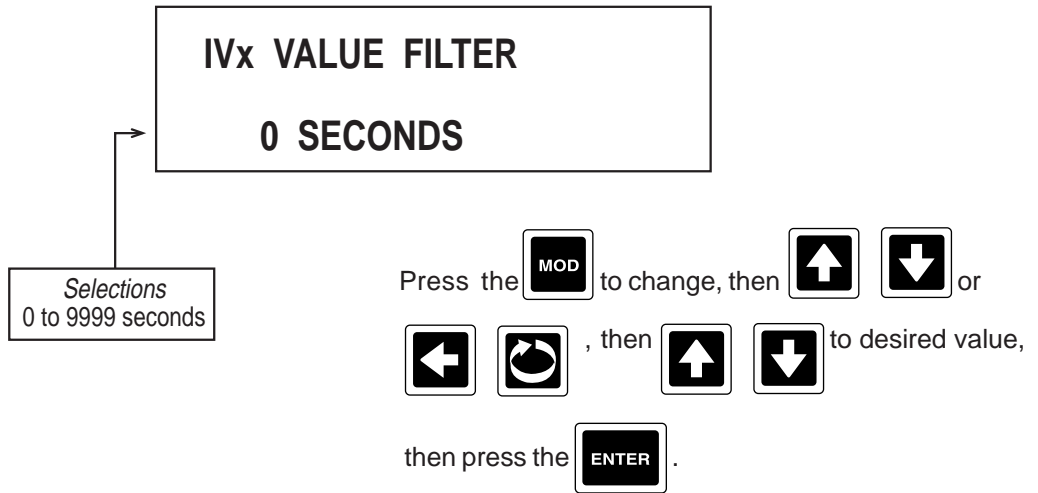

25. Press the  to advance to the next parameter, **DISPLAY OPTION**.

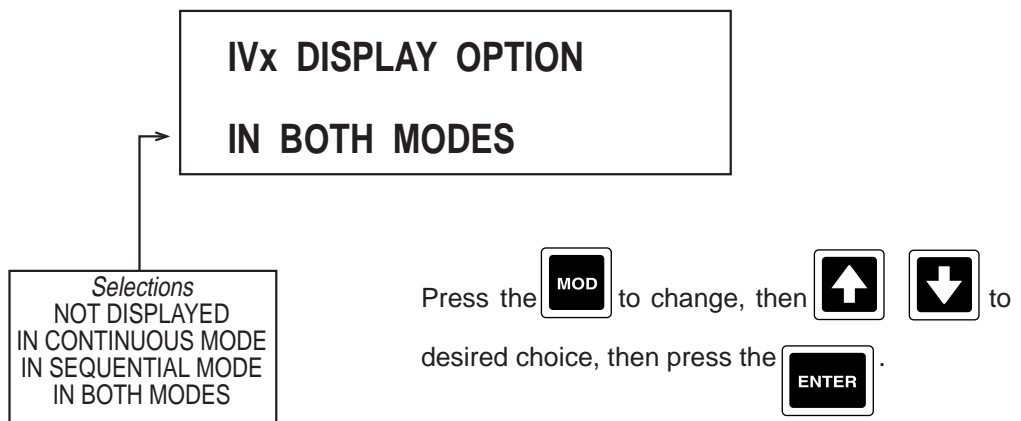

26. If **INPUT TYPE/RANGE** selected was **SWITCH CONTACT**, press the  to advance to the next parameter, **OPEN/1 DESCR..**

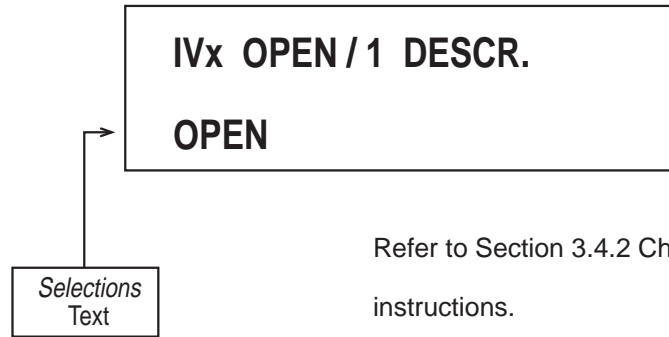

Refer to Section 3.4.2 Changing Text, page 3-3 for instructions.

27. If **INPUT TYPE/RANGE** selected was **SWITCH CONTACT**, press the  to advance to the next parameter, **CLOSED/0 DESCR..**

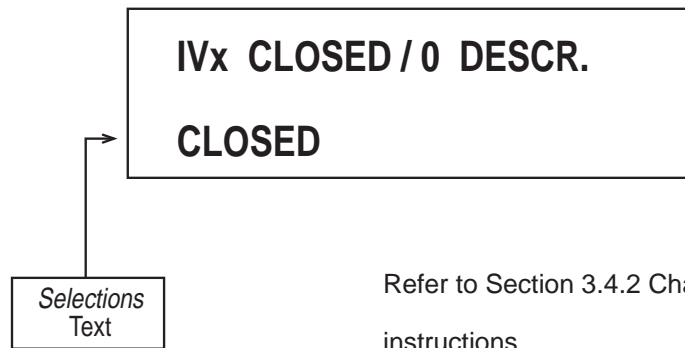

Refer to Section 3.4.2 Changing Text, page 3-3 for instructions.

28. Press the  to advance to the next parameter, **DISPLAY FILTER**.

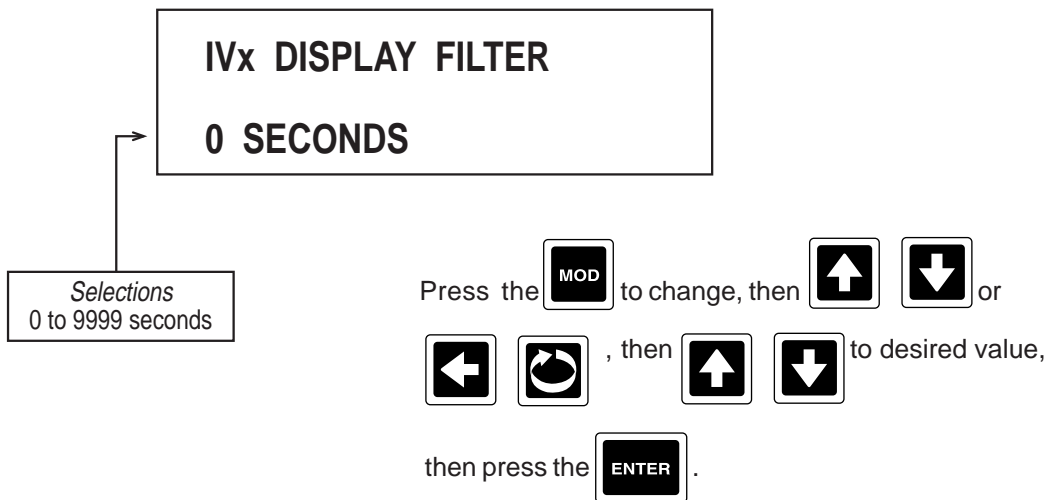

29. Press the  and the display advances to the next input to be programmed. Refer to the beginning of this section, page 4-1.

**4.1.2 CONSTANTS**

Constants are available only when MATH has been specified and present in the model number order matrix.

From the Normal Display, press the  until **CONFIGURATION** is seen in the lower display line. If **PASS-WORD** appears in the lower display line, the correct "password" will need to be entered before access to Configuration is allowed. If **CONFIGURATION** is not displayed, then Configuration has been disabled. Refer to Section 9, Enables and Passwords, for instructions to enable Configuration.

With **CONFIGURATION** in the display, press the  , then the  until **CONSTANTS** appears in the lower display line.



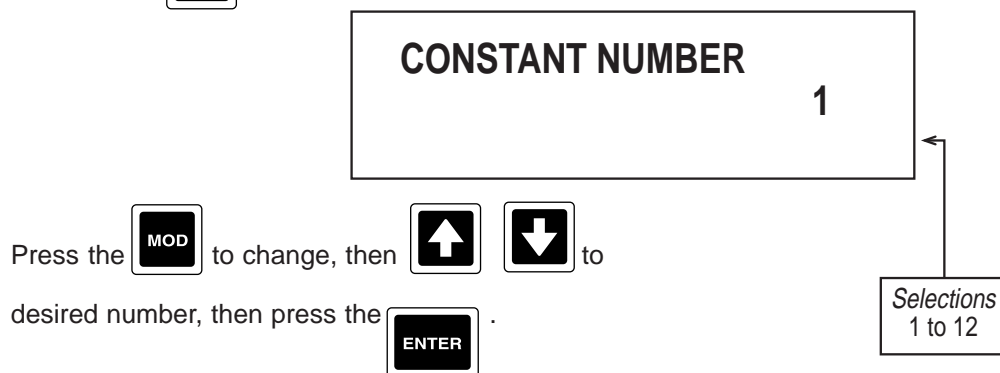

1. Press the  to display **CONSTANT NUMBER**.



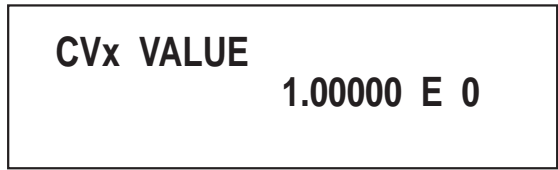



2. Press the  to advance to the next parameter, **VALUE**.



Press the  to change, then   to desired position, then   to desired number,



then press the . This will change the value (left number). Then change the exponent (right number) and then press .

3. Press the  and the display advances to the next constant to be programmed. Refer to the beginning of this section, page 4-14.

**4.1.3 CUSTOM CURVES**

Custom Curves are available only when MATH has been specified and present in the model number order matrix. Custom Curves allow the user to define up to 21 point "custom curve".





From the Normal Display, press the  until **CONFIGURATION** is seen in the lower display line. If **PASS-WORD** appears in the lower display line, the correct "password" will need to be entered before access to Configuration is allowed. If **CONFIGURATION** is not displayed, then Configuration has been disabled. Refer to Section 9, Enables and Passwords, for instructions to enable Configuration.

With **CONFIGURATION** in the display, press the , then the  until **CUSTOM CURVES** appears in the lower display line.

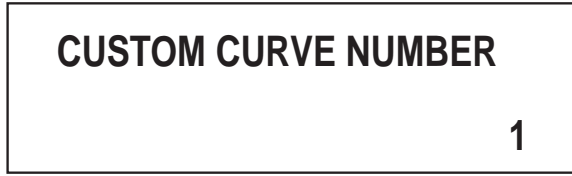
(Continued on next page)

1. Press the  to display **CUSTOM CURVE NUMBER**.





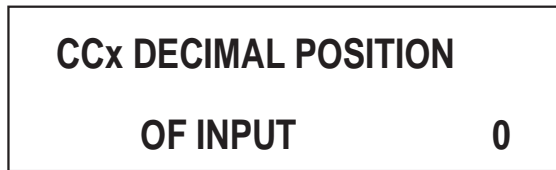

Press the  to change, then   to desired number, then press the .

Selections  
1 to 4

2. Press the  to advance to the next parameter, **DECIMAL POSITION OF INPUT**.





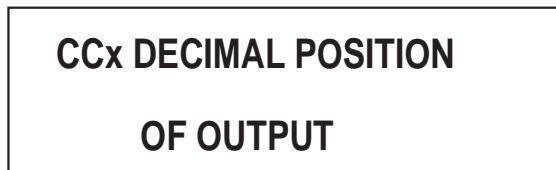

Press the  to change, then   to desired number, then press the .

Selections  
0 to 4

3. Press the  to advance to the next parameter, **DECIMAL POSITION OF OUTPUT**.





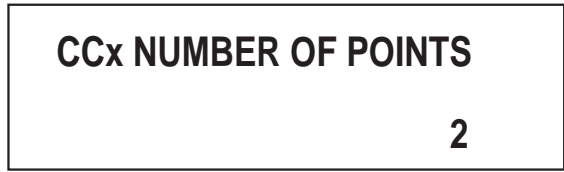

Press the  to change, then   to desired number, then press the .

Selections  
0 to 4

4. Press the  to advance to the next parameter, **NUMBER OF POINTS**.





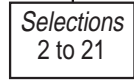



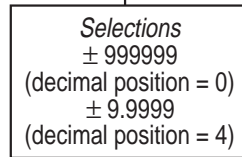
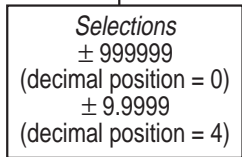

Press the  to change, then   to desired number, then press the .



5. Press the  to advance to the next parameter, **POINT PAIR 01**.



Press the  to change, then   to select digit to change, then   to desired digit, then press the . This will change the "input" value (left number). Then change the "output" value (right number) and then press the .

6. Press the  to advance to the next parameter, **POINT PAIR 02**.

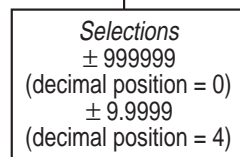
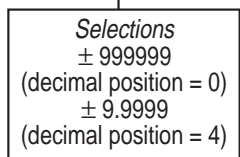

Follow the same procedure as in step 5 (above) to choose your selections.

Repeat this step for each POINT PAIR prompt for mm equal to 03 through 21 (or less).

7. Press the  and the display advances to the next custom curve to be programmed. Refer to the beginning of this section, page 4-15.

#### 4.1.4 DERIVED VARIABLES



Derived Variables utilize math to DERIVE a value from other variables and/or constants. Derived Variables are available only if MATH was specified and present in the model number order matrix.

From the Normal Display, press the  until **CONFIGURATION** is seen in the lower display line. If **PASS-WORD** appears in the lower display line, the correct "password" will need to be entered before access to Configuration is allowed. If **CONFIGURATION** is not displayed, then Configuration has been disabled. Refer to Section 9, Enables and Passwords, for instructions to enable Configuration.

With **CONFIGURATION** in the display, press the , then the  until **DERIVED VARIABLES** appears in the lower display line.

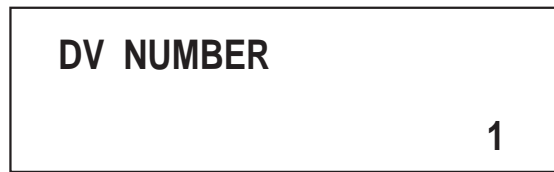
1. Press the  to display **DV NUMBER**.



Press the  to change, then   to

desired number, then press the .

Selections  
1 to 12

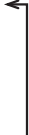



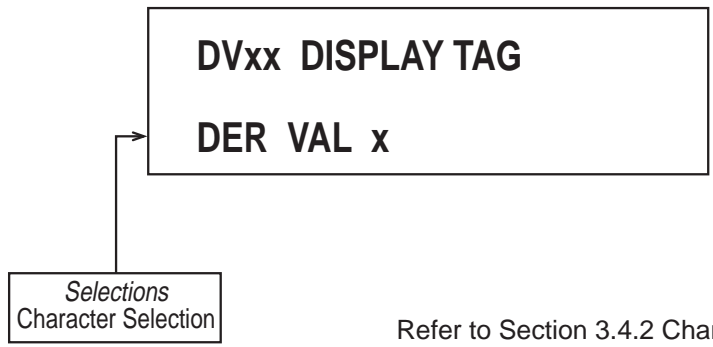



2. Press the  to advance to the next parameter, **DISPLAY TAG**.

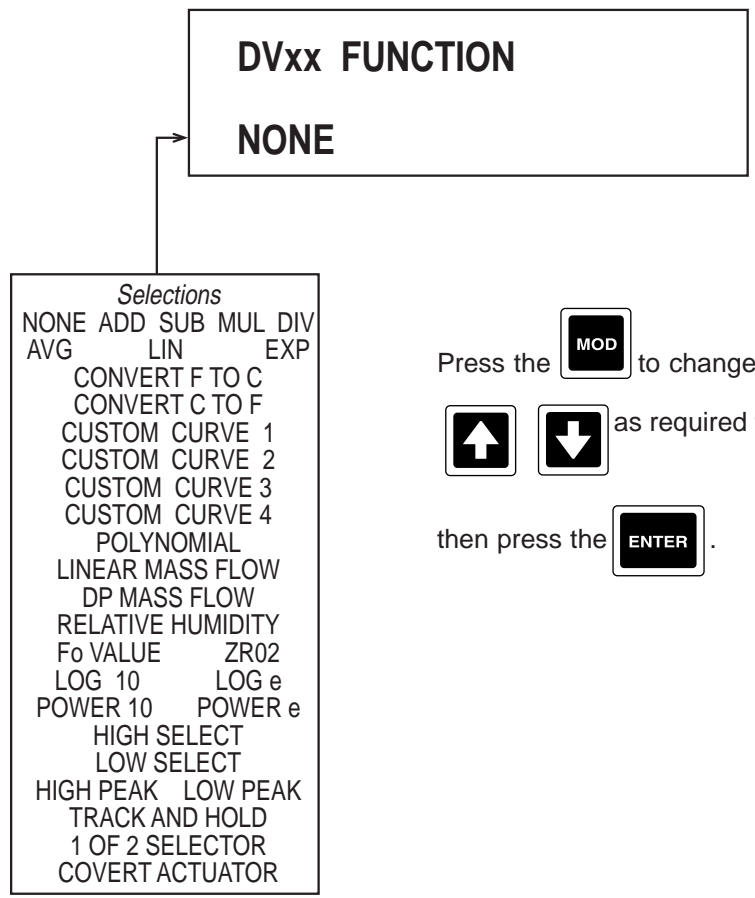

Refer to Section 3.4.2 Changing Text, page 3-3 for instructions.

3. Press the  to advance to the next parameter, **FUNCTION**. For FUNCTION descriptions, refer to the end of this section, Page 4-27.



Press the  to change, then  or  or   as required to pick desired choice, then press the .

**Continue on to next page for additional steps unless NONE was selected, in which case, no other prompts for Derived Variables X will be seen, refer back to step 1, page 4-18.**

4. Press the  to advance to the next parameter, **INPUT X**.

**DERIVED VARIABLES**

**X = INPUT** as required and specified by **FUNCTION** selection.

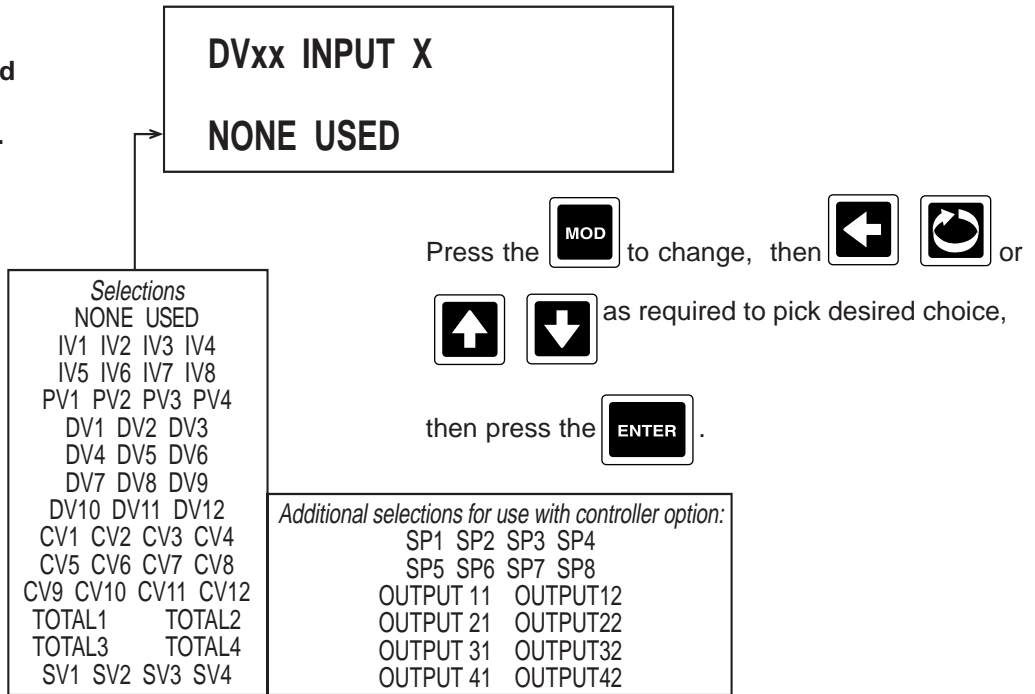

5. Press the  to advance to the next parameter, **INPUT X**, if it applies.

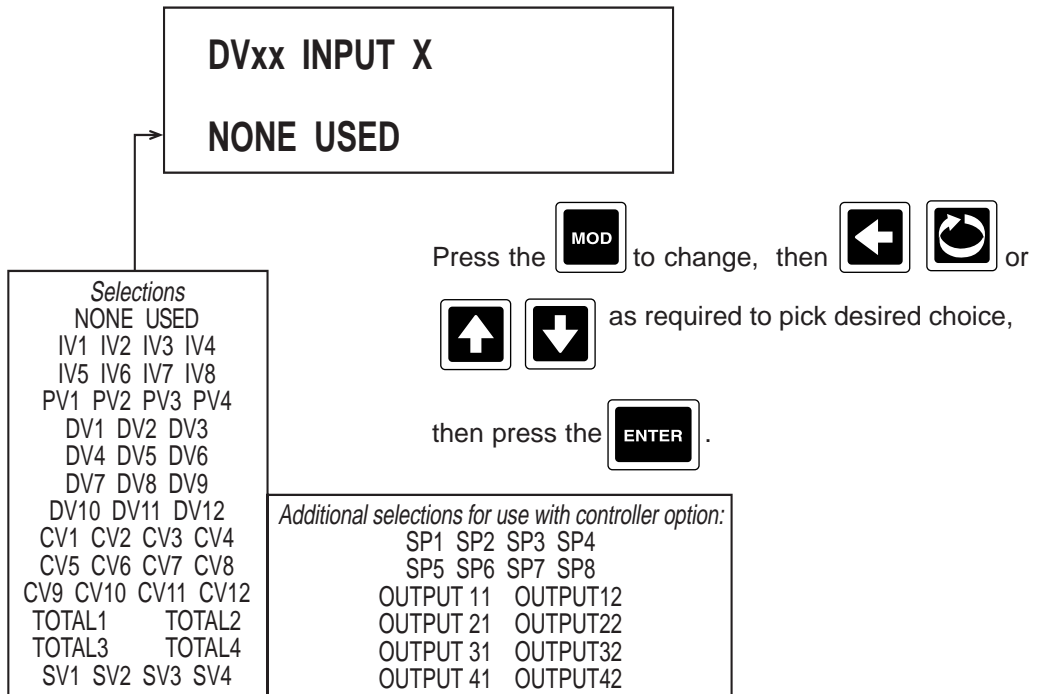



6. Press the  to advance to the next parameter, **INPUT X**, if it applies.



**DVxx INPUT X**

**NONE USED**

*Selections*

NONE USED  
 IV1 IV2 IV3 IV4  
 IV5 IV6 IV7 IV8  
 PV1 PV2 PV3 PV4  
 DV1 DV2 DV3  
 DV4 DV5 DV6  
 DV7 DV8 DV9  
 DV10 DV11 DV12  
 CV1 CV2 CV3 CV4  
 CV5 CV6 CV7 CV8  
 CV9 CV10 CV11 CV12  
 TOTAL1 TOTAL2  
 TOTAL3 TOTAL4  
 SV1 SV2 SV3 SV4

Press the  to change, then  or  or

  as required to pick desired choice,

then press the .

*Additional selections for use with controller option:*

SP1 SP2 SP3 SP4  
 SP5 SP6 SP7 SP8  
 OUTPUT 11 OUTPUT12  
 OUTPUT 21 OUTPUT22  
 OUTPUT 31 OUTPUT32  
 OUTPUT 41 OUTPUT42



7. Press the  to advance to the next parameter, **INPUT X**, if it applies.



**DVxx INPUT X**

**NONE USED**

*Selections*

NONE USED  
 IV1 IV2 IV3 IV4  
 IV5 IV6 IV7 IV8  
 PV1 PV2 PV3 PV4  
 DV1 DV2 DV3  
 DV4 DV5 DV6  
 DV7 DV8 DV9  
 DV10 DV11 DV12  
 CV1 CV2 CV3 CV4  
 CV5 CV6 CV7 CV8  
 CV9 CV10 CV11 CV12  
 TOTAL1 TOTAL2  
 TOTAL3 TOTAL4  
 SV1 SV2 SV3 SV4

Press the  to change, then  or  or

  as required to pick desired choice,

then press the .

*Additional selections for use with controller option:*

SP1 SP2 SP3 SP4  
 SP5 SP6 SP7 SP8  
 OUTPUT 11 OUTPUT12  
 OUTPUT 21 OUTPUT22  
 OUTPUT 31 OUTPUT32  
 OUTPUT 41 OUTPUT42

8. Press the  to advance to the next parameter, **INPUT X**, if it applies.

**DERIVED VARIABLES**

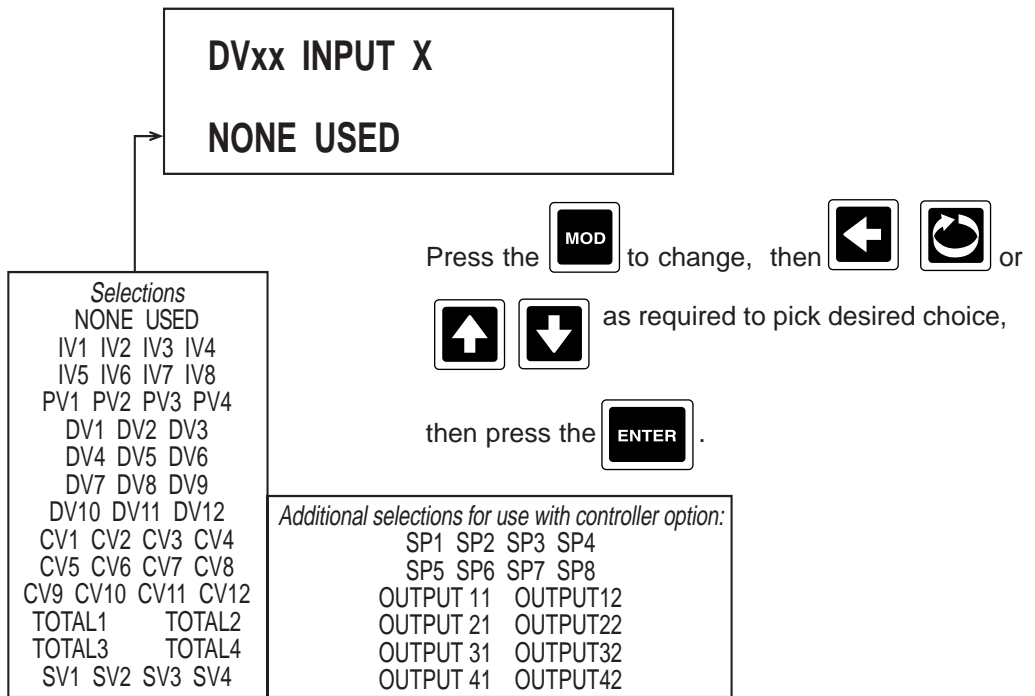











9. Press the  to advance to the next parameter, **INPUT ACTUATOR** (Only seen if an actuator is required per the FUNCTION specified).

**DVxx INPUT ACTUATOR**

**NONE / OFF**

Press the  to change, then   or   as required to pick desired choice, then press the .

*Selections*

NONE / OFF  
 ON / CONTINUOUS  
 ANY ALARM  
 ANY PROCESS ALARM  
 A11 A12 A13 A14  
 A21 A22 A23 A24  
 A31 A32 A33 A34  
 A41 A42 A43 A44  
 INSTRUMENT ALARM  
 CHART FULL  
 OP INP 1 OP INP 2  
 OP INP 3 OP INP 4  
 OP INP 5 OP INP 6  
 OP INP 7 OP INP 8  
 OP INP 9 OP INP 10  
 OP INP 11 OP INP 12  
 CHART CHANGED  
 CHART ROTATION  
 TREND DATA COLLECT  
 ALT CHART SPEED  
 DA1 DA2 DA3  
 DA4 DA5 DA6  
 DA7 DA8 DA9  
 DA10 DA11 DA12  
 DA13 DA14 DA15  
 DA16 DA17 DA18  
 DA19 DA20 DA21  
 DA22 DA23 DA24  
 PRESET 1 PRESET 2  
 PRESET 3 PRESET 4  
 TOTAL PO1 TOTAL PO2  
 TOTAL PO3 TOTAL PO4  
 TIME 1 TIME/DATE 1  
 TIME 2 TIME/DATE 2  
 TIME 1 TO TIME 2  
 TIME/DATE 1 TO 2  
 TIMER1 TIMER 2  
 TIMER 3 TIMER 4  
 SW1 SW2 SW3 SW4  
 SW5 SW6 SW7 SW8  
 COMM TRIGGER 1  
 COMM TRIGGER 2  
 COMM TRIGGER 3  
 COMM TRIGGER 4  
 F1 F2 F3 F4 F5  
 RESET MOD ENTER  
 ON THE HOUR  
 DAY OF WEEK  
 DAY OF MONTH  
 RELAY 1 RELAY 2  
 RELAY 3 RELAY 4  
 RELAY 5 RELAY 6  
 RELAY 7 RELAY 8

*Additional selections for use with controller option:*

OUTPUT 11	OUTPUT12
OUTPUT 21	OUTPUT22
OUTPUT 31	OUTPUT32
OUTPUT 41	OUTPUT42
CA1F1 CA1F2	CA1F3
CA1F4	CA1F5
CA2F1 CA2F2	CA2F3
CA2F4	CA2F5
CA3F1 CA3F2	CA3F3
CA3F4	CA3F5
CA4F1 CA4F2	CA4F3
CA4F4	CA4F5









10. Press the  to advance to the next parameter, **RESET ACTUATOR**, (Only seen if a reset actuator is required per the FUNCTION specified).

**D  
E  
R  
I  
V  
E  
D  
  
V  
A  
R  
I  
A  
B  
L  
E  
S**

**DVxx RESET ACTUATOR**  
**NONE / OFF**

- Selections*  
 NONE / OFF  
 ON / CONTINUOUS  
 ANY ALARM  
 ANY PROCESS ALARM  
 A11 A12 A13 A14  
 A21 A22 A23 A24  
 A31 A32 A33 A34  
 A41 A42 A43 A44  
 INSTRUMENT ALARM  
 CHART FULL  
 OP INP 1 OP INP 2  
 OP INP 3 OP INP 4  
 OP INP 5 OP INP 6  
 OP INP 7 OP INP 8  
 OP INP 9 OP INP 10  
 OP INP 11 OP INP 12  
 CHART CHANGED  
 CHART ROTATION  
 TREND DATA COLLECT  
 ALT CHART SPEED  
 DA1 DA2 DA3  
 DA4 DA5 DA6  
 DA7 DA8 DA9  
 DA10 DA11 DA12  
 DA13 DA14 DA15  
 DA16 DA17 DA18  
 DA19 DA20 DA21  
 DA22 DA23 DA24  
 PRESET 1 PRESET 2  
 PRESET 3 PRESET 4  
 TOTAL PO1 TOTAL PO2  
 TOTAL PO3 TOTAL PO4  
 TIME 1 TIME/DATE 1  
 TIME 2 TIME/DATE 2  
 TIME 1 TO TIME 2  
 TIME/DATE 1 TO 2  
 TIMER1 TIMER 2  
 TIMER 3 TIMER 4  
 SW1 SW2 SW3 SW4  
 SW5 SW6 SW7 SW8  
 COMM TRIGGER 1  
 COMM TRIGGER 2  
 COMM TRIGGER 3  
 COMM TRIGGER 4  
 F1 F2 F3 F4 F5  
 RESET MOD ENTER  
 ON THE HOUR  
 DAY OF WEEK  
 DAY OF MONTH  
 RELAY 1 RELAY 2  
 RELAY 3 RELAY 4  
 RELAY 5 RELAY 6  
 RELAY 7 RELAY 8

Press the  to change, then  or  or   as required to pick desired choice, then press the .

11. Press the  to advance to the next parameter, **DISPLAY UNITS**.

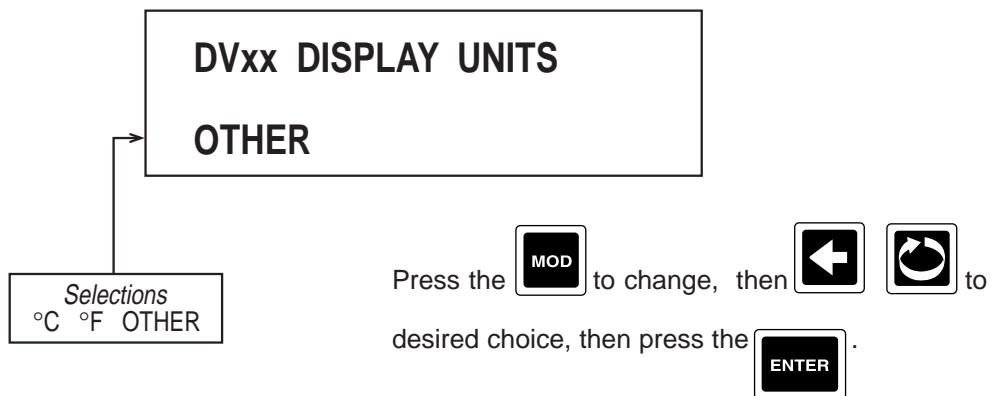

12. Press the  to advance to the next parameter, **UNITS DESCRIP** (only seen if OTHER was selected as DISPLAY UNITS)

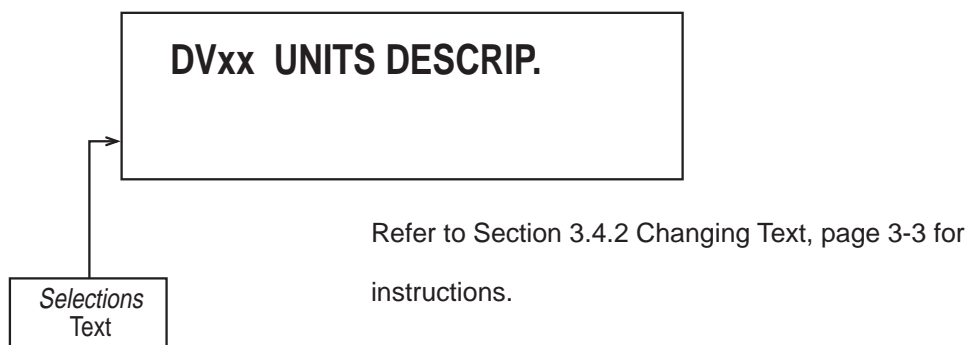

13. Press the  to advance to the next parameter, **DECIMAL POSITION**.

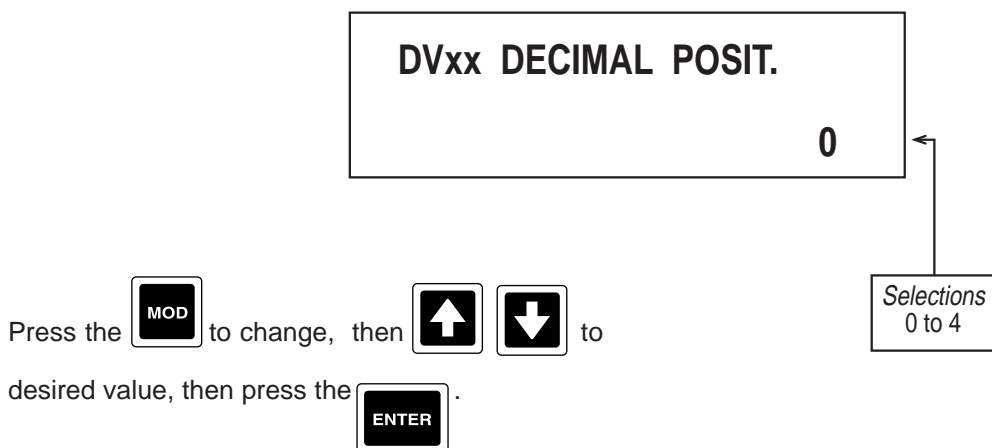

14. Press the  to advance to the next parameter, **VALUE FILTER**.

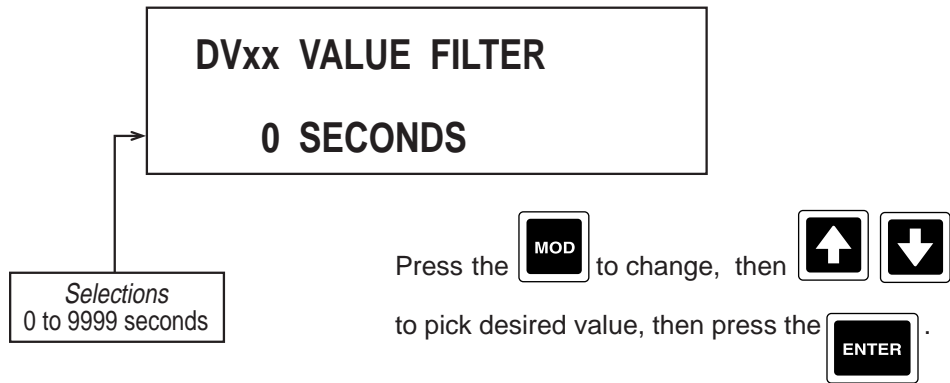

15. Press the  to advance to the next parameter, **DISPLAY OPTION**.

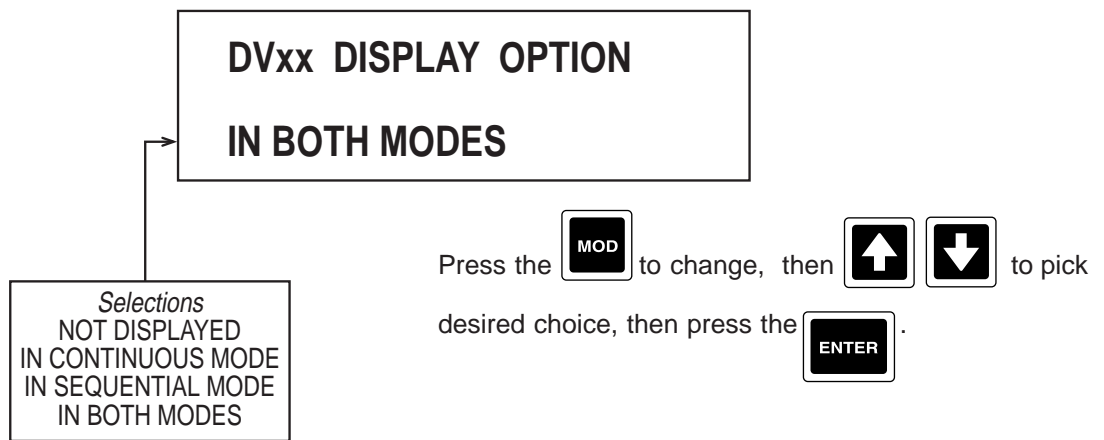

16. Press the  to advance to the next parameter, **DISPLAY FILTER**.

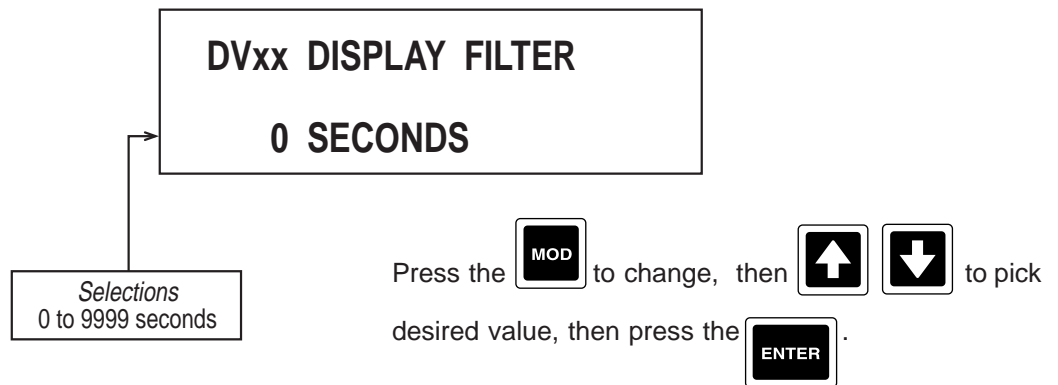

17. Press the  and the display advances to the next derived input to be programmed. Refer to the beginning of this section, page 4-18.

## **DERIVED VARIABLE FUNCTION**

To simplify formulas or make them easier to read, various letters or abbreviations are used for the inputs, such as A, B, X, or TEMP. During configuration, a descriptive prompt will appear on line 1, as specified by "PROMPT:" for each input, while the source of the input is selected via a choice of inputs on line 2.

A Derived Variable can have up to five value inputs, one actuator input, and a reset actuator. The description for each Derived Variable Function identifies its corresponding inputs. Input choices set to NONE USED will evaluate to zero unless specified otherwise.

Unless specifically stated, it is assumed that all values have been converted to the proper scale and units before being used as an input. In some cases, temperatures will be automatically converted to the required units as specified. Should a divide by zero be attempted, the result will be set to 99999.

### 1. SUB, MUL, DIV, EXP, LOG 10, LOG e, POWER 10, POWER e

INPUT 1:	A	PROMPT:	DVxx INPUT A
INPUT 2:	B	PROMPT:	DVxx INPUT B
ACTUATOR:	n/a		
RESET:	n/a		
OUTPUT:	= A-B	for SUB	- Subtraction
	= A*B	for MUL	- Multiplication
	= A/B	for DIV	- Division
	= A**B	for EXP	- Exponent
	= B*LOG(A)	for LOG 10	- Log to the Base 10
	= B*LN (A)	for LOG e	- Natural Log
	= B*10**A	for POWER 10	- Power of 10
	= B*e**A	for POWER e	- Power of e

For LOG 10, LOG e, POWER 10, and POWER e, if INPUT 2 is "NOT USED" then B=1.

### 2. LIN - LINEAR

INPUT 1:	X	PROMPT:	DVxx INPUT X
INPUT 2:	A	PROMPT:	DVxx INPUT A
INPUT 3:	B	PROMPT:	DVxx INPUT B
ACTUATOR:	n/a		
RESET:	n/a		
OUTPUT:	= A*X+B		

### 3. CUSTOM CURVE 1, through CUSTOM CURVE 4

INPUT 1:	X	PROMPT:	DVxx INPUT
ACTUATOR:	n/a		
RESET:	n/a		
OUTPUT:	= Extrapolated result using the corresponding CUSTOM CURVE.		

NOTES: The OUTPUT will be limited by the output values of the first and last POINT PAIR entries.

4. POLYNOMIAL

INPUT 1:	X	PROMPT:	DVxx INPUT X
INPUT 2:	A	PROMPT:	DVxx INPUT A
INPUT 3:	B	PROMPT:	DVxx INPUT B
INPUT 4:	C	PROMPT:	DVxx INPUT C
INPUT 5:	D	PROMPT:	DVxx INPUT D
ACTUATOR:	n/a		
RESET:	n/a		
OUTPUT:	= A*X**3 + B*X**2 + C*X + D		

5. LINEAR MASS FLOW - AGA 3 LINEAER GAS FLOW

INPUT 1:	F	PROMPT:	DVxx RAW FLOW
INPUT 2:	PRES	PROMPT:	DVxx STATIC PRES ABS
INPUT 3:	TEMPF	PROMPT:	DVxx FLOW TEMP°F
INPUT 4:	COMP	PROMPT:	DVxx COMP. CORRECT.
INPUT 5:	C	PROMPT:	DVxx SCALING CONST.
ACTUATOR:	n/a		
RESET:	n/a		
OUTPUT:	=C*F*SQRT (PRES/(TEMPR*COMP)) where: TEMPR = TEMPF + 459.67		

If INPUT 1 is "NOT USED", then F=1  
If INPUT 2 is "NOT USED", then PRES=1  
If INPUT 3 is "NOT USED", then TEMPR=1 (not TEMPF)  
If INPUT 4 is "NOT USED", then COMP=1  
If INPUT 5 is "NOT USED", then C=1

NOTES: F - Raw Linear Fow Input  
PRES - Static Pressure - must be ABSOLUTE  
TEMPF - Flow Temperature - must be degrees F  
COMP - Compressibility Correction  
C - Scaling Constant

This function converts TEMP from degrees F to degrees R in the equation.

6. DP MASS FLOW - AGA 3 DP GAS FLOW

INPUT 1:	DP	PROMPT:	DVxx DIFFERENT. PRES
INPUT 2:	PRES	PROMPT:	DVxx STATIC PRES ABS
INPUT 3:	TEMPF	PROMPT:	DVxx FLOW TEMP °F
INPUT 4:	COMP	PROMPT:	DVxx COMP. CORRECT.
INPUT 5:	C	PROMPT:	DVxx SCALING CONST.
ACTUATOR:	n/a		
RESET:	n/a		
OUTPUT:	= C*SQRT ((DP*PRES) / (TEMPR*COMP)) where TEMPR = TEMPF + 459.67)		

If INPUT 1 is "NOT USED", then DP=1  
If INPUT 2 is "NOT USED", then PRES=1  
If INPUT 3 is "NOT USED", then TEMPR=1 (not TEMPF)  
If INPUT 4 is "NOT USED", then COMP=1  
If INPUT 5 is "NOT USED", then C=1

NOTES: DP - Differential Pressure  
 PRES - Static Pressure - must be ABSOLUTE  
 TEMPF - Flow Temperature - must be degrees F  
 COMP - Compressibility Correction  
 C - Scaling Constant

This function converts TEMP from degrees F to degrees R in the equation.

7. RELATIVE HUMIDITY

INPUT 1: DBT PROMPT: DVxx DRY BULB TEMP°F  
 INPUT 2: WBT PROMPT: DVxx WET BULB TEMP°F  
 INPUT 3: BARO PROMPT: DVxx BARO. PRES "Hg  
 ACTUATOR: n/a  
 RESET: n/a  
 OUTPUT: = RELATIVE HUMIDITY in PERCENT (0 to 100 typ)

If INPUT 3 is "NOT USED", then BARO=29.921

NOTES: DBT - DRY BULB TEMPERATURE - must be in degrees F  
 WBT - WET BULB TEMPERATURE - must be in degrees F  
 BARO - ATMOSPHERIC PRESSURE - must be in "Hg (inches of Mercury)

8. Fo VALUE - STERILIZATION CONSTANT Fo

INPUT 1: INTEMP PROMPT: DVxx INPUT TEMP  
 INPUT 2: STEMP PROMPT: DVxx STERILIZE TEMP  
 INPUT 3: Z PROMPT: DVxx "Z" VALUE  
 ACTUATOR: n/a  
 RESET: YES PROMPT: DVxx RESET ACTUATOR  
 OUTPUT: =  $DV + (10^{**}A)/60$  where:  $A=(INTEMP - STEMP) / Z$   
 DV is the previous result

NOTES: INTEMP - Input Temperature  
 STEMP - Sterilizing Temperature  
 Z - "Z" Value

The TEMPERATURE can be degrees F or C, but the "Z" value must take this into account.  
 Whenever RESET is active, DV will be set to zero.  
 The units of the resultant DV is MINUTES  
 This function is calculated once a second.

9. ZRO2 - ZIRCONIA OXYGEN SENSOR

INPUT 1: PP PROMPT: DVxx PARTIAL PRES  
 INPUT 2: EMF PROMPT: DVxx PROBE EMF mV  
 INPUT 3: TEMP PROMPT: DVxx PROBE TEMP °C  
 ACTUATOR: n//a  
 RESET: n/a  
 OUTPUT: =  $PP/(10^{**}B)$  where:  $B=EMF/(0.0496 * (TEMP+273.18))$

NOTES: PP - Partial Pressure - must be in Percent  
 EMF - Probe EMF - must be Millivolts  
 TEMP - Probe Temperature - must be degrees C

This function covers TEMP from degrees C to degrees K in the equation

10. HIGH SELECT and LOW SELECT

INPUT 1: A                      PROMPT: DVxx INPUT A  
INPUT 2: B                      PROMPT: DVxx INPUT B  
ACTUATOR: n/a  
RESET: n/a  
OUTPUT: = HIGHER of A and B for HIGH SELECT  
          = LOWER of A and B for LOW SELECT

11. HIGH PEAK

INPUT 1: A                      PROMPT: DVXX INPUT  
ACTUATOR: n/a  
RESET: YES                      PROMPT: DVxx RESET ACTUATOR  
OUTPUT: = HIGHEST VALUE of A since last RESET  
          Whenever RESET is active, the HIGHEST VALUE will be the current value of A.

12. LOW PEAK

INPUT 1: A                      PROMPT: DVxx INPUT  
ACTUATOR: n/a  
RESET: YES                      PROMPT: DVXX RESET ACTUATOR  
OUTPUT: = LOWEST VALUE of A since last RESET.  
          Whenever RESET is active, the LOWEST VALUE will be the current value of A.

13. TRACK AND HOLD

INPUT 1: A                      PROMPT: DVxx INPUT  
ACTUATOR: YES                      PROMPT: DVxx TRACK ACTUATOR  
RESET: n/a  
OUTPUT: = Current value of A if the state of the Selected Actuator is true  
          = Last value of A when the state of the Selected Actuator changed from true to false

14. 1 of 2 SELECTOR

INPUT 1: A                      PROMPT: DVxx INPUT A  
INPUT 2: B                      PROMPT: DVxx INPUT B  
ACTUATOR: YES                      PROMPT: DVxx SELECT B ACTUAT  
RESET: n/a  
OUTPUT: = A if the state of the Selected Actuator is false.  
          = B if the state of the Selected Actuator is true.

15. CONVERT ACTUATOR

ACTUATOR: YES                      PROMPT: DVxx ACTUATOR  
RESET: n/a  
OUTPUT: = 0.0 if the state of the Selected Actuator is false  
          = 1.0 if the state of the Selected Actuator is true.

16. CONVERT F TO C

INPUT 1: A                      PROMPT: DVxx INPUT°F  
ACTUATOR: n/a  
RESET: n/a  
OUTPUT: =  $(A-32) * 5/9$



17. CONVERT C TO F

INPUT 1:	A	PROMPT:	DVxx INPUT°C
ACTUATOR:	n/a		
RESET:	n/a		
OUTPUT:	= (A * 9/5) +32		

18. BTU

INPUT 1:	F	PROMPT:	DVxx FLOW
INPUT 2:	TEMPH	PROMPT:	DVxx HIGHER TEMP
INPUT 3:	TEMPL	PROMPT:	DVxx LOWER TEMP
INPUT 4:	C	PROMPT:	DVxx SCALING CONST.
ACTUATOR:	n/a		
RESET:	n/a		
OUTPUT:	= C*F* (TEMPH-TEMPL)		

If INPUT 4 is "NOT USED", then C=1

NOTES: F - Flow  
 TEMPH - Higher Temperature for DeltaT  
 TEMPL - Lower Temperature for DeltaT  
 C - Scaling Constant

The Temperatures can be degrees F or C, but the scaling constant must take this into account.

19. ADD

INPUT 1:	A	PROMPT:	DVxx INPUT 1
INPUT 2:	B	PROMPT:	DVxx INPUT 2
INPUT 3:	C	PROMPT:	DVxx INPUT 3
INPUT 4:	D	PROMPT:	DVxx INPUT 4
ACTUATOR:	n/a		
RESET:	n/a		
OUTPUT:	= A+B+C+D		

20. AVG

INPUT 1:	A	PROMPT:	DVxx INPUT 1
INPUT 2:	B	PROMPT:	DVxx INPUT 2
INPUT 3:	C	PROMPT:	DVxx INPUT 3
INPUT 4:	D	PROMPT:	DVxx INPUT 4
ACTUATOR:	n/a		
RESET:	n/a		
OUTPUT:	= (A+B+C+D)/E		

Where E is the number of inputs that are CONFIGURED.

### 4.1.5 PROCESS VARIABLES

Process Variables define variables for use with alarms and/or control outputs

From the Normal Display, press the  until **CONFIGURATION** is seen in the lower display line. If **PASS-WORD** appears in the lower display line, the correct "password" will need to be entered before access to Configuration is allowed. If **CONFIGURATION** is not displayed, then Configuration has been disabled. Refer to Section 9, Enables and Passwords, for instructions to enable Configuration.

With **CONFIGURATION** in the display, press the , then the  until **PROCESS VARIABLES** appears in the lower display line.

1. Press the  to display **PROCESS VALUE NUMBER**.

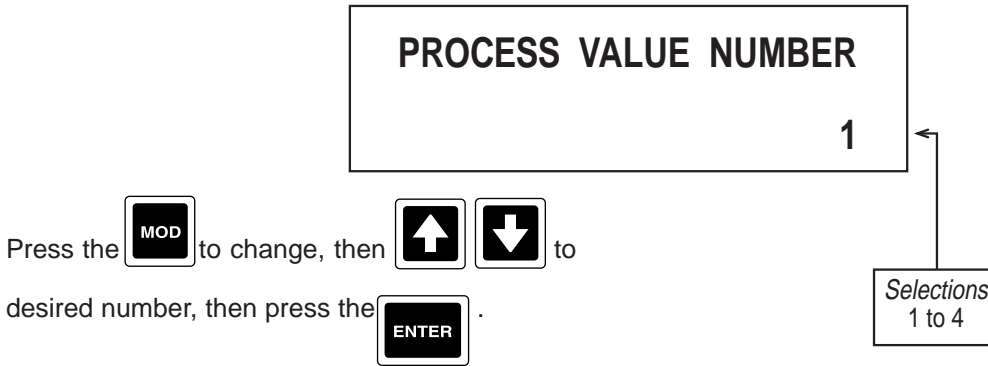

2. Press the  to advance to the next parameter, **COPY/INITIALIZE**.

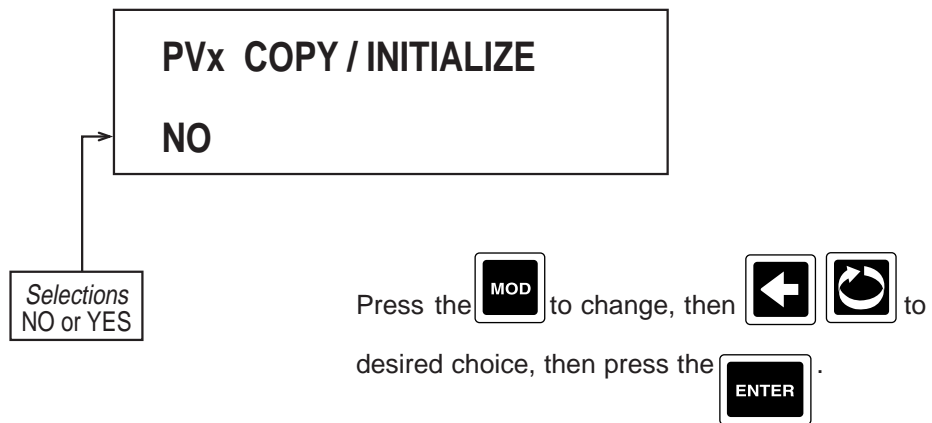



Select YES if the parameters to be programmed are the same as another PROCESS VARIABLE already programmed.

If selection is NO, proceed to step 3.

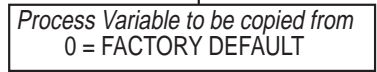
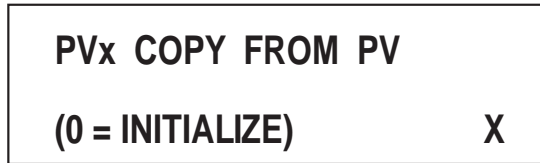
If selection is YES:



Press the   to change to the process variable to be copied from.

3. Press the  to advance to the next parameter, **DISPLAY TAG**.

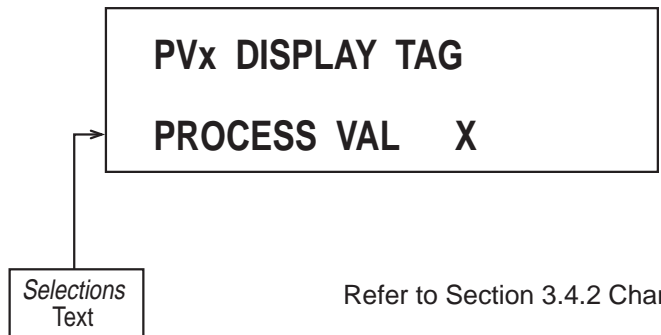

Refer to Section 3.4.2 Changing Text, page 3-3 for instructions.

4. Press the  to advance to the next parameter, **INPUT TYPE**.

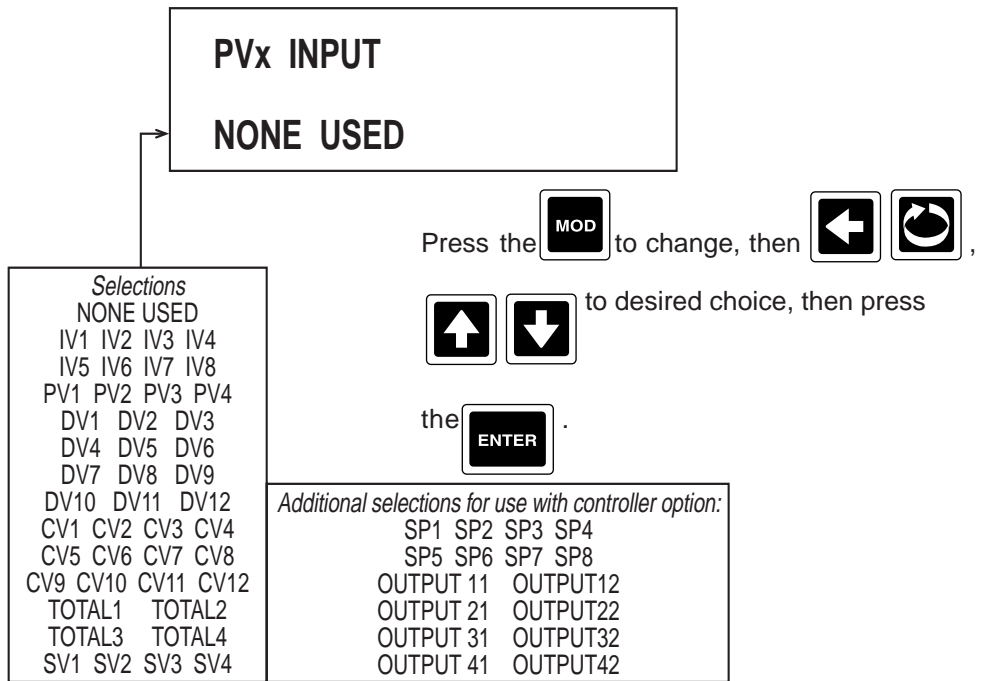

*If NONE USED was selected, no other prompts for PROCESS VALUE X will be seen. Refer back to step 1, page 4-32.*

5. Press the  to advance to the next parameter, **DISPLAY UNITS**.

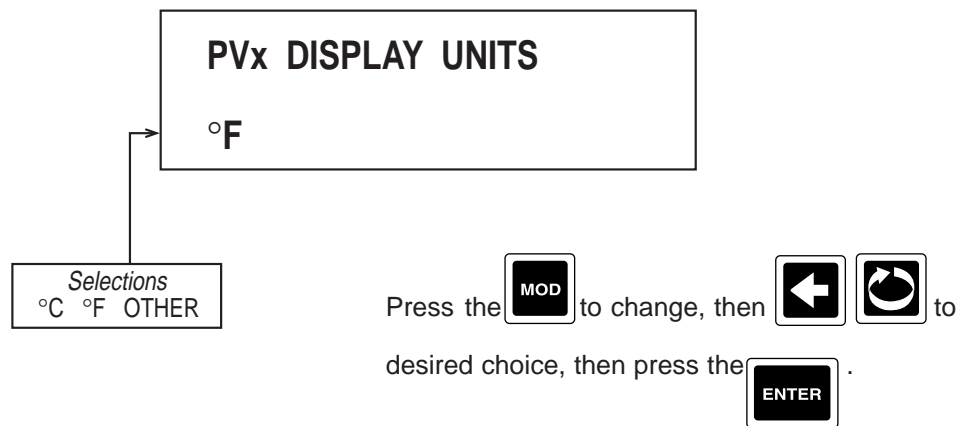



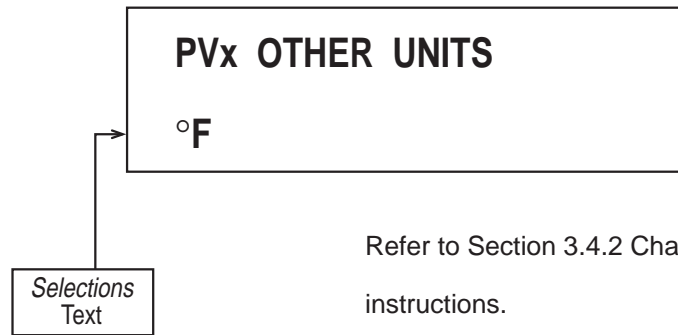

6. If **OTHER** was selected in **DISPLAY UNITS**, press the  to advance to the next parameter, **OTHER UNITS**.



Refer to Section 3.4.2 Changing Text, page 3-3 for instructions.

7. Press the  to advance to the next parameter, **DECIMAL POSITION**.





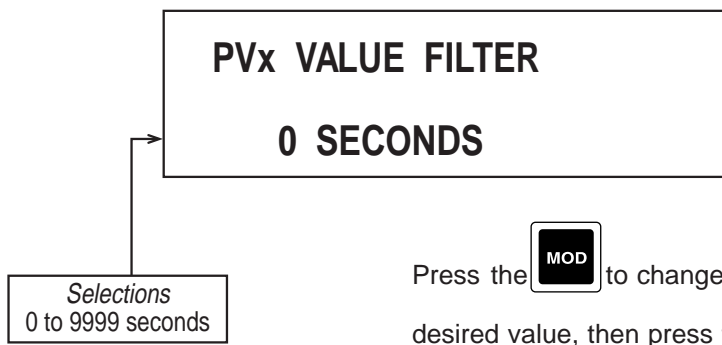

Press the  to change, then   to desired value, then press the .

Selections  
0 to 4

8. Press the  to advance to the next parameter, **VALUE FILTER**.







Press the  to change, then   to desired value, then press the .

9. Press the  to advance to the next parameter, **DISPLAY OPTION**.

**PVx DISPLAY OPTION  
IN BOTH MODES**





*Selections  
NOT DISPLAYED  
IN CONTINUOUS MODE  
IN SEQUENTIAL MODE  
IN BOTH MODES*

Press the  to change, then   to desired choice, then press the .

10. Press the  to advance to the next parameter, **DISPLAY FILTER**.

**PVx DISPLAY FILTER  
0 SECONDS**

*Selections  
0 to 9999 seconds*

Press the  to change, then   to desired value, then press the .







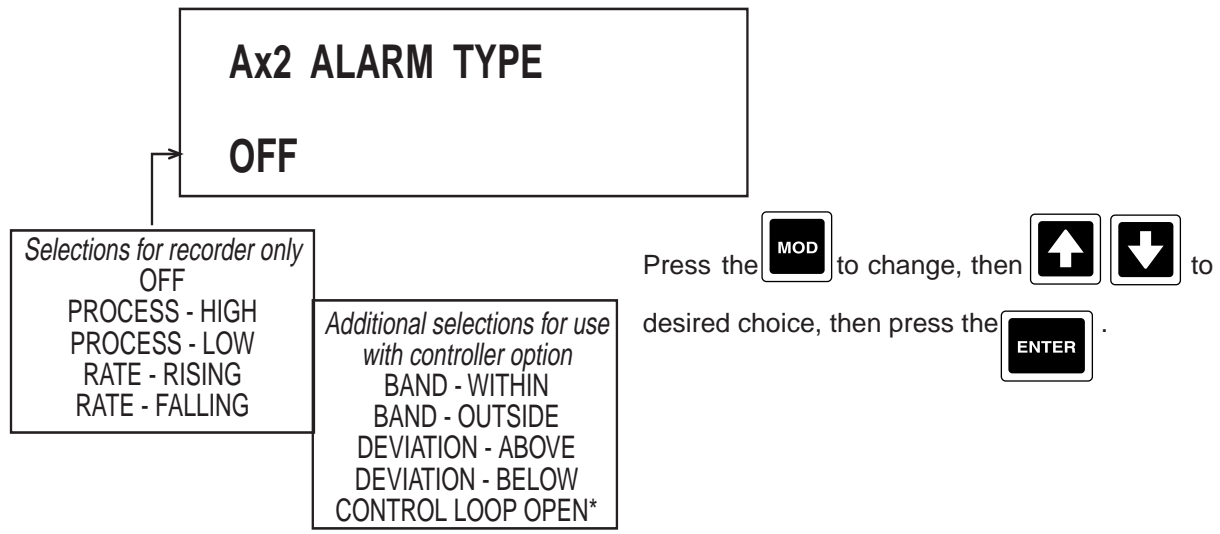

15. Press the  to advance to the next parameter, **ALARM 2 TYPE**.



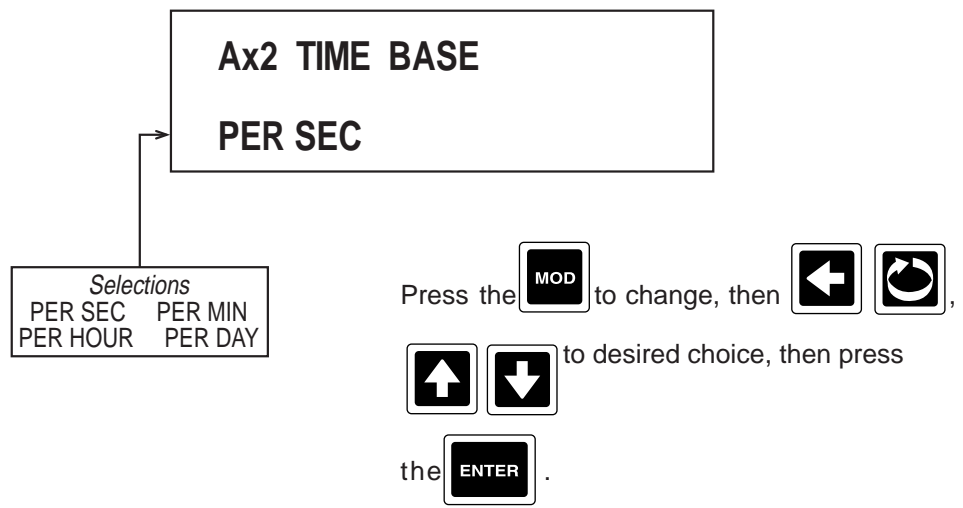

\* When CONTROL LOOP OPEN is selected for ALARM TYPE and NON PID is selected for CONTROL TYPE (CONTROLLERS section of CONFIGURATION), prompt LOOP ALARM TYPE will be displayed

16. Press the  to advance to the next parameter, **ALARM 2 TIME BASE** (only seen if Ax2 TYPE is RATE).

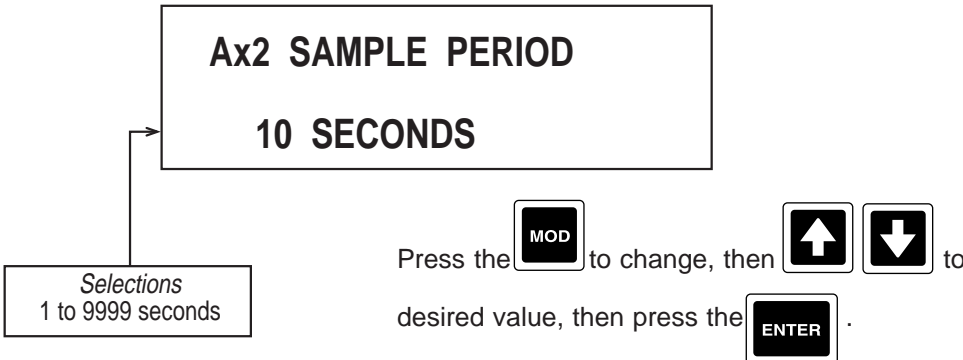

17. Press the  to advance to the next parameter, **ALARM 2 SAMPLE PERIOD** (only seen if Ax2 TYPE is RATE).



18. Press the  to advance to the next parameter, **ALARM 2 HYSTERESIS**.

**Note: Units correspond to units configured in Process Variables.**

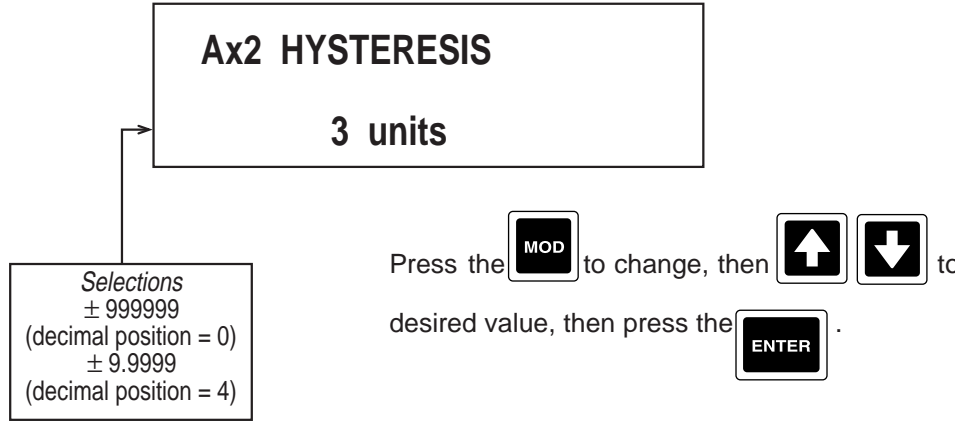

**NOTE: If RATE Alarm is selected, Hysteresis equals RATE in units/TIME BASE.**

19. Press the  to advance to the next parameter, **ALARM 3 TYPE**.

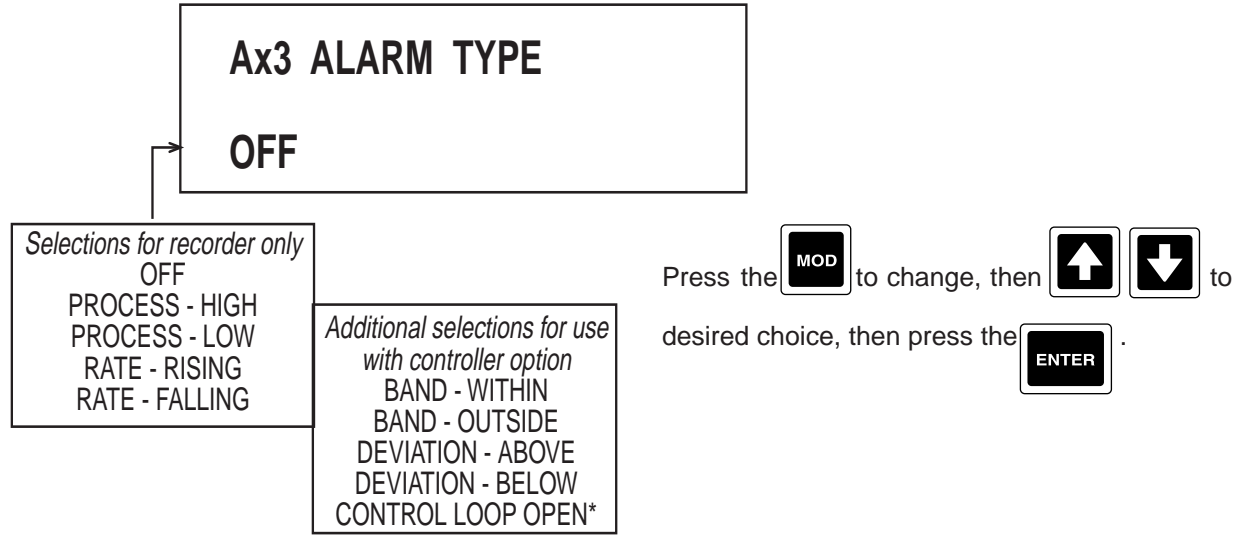

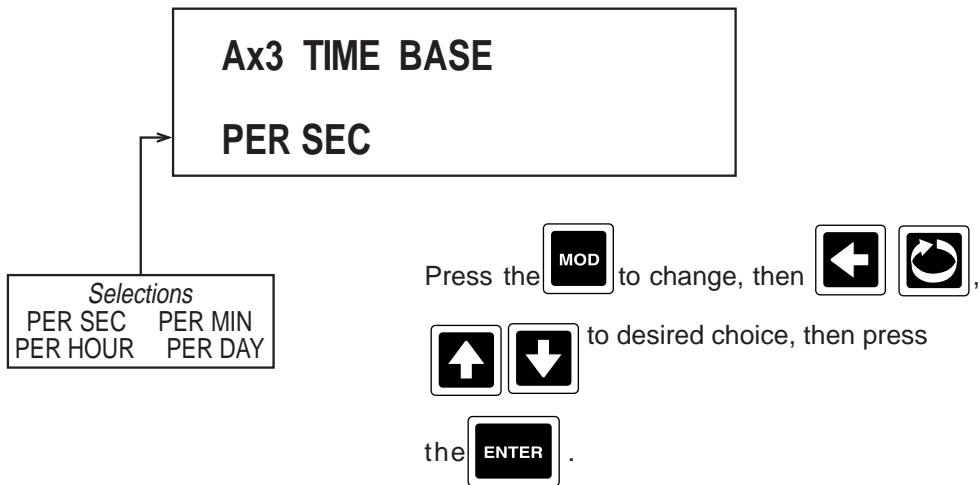

\* When CONTROL LOOP OPEN is selected for ALARM TYPE and NON PID is selected for CONTROL TYPE (CONTROLLERS section of CONFIGURATION), prompt LOOP ALARM TYPE will be displayed.

20. Press the  to advance to the next parameter, **ALARM 3 TIME BASE** (only seen if Ax3 TYPE is RATE).

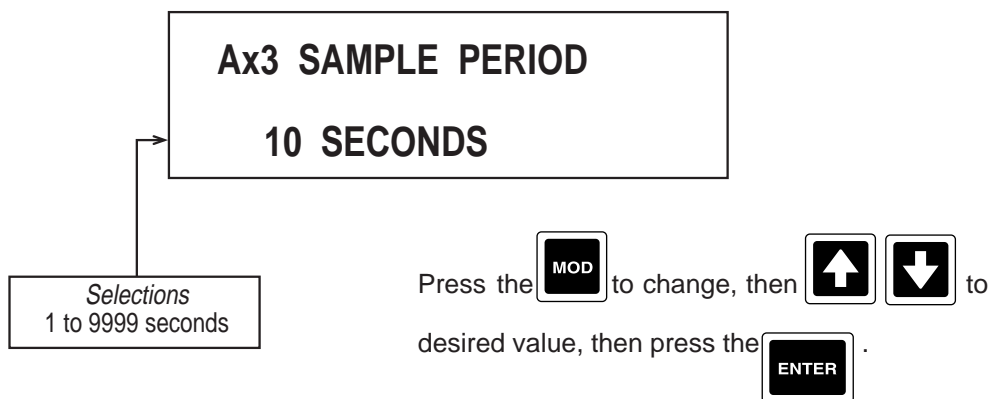

21. Press the  to advance to the next parameter, **ALARM 3 SAMPLE PERIOD** (only seen if Ax3 TYPE is RATE).



22. Press the  to advance to the next parameter, **ALARM 3 HYSTERESIS**.

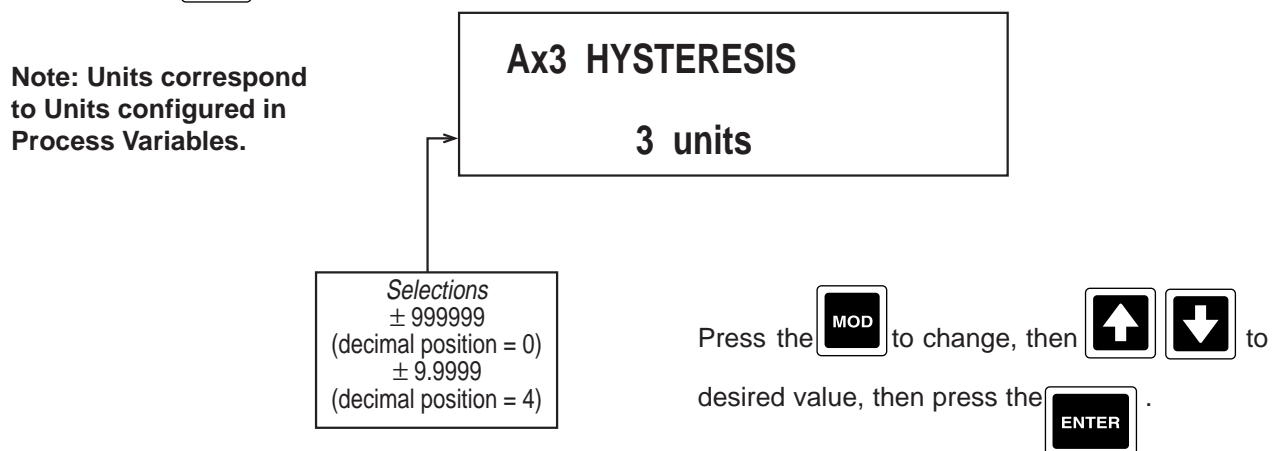





**NOTE: If RATE Alarm is selected, Hysteresis equals RATE in units/TIME BASE.**

23. Press the  to advance to the next parameter, **ALARM 4 TYPE**.



*Selections for recorder only*  
OFF  
PROCESS - HIGH  
PROCESS - LOW  
RATE - RISING  
RATE - FALLING

*Additional selections for use  
with controller option*  
BAND - WITHIN  
BAND - OUTSIDE  
DEVIATION - ABOVE  
DEVIATION - BELOW  
CONTROL LOOP OPEN\*





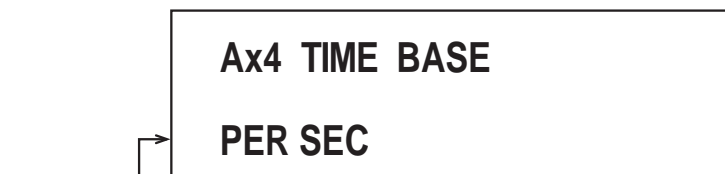

Press the  to change, then   to  
desired choice, then press the .

\* When CONTROL LOOP OPEN is selected for ALARM TYPE and NON PID is selected for CONTROL TYPE (CONTROLLERS section of CONFIGURATION), prompt LOOP ALARM TYPE will be displayed

24. Press the  to advance to the next parameter, **ALARM 4 TIME BASE** (only seen if Ax4 TYPE is RATE).



*Selections*  
PER SEC PER MIN  
PER HOUR PER DAY

Press the  to change, then  ,  
  to desired choice, then press  
the .

25. Press the  to advance to the next parameter, **ALARM 4 SAMPLE PERIOD** (only seen if Ax4 TYPE is RATE).

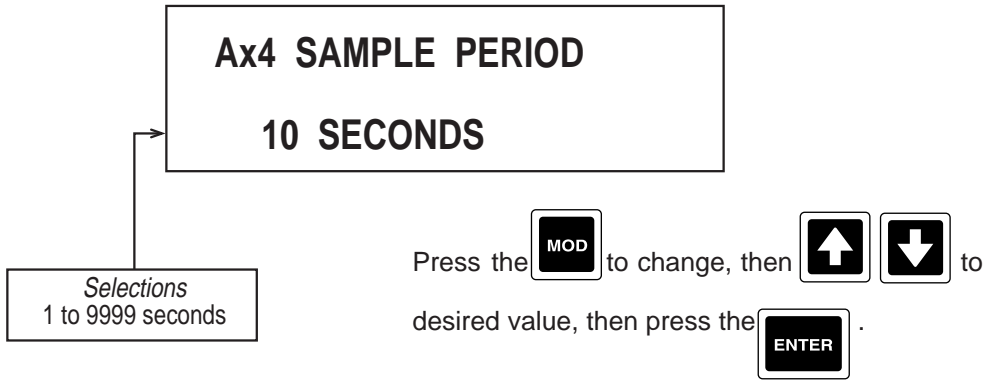

26. Press the  to advance to the next parameter, **ALARM 4 HYSTERESIS**.

**Note: Units correspond to Units configured in Process Variables.**

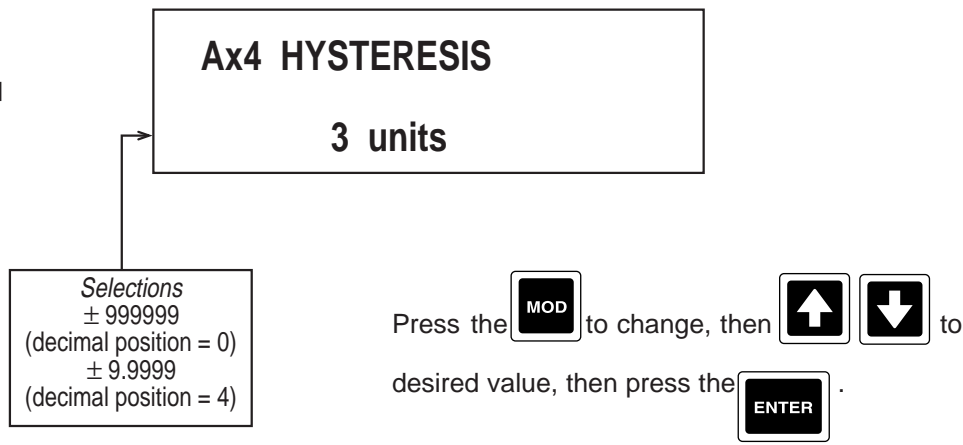

**NOTE: If RATE Alarm is selected, Hysteresis equals RATE in units/TIME BASE.**

27. Press the  to advance to the next parameter, **LOOP ALARM TIME** (only seen if CONTROL LOOP OPEN selected as ALARM TYPE and ON/OFF selected as CONTROL TYPE).

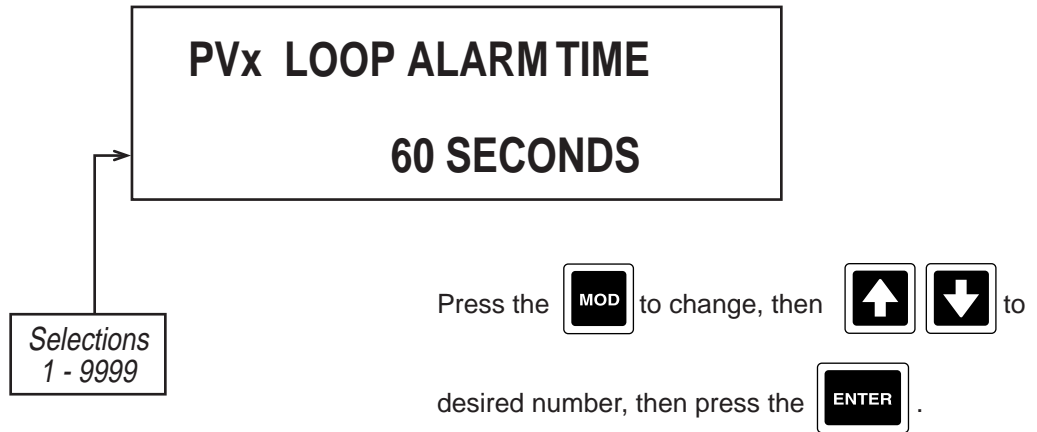

28. Press the  to advance to the next parameter, **ALARM INHIBIT** (only seen if an Alarm has been configured).

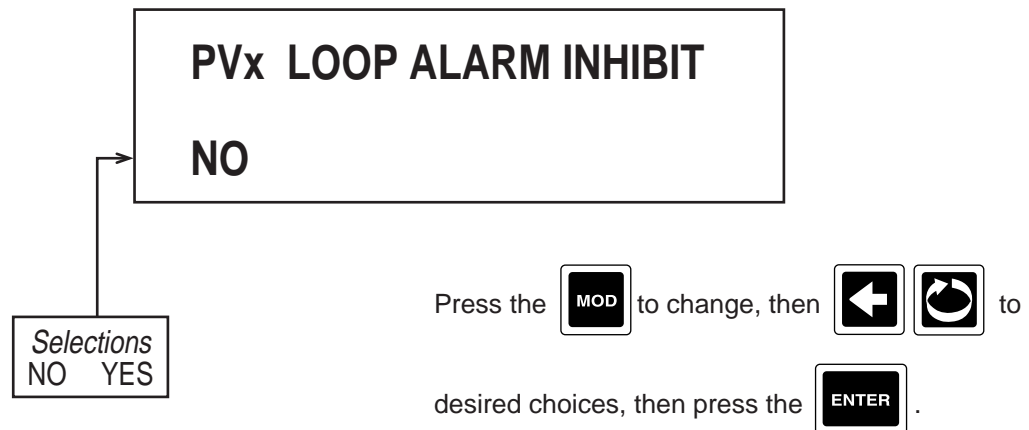

On power-up, an "alarm" condition may occur, based on the alarm value, the process variable value and, if appropriate to the alarm type, the (active) setpoint value. This would normally activate the alarm; however; if the pertinent alarm is inhibited, the alarm indication is suppressed and the alarm will remain inactive. This will prevail until the "alarm" condition returns to the "inactive" state, whereafter the alarm will operate normally.

29. Press the  and the display advances to the next process variable input to be programmed. Refer to the beginning of this section, page 4-32.

**4.1.6 RECORDERS**

Recorders defines values being recorded, tags, method, source of data and chart divisions and zoning.

In the Normal Display, press the  until **CONFIGURATION** is seen in the lower display line. If **PASSWORD** appears in the lower display line, the correct "password" will need to be entered before access to Configuration is allowed. If **CONFIGURATION** is not displayed, then Configuration has been disabled. Refer to Section 9, Enables and Passwords, for instructions to enable Configuration.

With **CONFIGURATION** in the display, press the , then the  until **RECORDERS** appears in the lower display line.

1. Press the  to display **RECORDER NUMBER**.

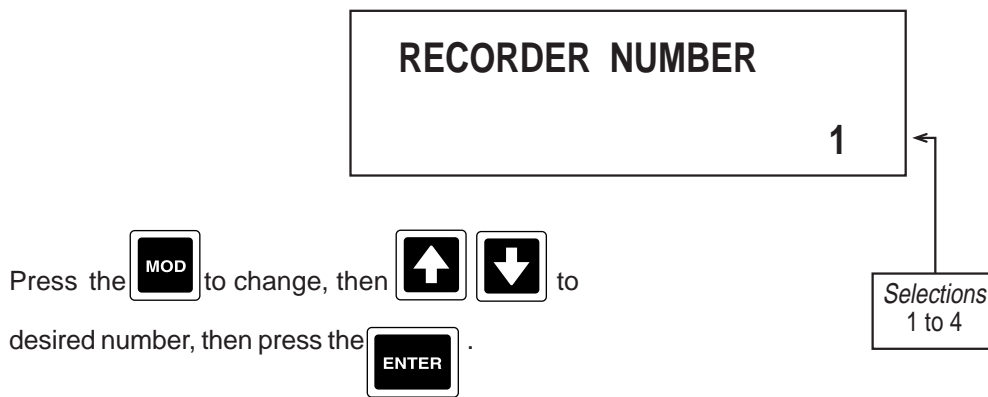

2. Press the  to advance to the next parameter, **COPY/INITIALIZE**.

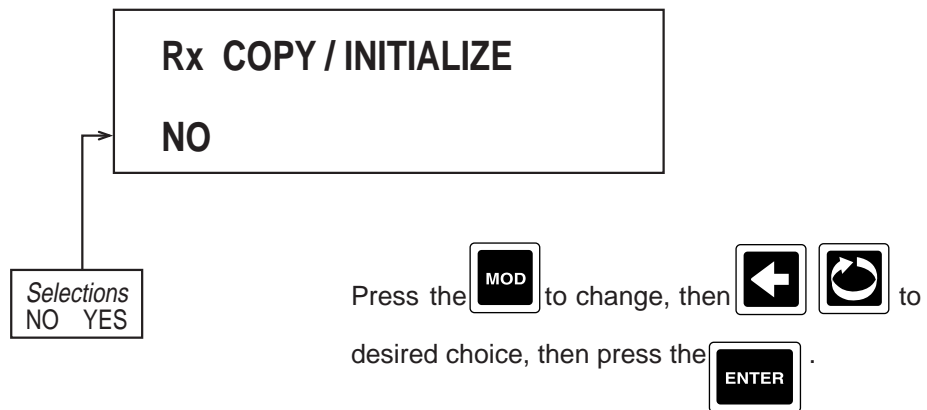

Choose YES if the parameters to be programmed are the same as another RECORDER already programmed.

If selection was NO, proceed to step 3.

If selection was YES:

**RECORDERS**

**Rs COPY FROM RECRDER**  
**(0 = INITIALIZE) X**

Press the   to change to the recorder number to be copied from.

*Recorder to be copied from*  
**0 = FACTORY DEFAULT**

3. Press the  to advance to the next parameter, **RECORDER TAG**.

**Rx RECORDER TAG**

*Selections*  
**Text**

Refer to Section 3.4.2 Changing Text, page 3-3 for instructions.



4. Press the  to advance to the next parameter, **VALUE TO RECORD**.

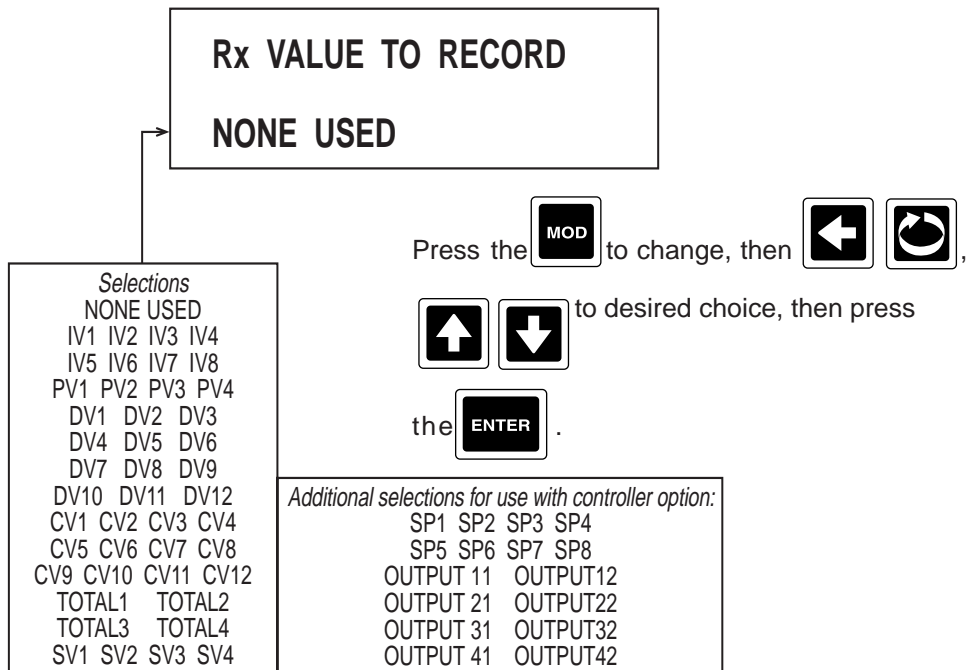

***If NONE USED was selected, no other prompts for Recorder X will be seen. Refer back to step 1, page 4-43.***

5. Press the  to advance to the next parameter, **PEN/COLOR**.

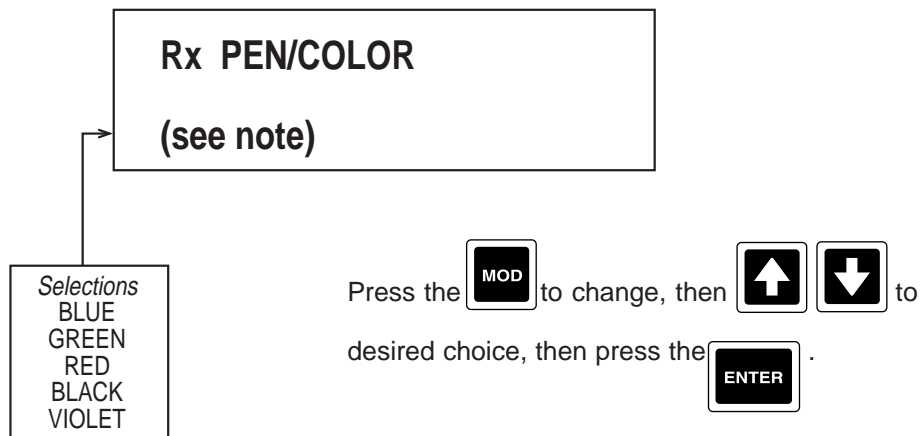

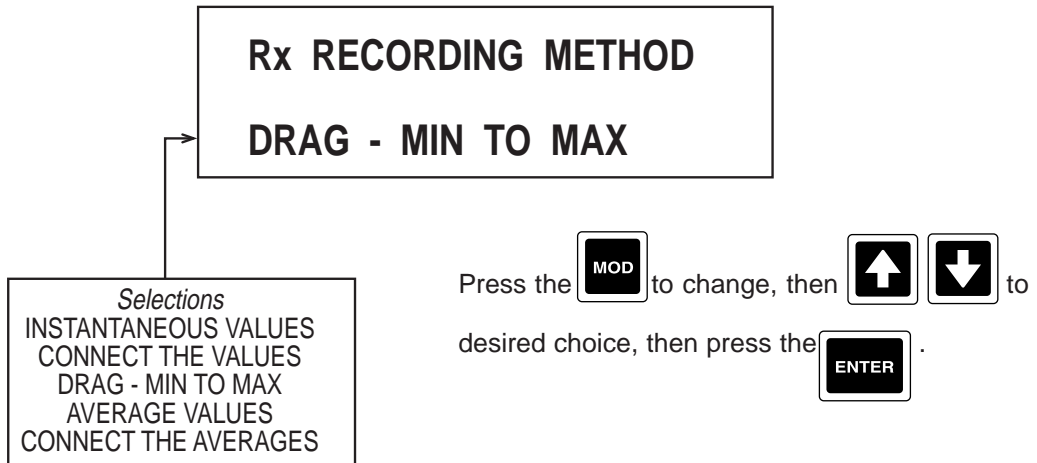

***NOTE: Default for Pen varies with Recorder Number: Pen 1 Red, Pen 2 Green, Pen 3 Blue, and Pen 4 Black or Violet (depending on color specified when ordered). Valid choice of color depends on number of colors specified when ordered. One color - Red, Two colors - Red, Green, Three colors - Red, Green, Blue or Four colors - Red, Green, Blue, Black or Violet.***

6. Press the  to advance to the next parameter, **RECORDING METHOD**.

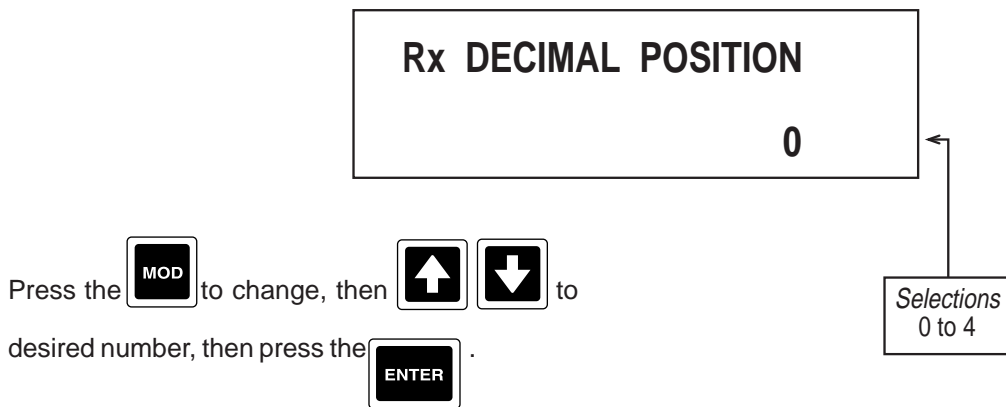

7. Press the  to advance to the next parameter, **DECIMAL POSITION**.





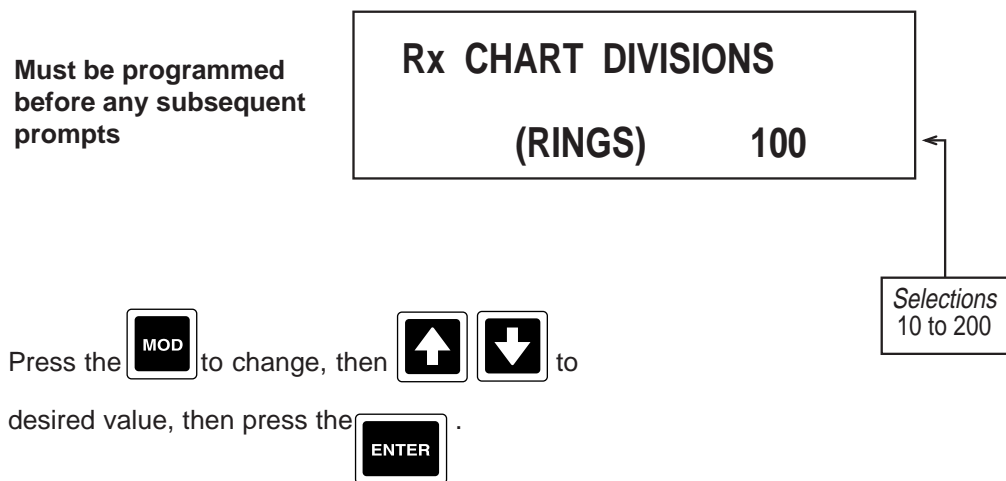

8. Press the  to advance to the next parameter, **CHART DIVISIONS**.



9. Press the  to advance to the next parameter, **ZONE 1 LOW**.







Rx ZONE 1 LOW  
DIVISION 0

Press the  to change, then   to desired value, then press the .

Selections  
0 to 200

10. Press the  to advance to the next parameter, **ZONE 1 HIGH**.





Rx ZONE 1 HIGH  
DIVISION 100

Press the  to change, then   to desired digit, then   to desired value, then press the .

Selections  
0 to 200

11. Press the  to advance to the next parameter, **SPAN 1 LOW**.

**Rx SPAN 1 LOW**  
**0 units**





Press the  to change, then   then to desired number, then press the  .

*Selections*  
± 999999  
(decimal position = 0)  
± 9.9999  
(decimal position = 4)

**Units correspond to Units configured in corresponding Value to Record parameter, previously selected.**

12. Press the  to advance to the next parameter, **SPAN 1 HIGH**.

**Rx SPAN 1 HIGH**  
**100 units**





Press the  to change, then   then to desired number, then press the  .

*Selections*  
± 999999  
(decimal position = 0)  
± 9.9999  
(decimal position = 4)

**Units correspond to Units configured in corresponding Value to Record parameter, previously selected.**

13. Press the  to advance to the next parameter, **SCALE 1 INTERVAL**.





**Rx SCALE 1 INTERVAL**  
**10 DIVISIONS**

Press the  to change, then   to desired number, then press the .

*Selections*  
0 to 200  
0 = NO SCALES

14. Press the  to advance to the next parameter, **ZONE 2 HIGH**.





**Rx ZONE 2 HIGH**  
**DIVISION 0**

Press the  to change, then   to desired number, then press the .

*Selections*  
0 to 200  
0 = SINGLE ZONE

15. Press the  to advance to the next parameter, **SPAN 2 HIGH** (Only if Zone 2 HIGH ≠ 0).

**Rx SPAN 2 HIGH**  
0 units





Press the  to change, then   then to desired number, then press the .

*Selections*  
± 999999  
(decimal position = 0)  
± 9.9999  
(decimal position = 4)

**Units correspond to Units configured in corresponding Value to Record parameter, previously selected.**

16. Press the  to advance to the next parameter, **SCALE 2 INTERVAL** (Only if Zone 2 HIGH ≠ 0).

**Rx SCALE 2 INTERVAL**  
10 DIVISIONS

Press the  to change, then   then to desired number, then press the .

*Selections*  
0 to 200  
0 = NO SCALES

17. Press the  to advance to the next parameter, **POSITION ON ERROR** (pen location in Chart Divisions on an ERROR condition).

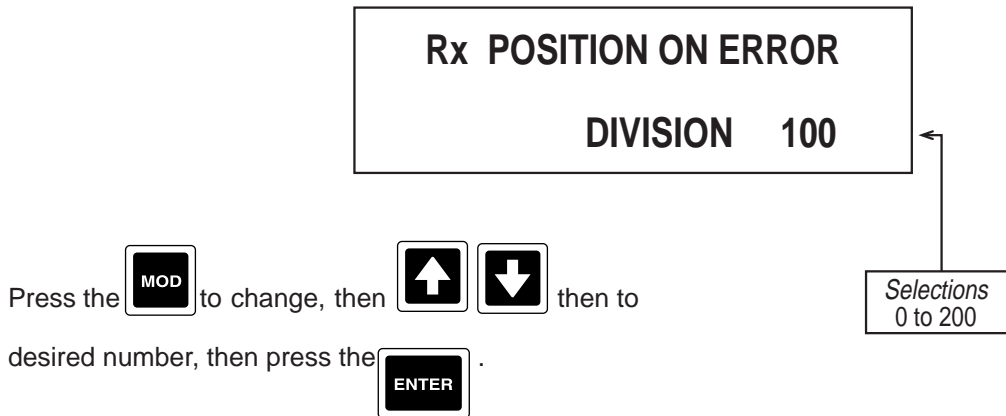

18. Press the  to advance to the next parameter, **FILTER**.

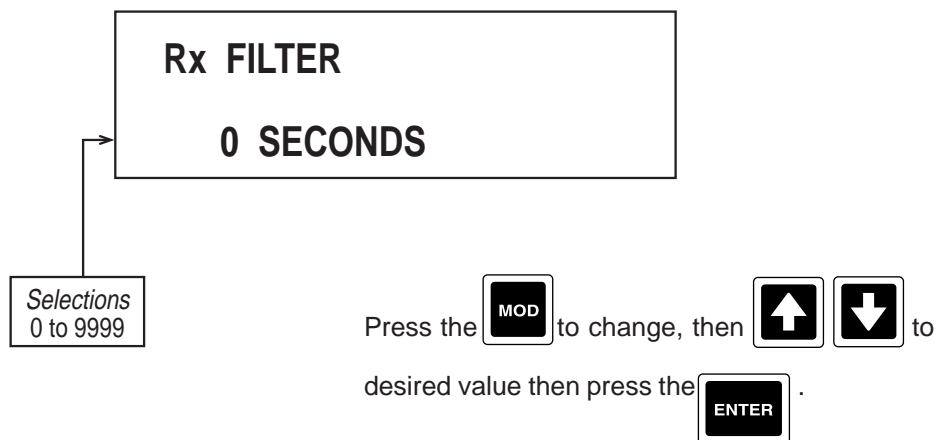

19. Press the  and the display advances to the next recorder variable to be programmed. Refer to the beginning of this section, page 4-43.

### 4.1.7 TOTALIZERS

Totalizers are seen only if TOTALIZATION was specified and present in the model number order matrix.





# TOTALIZERS

From the Normal Display, press  until **CONFIGURATION** is seen in the lower display line. If **PASS-WORD** appears in the lower display line, the correct "password" will need to be entered before access to Configuration is allowed. If **CONFIGURATION** is not displayed, then Configuration has been disabled. Refer to Section 9, Enables and Passwords, for instructions to enable Configuration.

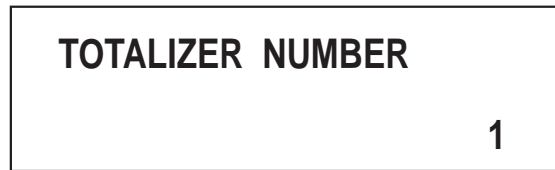
With **CONFIGURATION** in the display, press the , then the  until **TOTALIZERS** appears in the lower display line.

1. Press the  to display **TOTALIZER NUMBER**.





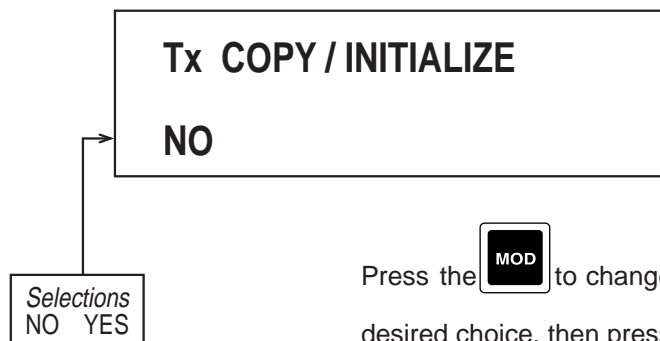

Press the  to change, then   to desired number, then press the .

Selections  
1 to 4

2. Press the  to advance to the next parameter, **COPY/INITIALIZE**.



Press the  to change, then   to desired choice, then press the .



Choose YES if the parameter to be programmed are the same as another TOTALIZER already programmed.

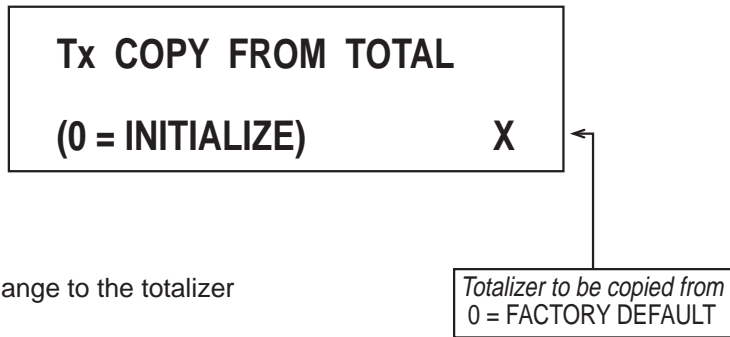

If selection was NO, proceed to step 3.

If selection was YES:



Press the   to change to the totalizer number to be copied from.

3. Press the  to advance to the next parameter, **DISPLAY TAG**.

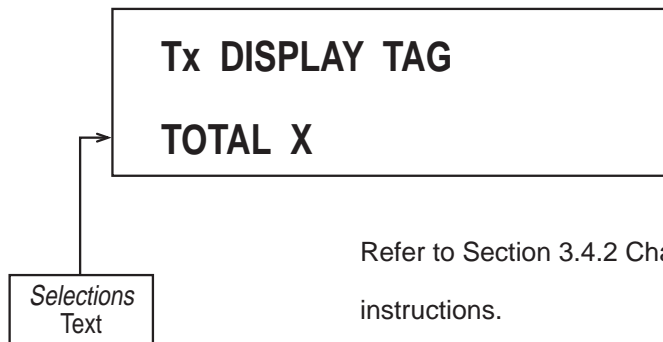

Refer to Section 3.4.2 Changing Text, page 3-3 for instructions.

4. Press the  to advance to the next parameter, **INPUT VALUE**.

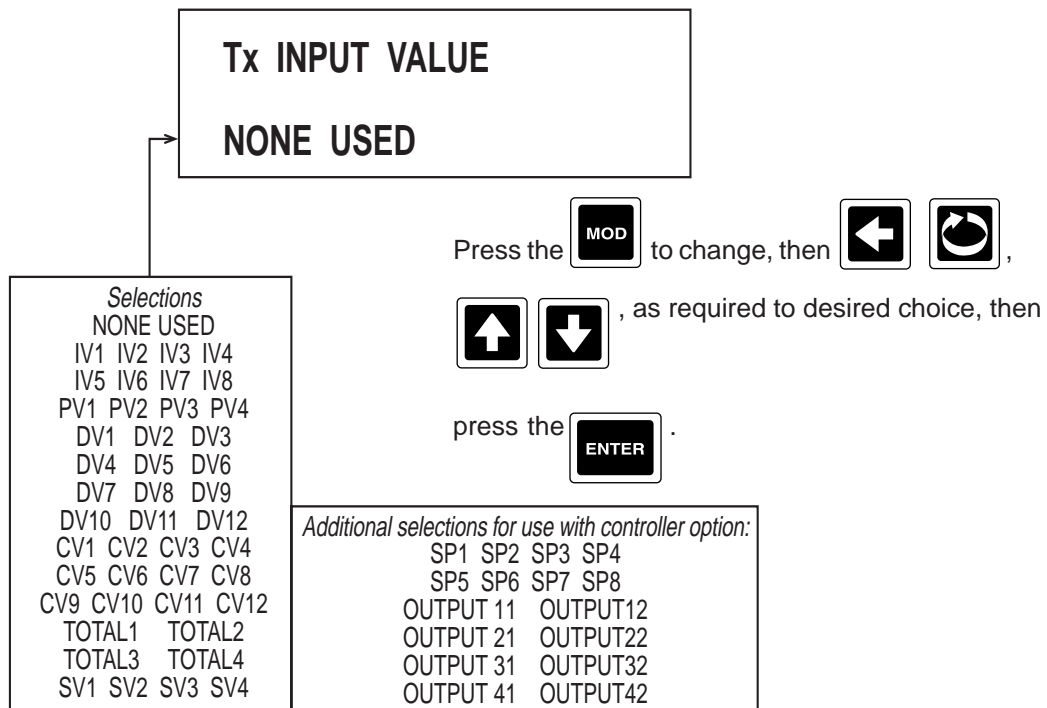



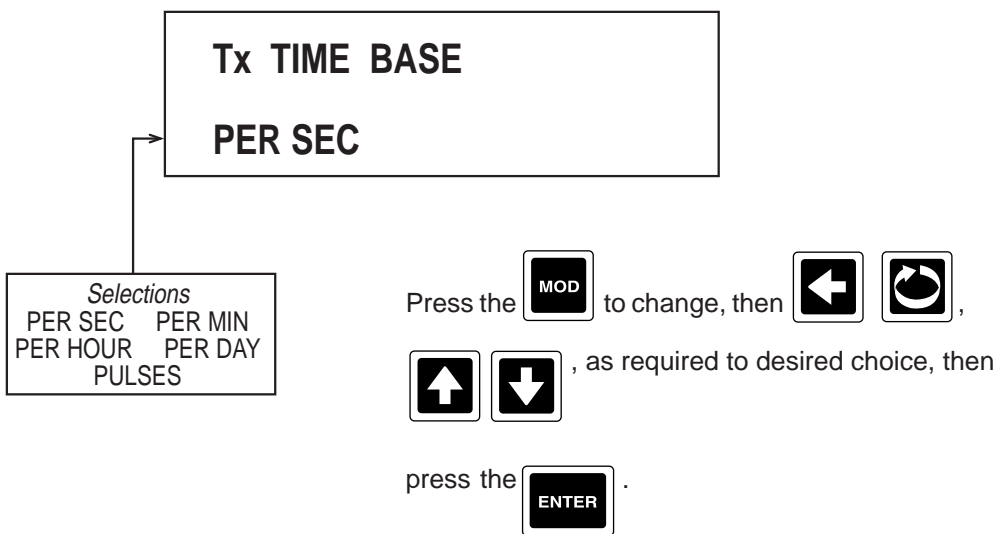

*If NONE USED was selected, no other prompts for Totalizer X will be seen. Refer back to step 1, page 4-52.*

5. Press the  to advance to the next parameter, **TIME BASE**.



6. Press the  to advance to the next parameter, **TOTAL IS FLOW**.

**Tx TOTAL IS FLOW**  
TIMES 1

Press the  to change, then   to desired choice, then press the .

*Selections*  
TIMES 1,000,000  
TIMES 100,000  
TIMES 10,000  
TIMES 1,000  
TIMES 100  
TIMES 10  
TIMES 1  
TIMES 0.1  
TIMES 0.01  
TIMES 0.001  
TIMES 0.0001

7. Press the  to advance to the next parameter, **DISPLAY OPTION**.





**Tx DISPLAY UNITS**  
GAL.

*Selections*  
Text

Refer to Section 3.4.2 Changing Text, page 3-3 for instructions.

8. Press the  to advance to the next parameter, **DECIMAL POSITION**.

**Tx DECIMAL POSITION**  
0

Press the  to change, then   to desired choice, then press the .

*Selections*  
0 to 4

9. Press the  to advance to the next parameter, **DISPLAY OPTION**.

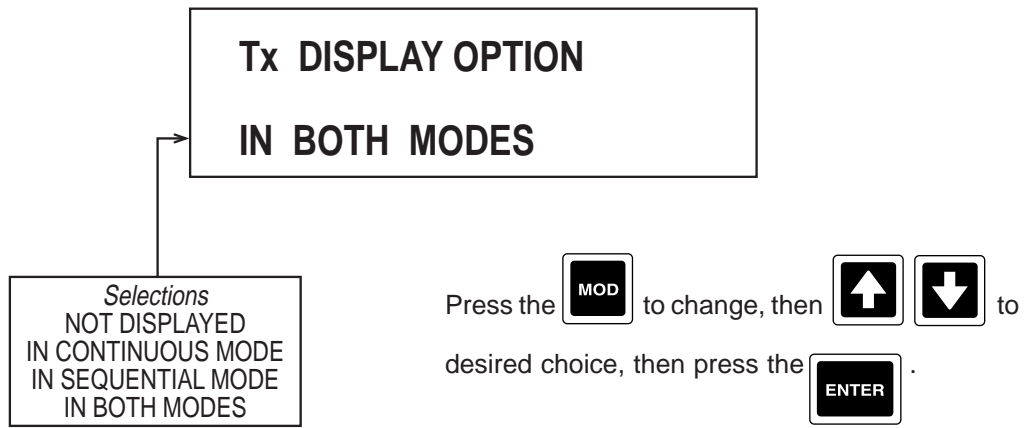

10. Press the  to advance to the next parameter, **DISPLAY FORMAT**.

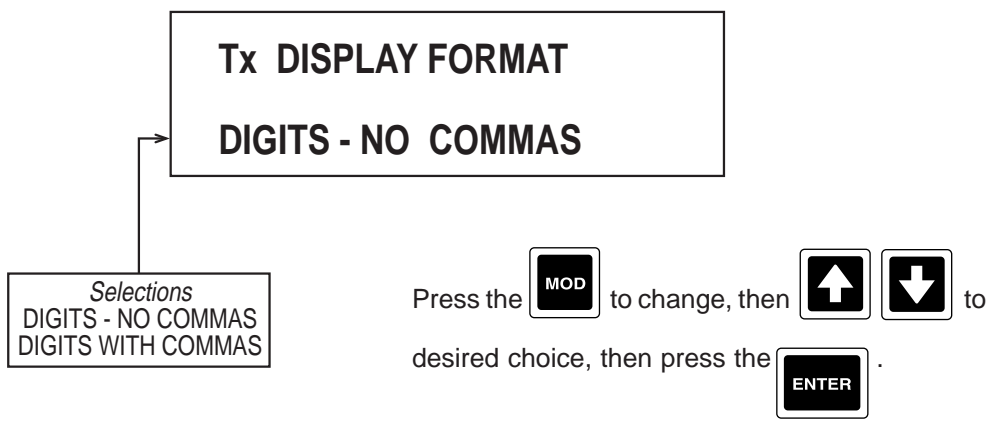

11. Press the  to advance to the next parameter, **TOTALIZER TYPE**.

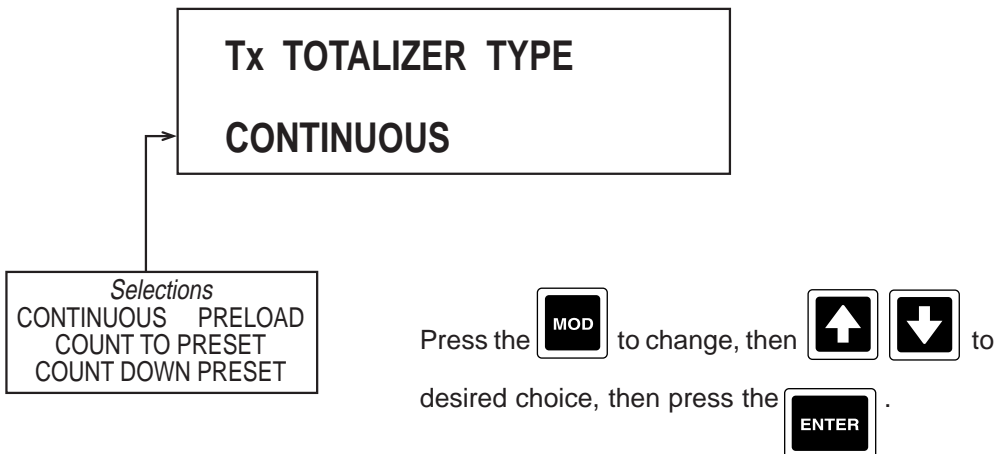

12. Press the  to advance to the next parameter, **TOTALIZER PRESET**.

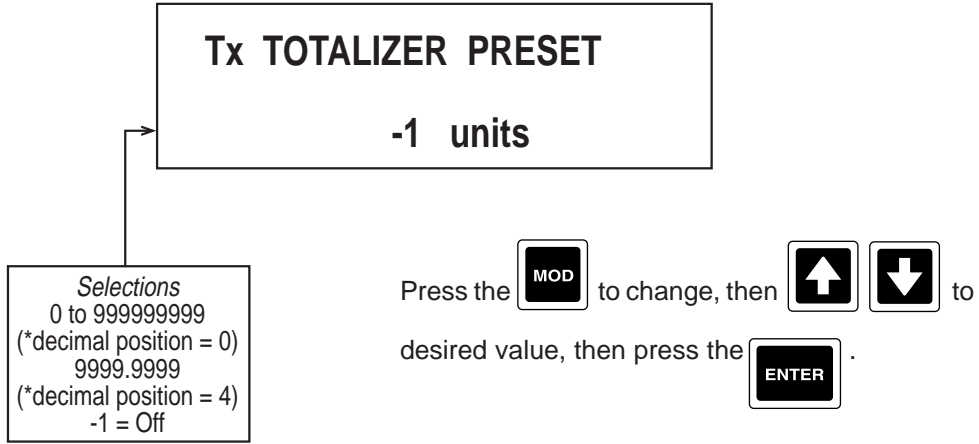

**Note: Units are that of TOTAL.**

**\* Total Decimal Position**

13. Press the  to advance to the next parameter, **LOW FLOW CUTOFF**.

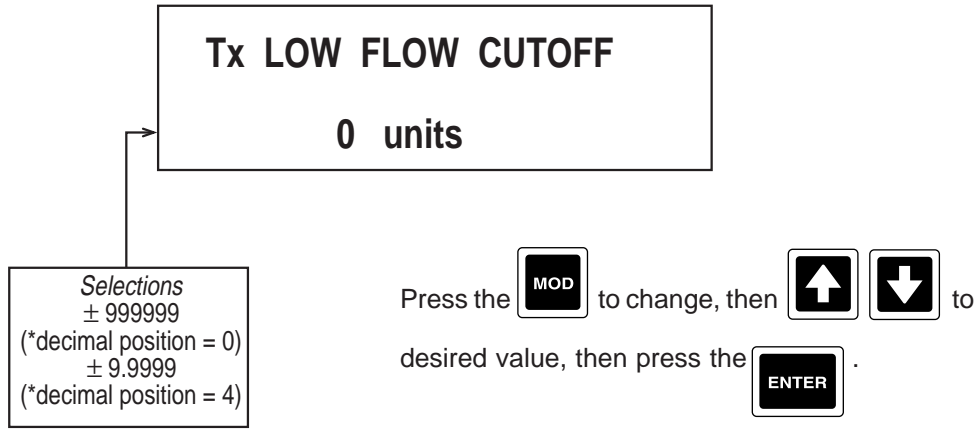



**Note: Units are that of INPUT (RATE). If no units were selected, the display will show - NONE -.**

**\*Input Decimal Position**

14. Press the  to advance to the next parameter, **RESET ACTUATOR**.

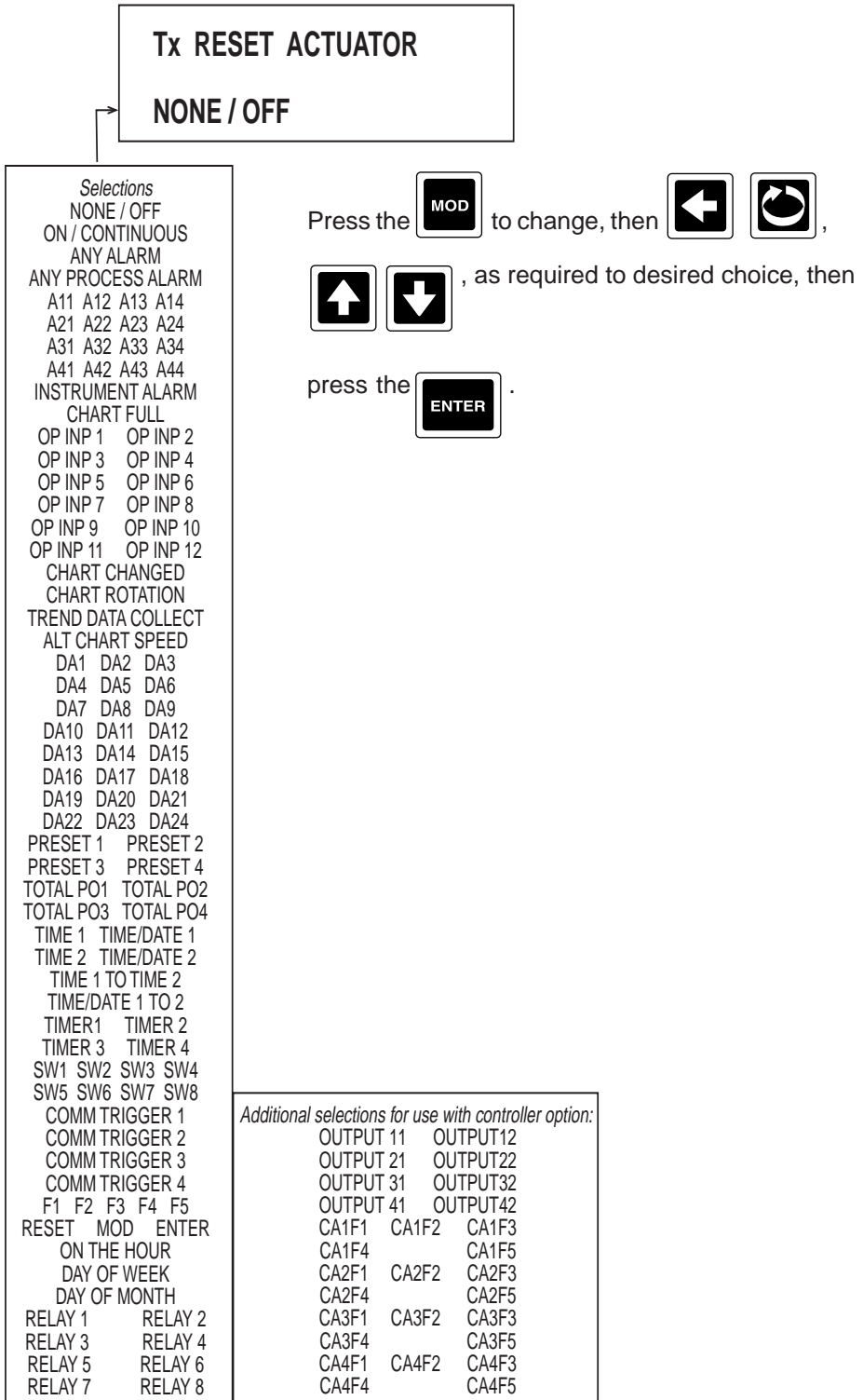





**TOTALIZERS**



15. Press the  to advance to the next parameter, **HOLD ACTUATOR**.

**Tx HOLD ACTUATOR**  
**NONE / OFF**

- Selections*  
 NONE / OFF  
 ON / CONTINUOUS  
 ANY ALARM  
 ANY PROCESS ALARM  
 A11 A12 A13 A14  
 A21 A22 A23 A24  
 A31 A32 A33 A34  
 A41 A42 A43 A44  
 INSTRUMENT ALARM  
 CHART FULL  
 OP INP 1 OP INP 2  
 OP INP 3 OP INP 4  
 OP INP 5 OP INP 6  
 OP INP 7 OP INP 8  
 OP INP 9 OP INP 10  
 OP INP 11 OP INP 12  
 CHART CHANGED  
 CHART ROTATION  
 TREND DATA COLLECT  
 ALT CHART SPEED  
 DA1 DA2 DA3  
 DA4 DA5 DA6  
 DA7 DA8 DA9  
 DA10 DA11 DA12  
 DA13 DA14 DA15  
 DA16 DA17 DA18  
 DA19 DA20 DA21  
 DA22 DA23 DA24  
 PRESET 1 PRESET 2  
 PRESET 3 PRESET 4  
 TOTAL PO1 TOTAL PO2  
 TOTAL PO3 TOTAL PO4  
 TIME 1 TIME/DATE 1  
 TIME 2 TIME/DATE 2  
 TIME 1 TO TIME 2  
 TIME/DATE 1 TO 2  
 TIMER1 TIMER 2  
 TIMER 3 TIMER 4  
 SW1 SW2 SW3 SW4  
 SW5 SW6 SW7 SW8  
 COMM TRIGGER 1  
 COMM TRIGGER 2  
 COMM TRIGGER 3  
 COMM TRIGGER 4  
 F1 F2 F3 F4 F5  
 RESET MOD ENTER  
 ON THE HOUR  
 DAY OF WEEK  
 DAY OF MONTH  
 RELAY 1 RELAY 2  
 RELAY 3 RELAY 4  
 RELAY 5 RELAY 6  
 RELAY 7 RELAY 8

Press the  to change, then  ,  
 , as required to desired choice, then  
 press the .

- Additional selections for use with controller option:*  
 OUTPUT 11 OUTPUT12  
 OUTPUT 21 OUTPUT22  
 OUTPUT 31 OUTPUT32  
 OUTPUT 41 OUTPUT42  
 CA1F1 CA1F2 CA1F3  
 CA1F4 CA1F5  
 CA2F1 CA2F2 CA2F3  
 CA2F4 CA2F5  
 CA3F1 CA3F2 CA3F3  
 CA3F4 CA3F5  
 CA4F1 CA4F2 CA4F3  
 CA4F4 CA4F5

16. Press the  to advance to the next parameter, **PULSED OUTPUT**.

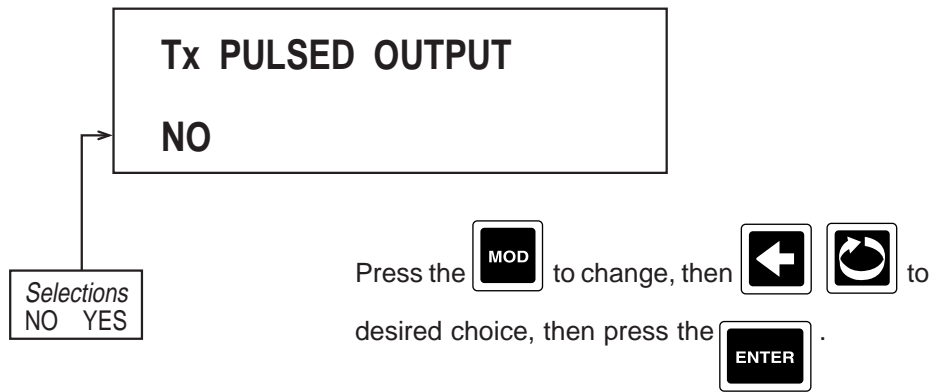

17. Press the  to advance to the next parameter, **PULSE EVERY** (only seen if PULSED OUTPUT select is YES).

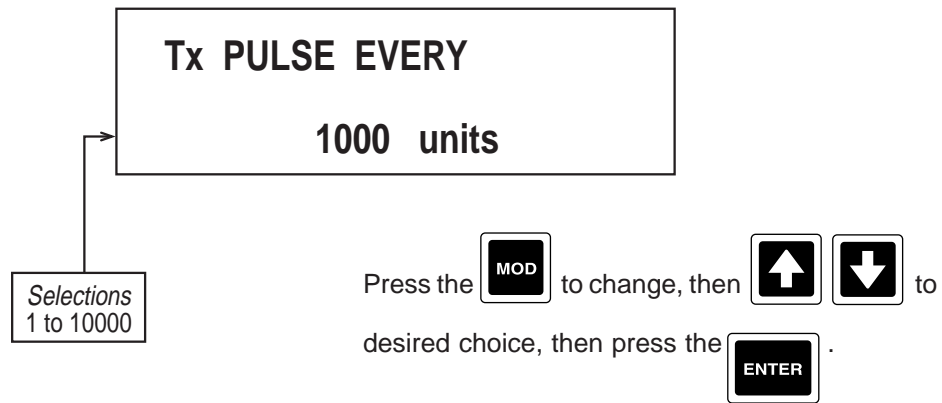

**Note: Units are that of TOTAL.**

18. Press the  and the display advances to the next totalizer to be programmed. Refer to the beginning of this section, page 4-52.



**4.1.8 TIMERS**

Timers are seen only if the MATH option was specified and present in the model number order matrix.

From the Normal Display, press the  until **CONFIGURATION** is seen in the lower display line. If **PASS-WORD** appears in the lower display line, the correct "password" will need to be entered before access to Configuration is allowed. If **CONFIGURATION** is not displayed, then Configuration has been disabled. Refer to Section 9, Enables and Passwords, for instructions to enable Configuration.

With **CONFIGURATION** in the display, press the , then the  until **TIMERS** appears in the lower display line.

1. Press the  to display **TIMER NUMBER**.

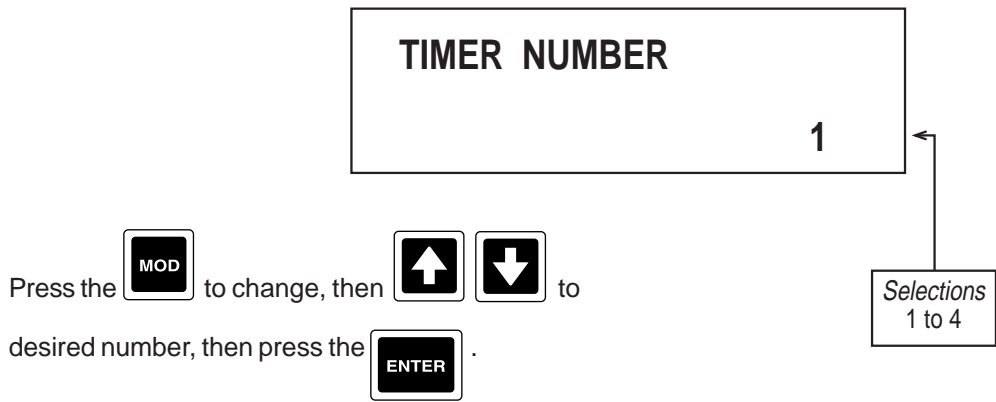

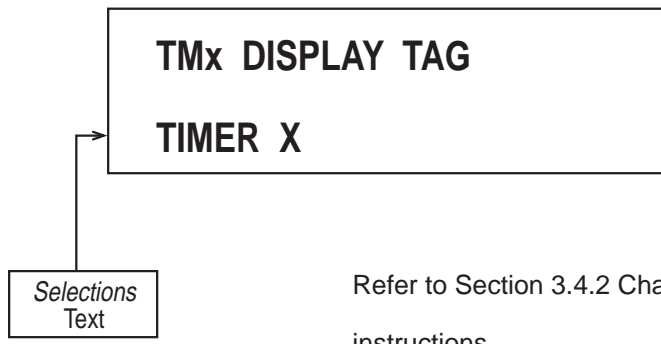

2. Press the  to advance to the next parameter, **DISPLAY TAG**.

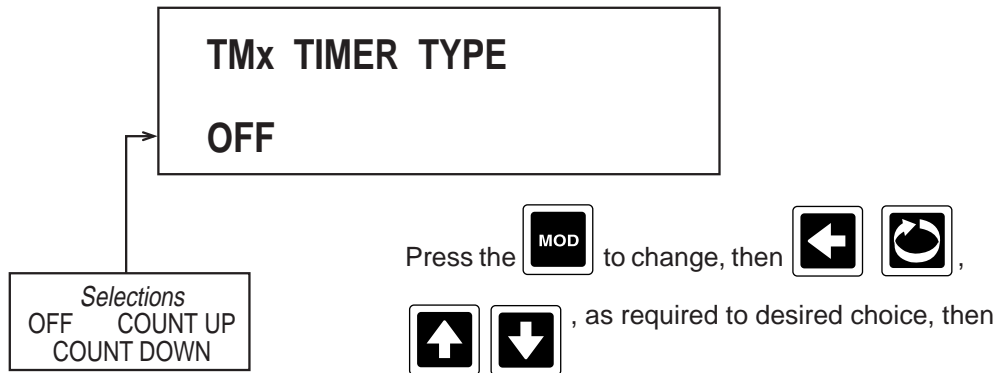

Refer to Section 3.4.2 Changing Text, page 3-3 for instructions.

3. Press the  to advance to the next parameter, **TIMER TYPE**.



*If OFF was selected, no other prompts for TIMER X will be seen, refer back to step 1, page 4-61.* press the .

4. Press the  to advance to the next parameter, **TIME FORMAT**.

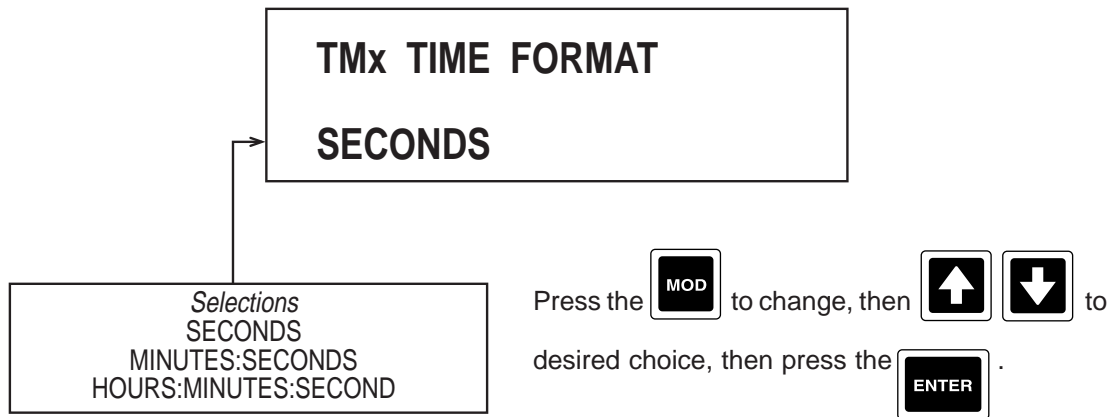

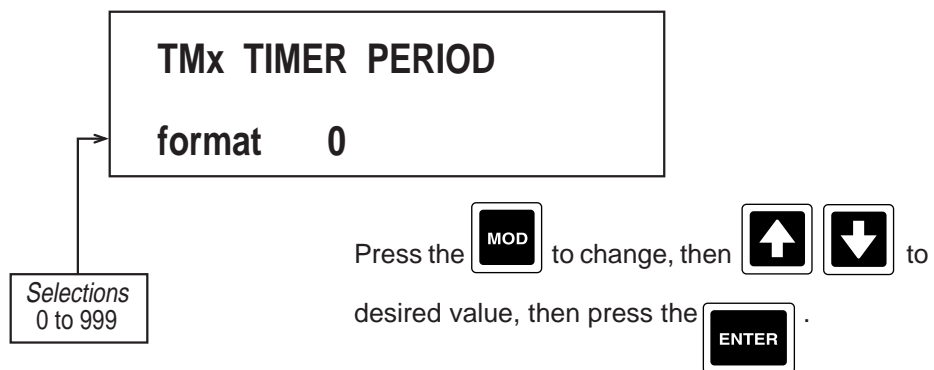

Format:  
 SSS seconds  
 MMM:SS Minutes/Seconds  
 HHH:MM:SS Hours/Minutes/Seconds

5. Press the  to advance to the next parameter, **TIMER PERIOD**, per selected TIME FORMAT.

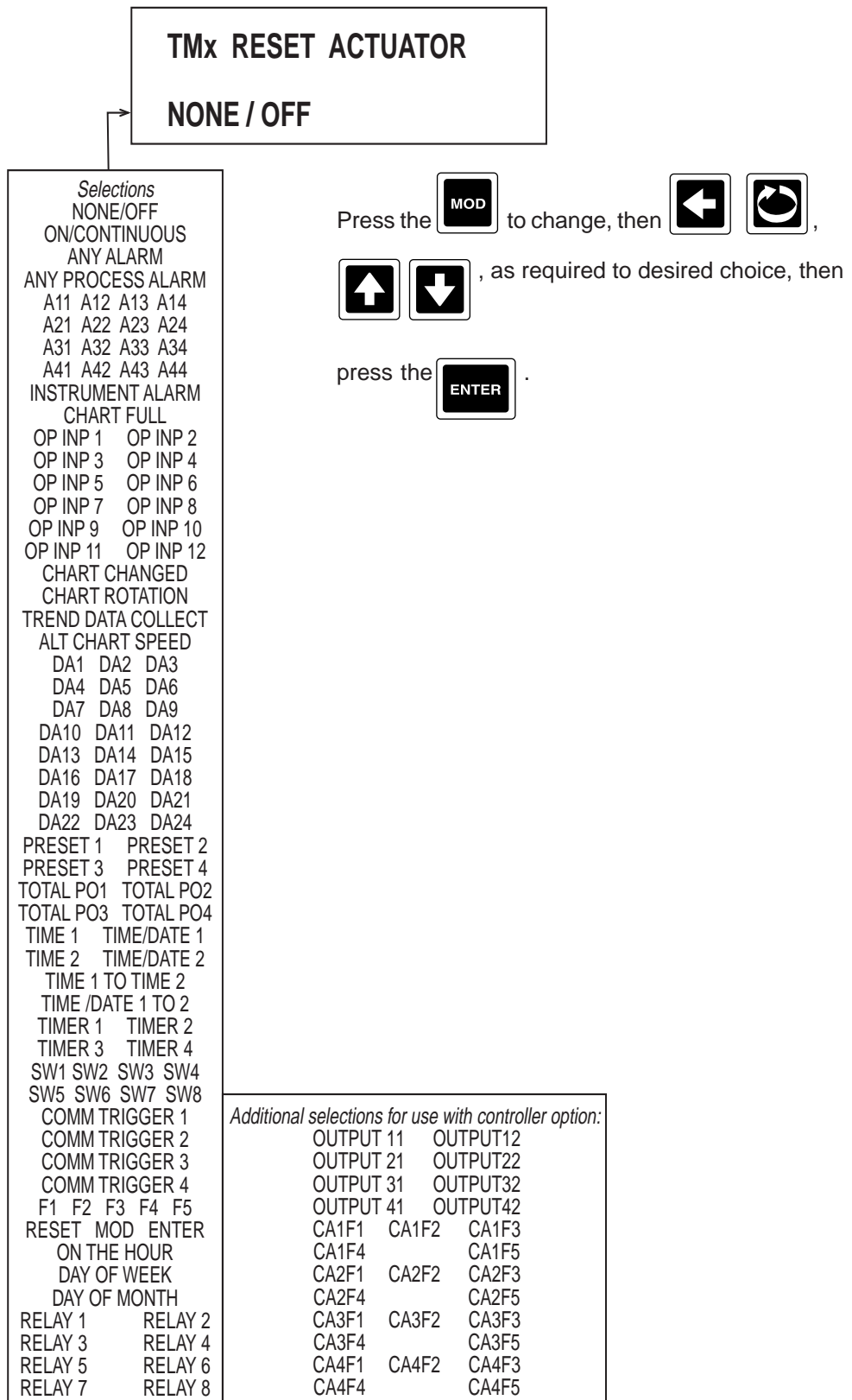

6. Press the  to advance to the next parameter, **RESET ACTUATOR**.



7. Press the  to advance to the next parameter, **DISPLAY OPTION**.

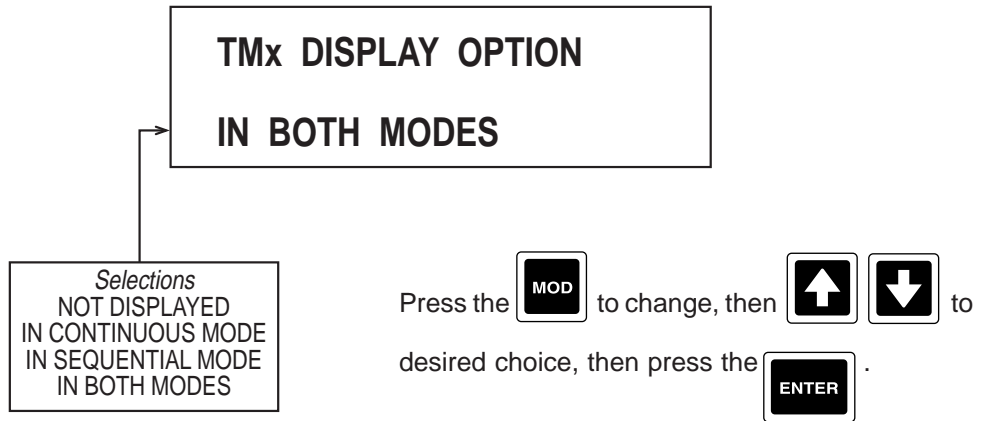

8. Press the  and the display advances to the next timer to be programmed. Refer to the beginning of this section, page 4-61.

#### 4.1.9 LEDES

In this section, each of the available 8 individual LEDs can be configured to operate on any of the available actuators.

From the Normal Display, press the  until **CONFIGURATION** is seen in the lower display line. If **PASS-WORD** appears in the lower display line, the correct "password" will need to be entered before access to Configuration is allowed. If **CONFIGURATION** is not displayed, then Configuration has been disabled. Refer to Section 9, Enables and Passwords, for instructions to enable Configuration.

With **CONFIGURATION** in the display, press the , then the  until **LEDES** appears in the lower display line.

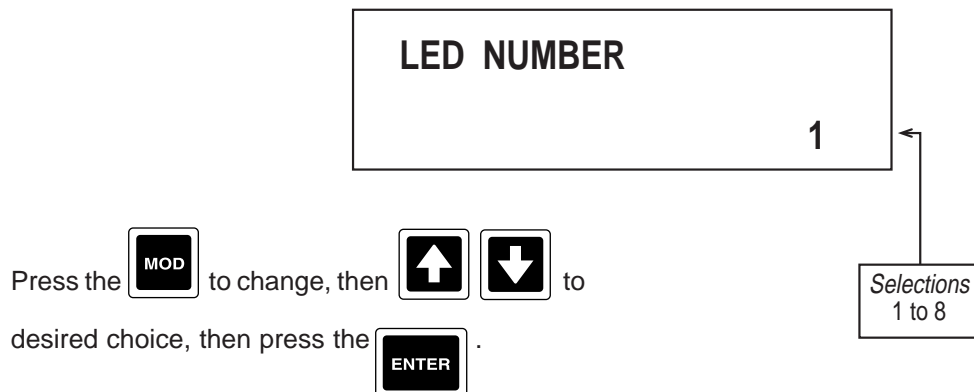

1. Press the  to display **LED NUMBER**.





2. Press the  to advance to the next parameter, **LED ACTUATOR**.

**LED x ACTUATOR**

**NONE / OFF**

Press the  to change, then  ,

 , as required to desired choice, then

press the .

*Selections*

NONE/OFF  
 ON/CONTINUOUS  
 ANY ALARM  
 ANY PROCESS ALARM  
 A11 A12 A13 A14  
 A21 A22 A23 A24  
 A31 A32 A33 A34  
 A41 A42 A43 A44  
 INSTRUMENT ALARM  
 CHART FULL  
 OP INP 1 OP INP 2  
 OP INP 3 OP INP 4  
 OP INP 5 OP INP 6  
 OP INP 7 OP INP 8  
 OP INP 9 OP INP 10  
 OP INP 11 OP INP 12  
 CHART CHANGED  
 CHART ROTATION  
 TREND DATA COLLECT  
 ALT CHART SPEED  
 DA1 DA2 DA3  
 DA4 DA5 DA6  
 DA7 DA8 DA9  
 DA10 DA11 DA12  
 DA13 DA14 DA15  
 DA16 DA17 DA18  
 DA19 DA20 DA21  
 DA22 DA23 DA24  
 PRESET 1 PRESET 2  
 PRESET 3 PRESET 4  
 TOTAL PO1 TOTAL PO2  
 TOTAL PO3 TOTAL PO4  
 TIME 1 TIME/DATE 1  
 TIME 2 TIME/DATE 2  
 TIME 1 TO TIME 2  
 TIME /DATE 1 TO 2  
 TIMER 1 TIMER 2  
 TIMER 3 TIMER 4  
 SW1 SW2 SW3 SW4  
 SW5 SW6 SW7 SW8  
 COMM TRIGGER 1  
 COMM TRIGGER 2  
 COMM TRIGGER 3  
 COMM TRIGGER 4  
 F1 F2 F3 F4 F5  
 RESET MOD ENTER  
 ON THE HOUR  
 DAY OF WEEK  
 DAY OF MONTH  
 RELAY 1 RELAY 2  
 RELAY 3 RELAY 4  
 RELAY 5 RELAY 6  
 RELAY 7 RELAY 8

*Additional selections for use with controller option:*

OUTPUT 11 OUTPUT12  
 OUTPUT 21 OUTPUT22  
 OUTPUT 31 OUTPUT32  
 OUTPUT 41 OUTPUT42  
 CA1F1 CA1F2 CA1F3  
 CA1F4 CA1F5  
 CA2F1 CA2F2 CA2F3  
 CA2F4 CA2F5  
 CA3F1 CA3F2 CA3F3  
 CA3F4 CA3F5  
 CA4F1 CA4F2 CA4F3  
 CA4F4 CA4F5

**LED S**

3. Press the  and the display advances to the next LED to be programmed. Refer to the beginning of this section, page 4-64.

#### 4.1.10 RELAYS

Relays only available when specified and present in the model number order matrix.

From the Normal Display, press the  until **CONFIGURATION** is seen in the lower display line. If **PASS-WORDS** appears in the lower display line, the correct "password" will need to be entered before access to Configuration is allowed. If **CONFIGURATION** is not displayed, then Configuration has been disabled. Refer to Section 9, Enables and Passwords, for instructions to enable Configuration.

With **CONFIGURATION** in the display, press the , then the  until **RELAYS** appears in the lower display line.

1. Press the  to display **RELAY NUMBER**.

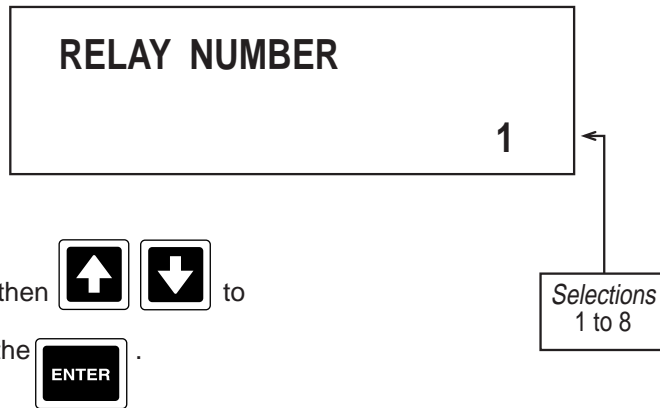

2. Press the  to advance to the next parameter, **RELAY USAGE**.

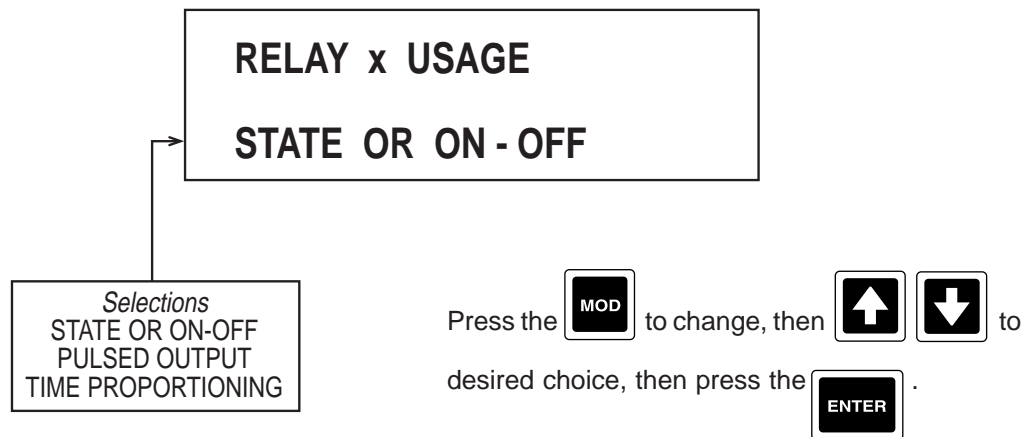









3. Press the  to advance to the next parameter, **RELAY ACTUATOR** (only available if RELAY USAGE selected was STATE OR ON-OFF or PULSED OUTPUT).

**RELAY x ACTUATOR**  
**NONE / OFF**

- Selections*  
 NONE/OFF  
 ON/CONTINUOUS  
 ANY ALARM  
 ANY PROCESS ALARM  
 A11 A12 A13 A14  
 A21 A22 A23 A24  
 A31 A32 A33 A34  
 A41 A42 A43 A44  
 INSTRUMENT ALARM  
 CHART FULL  
 OP INP 1 OP INP 2  
 OP INP 3 OP INP 4  
 OP INP 5 OP INP 6  
 OP INP 7 OP INP 8  
 OP INP 9 OP INP 10  
 OP INP 11 OP INP 12  
 CHART CHANGED  
 CHART ROTATION  
 TREND DATA COLLECT  
 ALT CHART SPEED  
 DA1 DA2 DA3  
 DA4 DA5 DA6  
 DA7 DA8 DA9  
 DA10 DA11 DA12  
 DA13 DA14 DA15  
 DA16 DA17 DA18  
 DA19 DA20 DA21  
 DA22 DA23 DA24  
 PRESET 1 PRESET 2  
 PRESET 3 PRESET 4  
 TOTAL PO1 TOTAL PO2  
 TOTAL PO3 TOTAL PO4  
 TIME 1 TIME/DATE 1  
 TIME 2 TIME/DATE 2  
 TIME 1 TO TIME 2  
 TIME /DATE 1 TO 2  
 TIMER 1 TIMER 2  
 TIMER 3 TIMER 4  
 SW1 SW2 SW3 SW4  
 SW5 SW6 SW7 SW8  
 COMM TRIGGER 1  
 COMM TRIGGER 2  
 COMM TRIGGER 3  
 COMM TRIGGER 4  
 F1 F2 F3 F4 F5  
 RESET MOD ENTER  
 ON THE HOUR  
 DAY OF WEEK  
 DAY OF MONTH  
 RELAY 1 RELAY 2  
 RELAY 3 RELAY 4  
 RELAY 5 RELAY 6  
 RELAY 7 RELAY 8

Press the  to change, then  ,  
 , as required to desired choice, then  
 press the .

- Additional selections for use with controller option:*  
 OUTPUT 11 OUTPUT12  
 OUTPUT 21 OUTPUT22  
 OUTPUT 31 OUTPUT32  
 OUTPUT 41 OUTPUT42  
 CA1F1 CA1F2 CA1F3  
 CA1F4 CA1F5  
 CA2F1 CA2F2 CA2F3  
 CA2F4 CA2F5  
 CA3F1 CA3F2 CA3F3  
 CA3F4 CA3F5  
 CA4F1 CA4F2 CA4F3  
 CA4F4 CA4F5

# RELAYS

4. Press the  to advance to the next parameter, **RELAY T.P. VALUE** (only seen if RELAY USAGE selected was TIME PROPORTIONING).

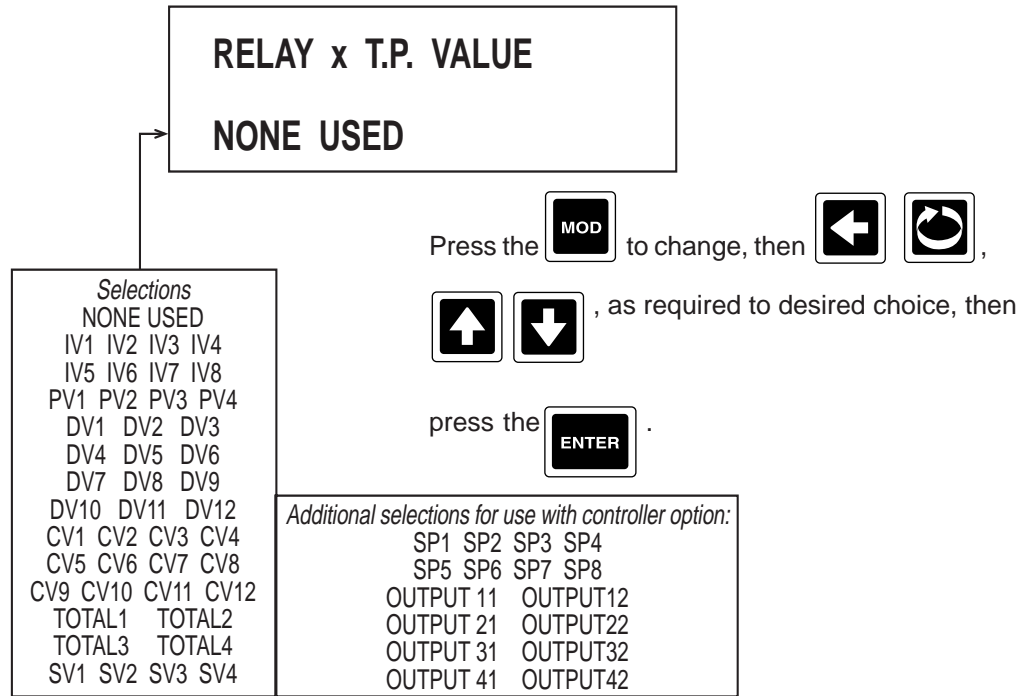

5. Press the  to advance to the next parameter, **CYCLE TIME** (only seen if RELAY USAGE selected is TIME PROPORTIONING).

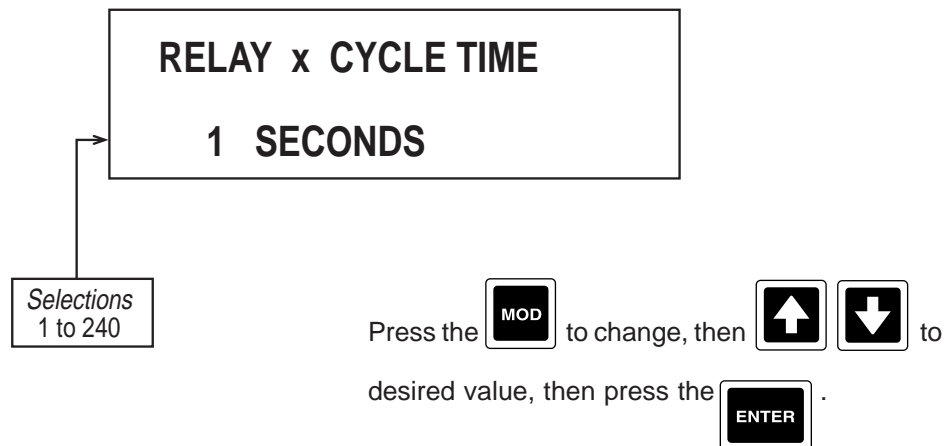

6. Press the  and the display advances to the next relay to be programmed. Refer to the beginning of this section, page 4-66.



**4.1.11 CURRENT OUTPUTS**

Only seen if current outputs has been specified and present in the model number order matrix.

From the Normal Display, press the  until **CONFIGURATION** is seen in the lower display line. If **PASS-WORD** appears in the lower display line, the correct "password" will need to be entered before access to Configuration is allowed. If **CONFIGURATION** is not displayed, then Configuration has been disabled. Refer to Section 9, Enables and Passwords, for instructions to enable Configuration.

With **CONFIGURATION** in the display, press the , then the  until **CURRENT OUTPUTS** appears in the lower display line.

1. Press the  to display **CURRENT OUTPUT**.

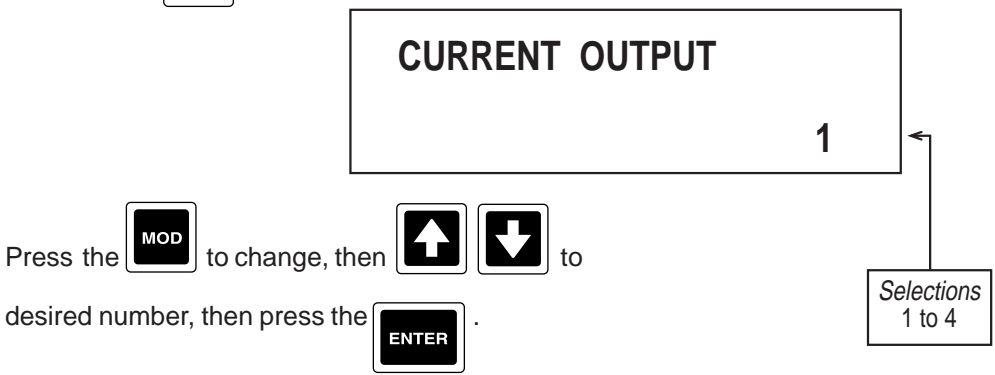

2. Press the  to advance to the next parameter, **SOURCE**.

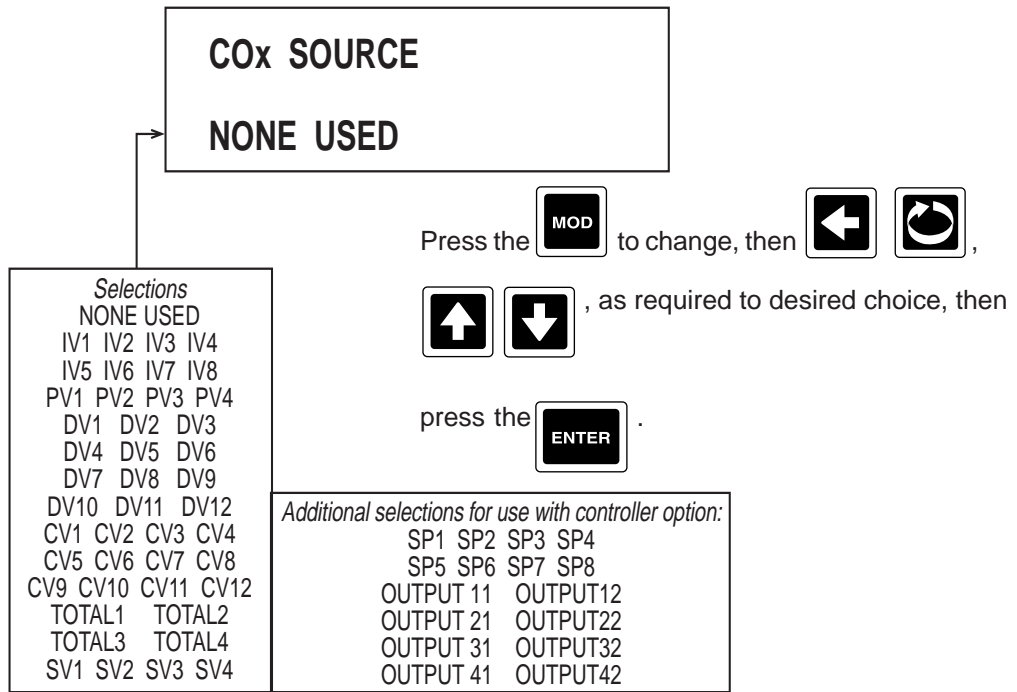



**If NONE USED was selected, no other prompts for CURRENT OUTPUT X will be displayed, refer to step 1 above.**

**CURRENT OUTPUTS**

3. Press the  to advance to the next parameter, **RANGE LOW**.

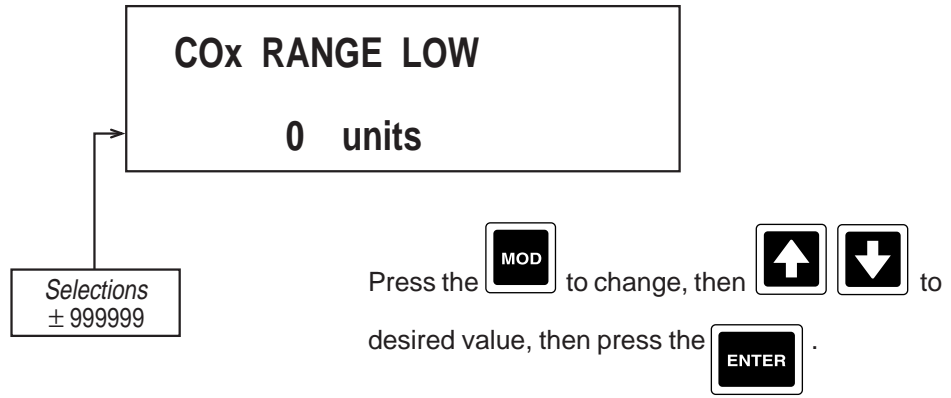
Units correspond to Units configured in corresponding CO Source parameter previously selected.



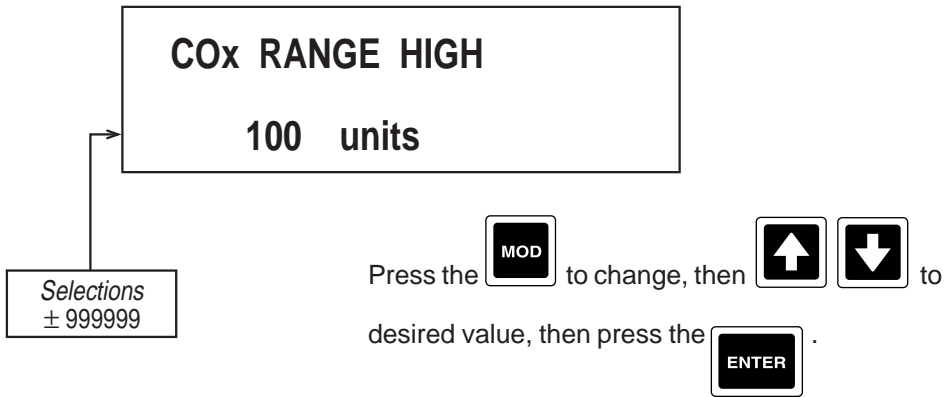

4. Press the  to advance to the next parameter, **RANGE HIGH**.

Units correspond to Units configured in corresponding CO Source parameter previously selected.

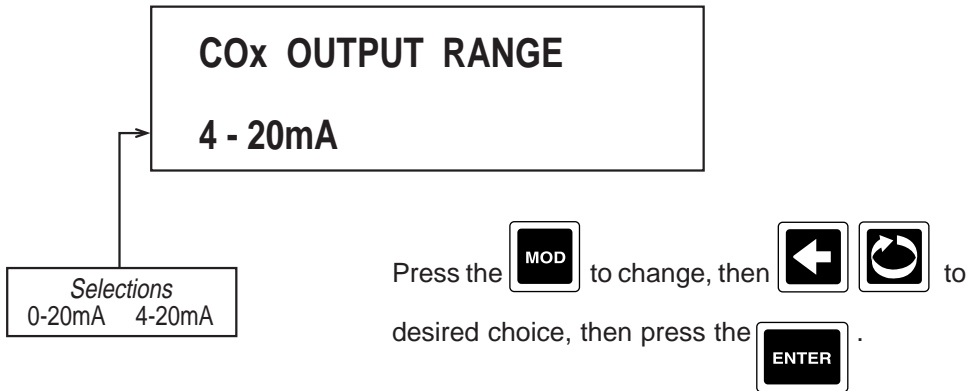

5. Press the  to advance to the next parameter, **OUTPUT RANGE**.



6. Press the  to advance to the next parameter, **OUTPUT ON ERROR**.

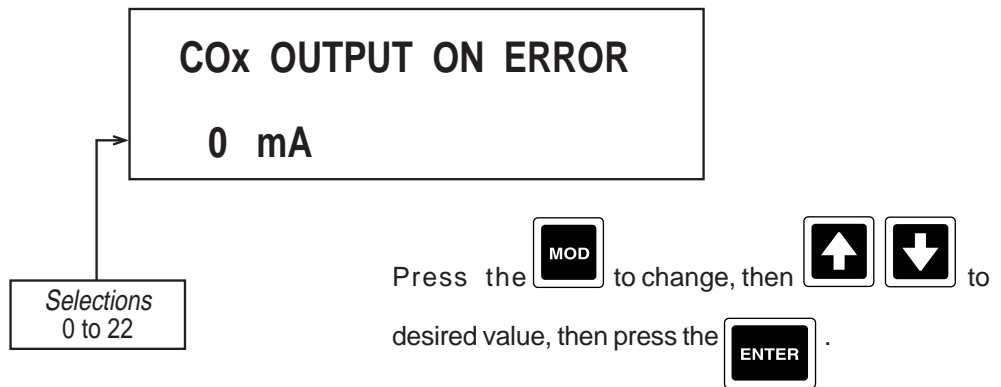

7. Press the  and the display advances to the next current output to be programmed. Refer to the beginning of this section, page 4-69.

#### 4.1.12 INSTRUMENT SETTINGS

Instrument Settings define instrument tag, display option and date/time format.

From the Normal Display, press the  until **CONFIGURATION** is seen in the lower display line. If **PASS-WORD** appears in the lower display line, the correct "password" will need to be entered before access to Configuration is allowed. If **CONFIGURATION** is not displayed, then Configuration has been disabled. Refer to Section 9, Enables and Passwords, for instructions to enable Configuration.

With **CONFIGURATION** in the display, press the , then the  until **INSTRUMENT SETTINGS** appears in the lower display line.



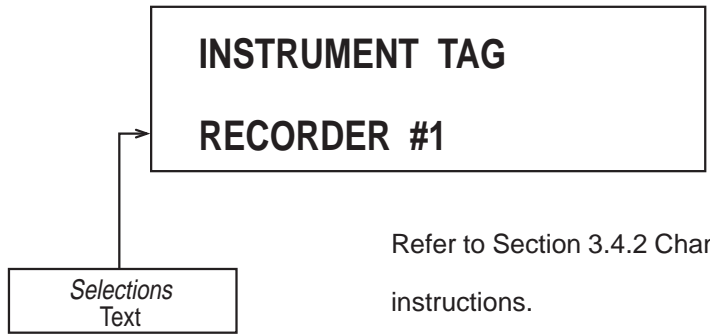

1. Press the  to display **INSTRUMENT TAG**.

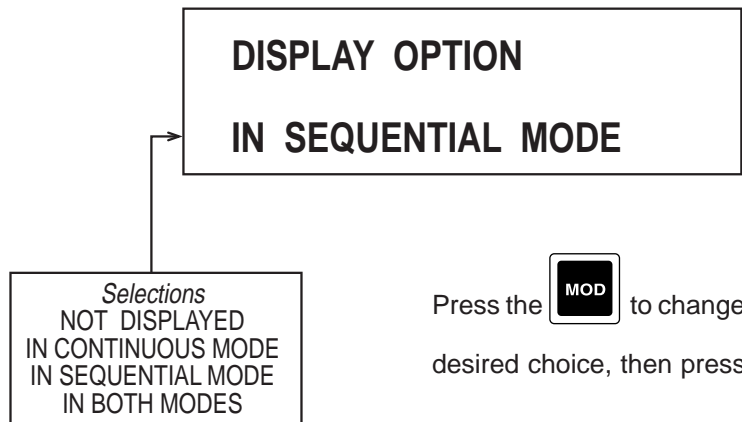

Refer to Section 3.4.2 Changing Text, page 3-3 for instructions.

2. Press the  to advance to the next parameters, **DISPLAY OPTION**.







Press the  to change, then   to desired choice, then press the .

3. Press the  to advance to the next parameter, **INSTR. ON ACTUATOR**.

**INSTR. ON ACTUATOR**

**ON / CONTINUOUS**

Press the  to change, then  ,

 , as required to desired choice, then

press the .

*Selections*

NONE/OFF  
 ON/CONTINUOUS  
 ANY ALARM  
 ANY PROCESS ALARM  
 A11 A12 A13 A14  
 A21 A22 A23 A24  
 A31 A32 A33 A34  
 A41 A42 A43 A44  
 INSTRUMENT ALARM  
 CHART FULL  
 OP INP 1 OP INP 2  
 OP INP 3 OP INP 4  
 OP INP 5 OP INP 6  
 OP INP 7 OP INP 8  
 OP INP 9 OP INP 10  
 OP INP 11 OP INP 12  
 CHART CHANGED  
 CHART ROTATION  
 TREND DATA COLLECT  
 ALT CHART SPEED  
 DA1 DA2 DA3  
 DA4 DA5 DA6  
 DA7 DA8 DA9  
 DA10 DA11 DA12  
 DA13 DA14 DA15  
 DA16 DA17 DA18  
 DA19 DA20 DA21  
 DA22 DA23 DA24  
 PRESET 1 PRESET 2  
 PRESET 3 PRESET 4  
 TOTAL PO1 TOTAL PO2  
 TOTAL PO3 TOTAL PO4  
 TIME 1 TIME/DATE 1  
 TIME 2 TIME/DATE 2  
 TIME 1 TO TIME 2  
 TIME /DATE 1 TO 2  
 TIMER 1 TIMER 2  
 TIMER 3 TIMER 4  
 SW1 SW2 SW3 SW4  
 SW5 SW6 SW7 SW8  
 COMM TRIGGER 1  
 COMM TRIGGER 2  
 COMM TRIGGER 3  
 COMM TRIGGER 4  
 F1 F2 F3 F4 F5  
 RESET MOD ENTER  
 ON THE HOUR  
 DAY OF WEEK  
 DAY OF MONTH  
 RELAY 1 RELAY 2  
 RELAY 3 RELAY 4  
 RELAY 5 RELAY 6  
 RELAY 7 RELAY 8



*Additional selections for use with controller option:*



OUTPUT 11 OUTPUT12  
 OUTPUT 21 OUTPUT22  
 OUTPUT 31 OUTPUT32  
 OUTPUT 41 OUTPUT42  
 CA1F1 CA1F2 CA1F3  
 CA1F4 CA1F5  
 CA2F1 CA2F2 CA2F3  
 CA2F4 CA2F5  
 CA3F1 CA3F2 CA3F3  
 CA3F4 CA3F5  
 CA4F1 CA4F2 CA4F3  
 CA4F4 CA4F5

4. Press the  to advance to the next parameter, **ALARMING ON ACTUATOR**.

**ALARMING ON ACTUATOR**  
**ON / CONTINUOUS**

- Selections*  
 NONE/OFF  
 ON/CONTINUOUS  
 ANY ALARM  
 ANY PROCESS ALARM  
 A11 A12 A13 A14  
 A21 A22 A23 A24  
 A31 A32 A33 A34  
 A41 A42 A43 A44  
 INSTRUMENT ALARM  
 CHART FULL  
 OP INP 1 OP INP 2  
 OP INP 3 OP INP 4  
 OP INP 5 OP INP 6  
 OP INP 7 OP INP 8  
 OP INP 9 OP INP 10  
 OP INP 11 OP INP 12  
 CHART CHANGED  
 CHART ROTATION  
 TREND DATA COLLECT  
 ALT CHART SPEED  
 DA1 DA2 DA3  
 DA4 DA5 DA6  
 DA7 DA8 DA9  
 DA10 DA11 DA12  
 DA13 DA14 DA15  
 DA16 DA17 DA18  
 DA19 DA20 DA21  
 DA22 DA23 DA24  
 PRESET 1 PRESET 2  
 PRESET 3 PRESET 4  
 TOTAL PO1 TOTAL PO2  
 TOTAL PO3 TOTAL PO4  
 TIME 1 TIME/DATE 1  
 TIME 2 TIME/DATE 2  
 TIME 1 TO TIME 2  
 TIME /DATE 1 TO 2  
 TIMER 1 TIMER 2  
 TIMER 3 TIMER 4  
 SW1 SW2 SW3 SW4  
 SW5 SW6 SW7 SW8  
 COMM TRIGGER 1  
 COMM TRIGGER 2  
 COMM TRIGGER 3  
 COMM TRIGGER 4  
 F1 F2 F3 F4 F5  
 RESET MOD ENTER  
 ON THE HOUR  
 DAY OF WEEK  
 DAY OF MONTH  
 RELAY 1 RELAY 2  
 RELAY 3 RELAY 4  
 RELAY 5 RELAY 6  
 RELAY 7 RELAY 8

Press the  to change, then  ,

  as required to desired choice, then







press the .

- Additional selections for use with controller option:*
- |             |          |
|-------------|----------|
| OUTPUT 11   | OUTPUT12 |
| OUTPUT 21   | OUTPUT22 |
| OUTPUT 31   | OUTPUT32 |
| OUTPUT 41   | OUTPUT42 |
| CA1F1 CA1F2 | CA1F3    |
| CA1F4       | CA1F5    |
| CA2F1 CA2F2 | CA2F3    |
| CA2F4       | CA2F5    |
| CA3F1 CA3F2 | CA3F3    |
| CA3F4       | CA3F5    |
| CA4F1 CA4F2 | CA4F3    |
| CA4F4       | CA4F5    |

5. Press the  key to advance to the next parameter, **CONTROL ON ACTUATOR** (only seen on controller).

**CONTROL ON ACTUATOR**  
**ON / CONTINUOUS**

- Selections*  
 NONE/OFF  
 ON/CONTINUOUS  
 ANY ALARM  
 ANY PROCESS ALARM  
 A11 A12 A13 A14  
 A21 A22 A23 A24  
 A31 A32 A33 A34  
 A41 A42 A43 A44  
 INSTRUMENT ALARM  
 CHART FULL  
 OP INP 1 OP INP 2  
 OP INP 3 OP INP 4  
 OP INP 5 OP INP 6  
 OP INP 7 OP INP 8  
 OP INP 9 OP INP 10  
 OP INP 11 OP INP 12  
 CHART CHANGED  
 CHART ROTATION  
 TREND DATA COLLECT  
 ALT CHART SPEED  
 DA1 DA2 DA3  
 DA4 DA5 DA6  
 DA7 DA8 DA9  
 DA10 DA11 DA12  
 DA13 DA14 DA15  
 DA16 DA17 DA18  
 DA19 DA20 DA21  
 DA22 DA23 DA24  
 OUTPUT 11 OUTPUT12  
 OUTPUT 21 OUTPUT22  
 OUTPUT 31 OUTPUT32  
 OUTPUT 41 OUTPUT42  
 PRESET 1 PRESET 2  
 PRESET 3 PRESET 4  
 TOTAL PO1 TOTAL PO2  
 TOTAL PO3 TOTAL PO4  
 TIME 1 TIME/DATE 1  
 TIME 2 TIME/DATE 2  
 TIME 1 TO TIME 2  
 TIME /DATE 1 TO 2  
 TIMER 1 TIMER 2  
 TIMER 3 TIMER 4  
 SW1 SW2 SW3 SW4  
 SW5 SW6 SW7 SW8  
 COMM TRIGGER 1  
 COMM TRIGGER 2  
 COMM TRIGGER 3  
 COMM TRIGGER 4  
 F1 F2 F3 F4 F5  
 RESET MOD ENTER  
 ON THE HOUR  
 DAY OF WEEK  
 DAY OF MONTH  
 RELAY 1 RELAY 2  
 CA1F1 CA1F2 CA1F3  
 CA1F4 CA1F5  
 CA2F1 CA2F2 CA2F3  
 CA2F4 CA2F5  
 CA3F1 CA3F2 CA3F3  
 CA3F4 CA3F5  
 CA4F1 CA4F2 CA4F3  
 CA4F4 CA4F5  
 RELAY 3 RELAY 4  
 RELAY 5 RELAY 6  
 RELAY 7 RELAY 8

Press the  to change, then   ,  
  as required to desired choice, then  
 press the .

6. Press the  to advance to the next parameter, **DATE DISPLAY FORMAT**.

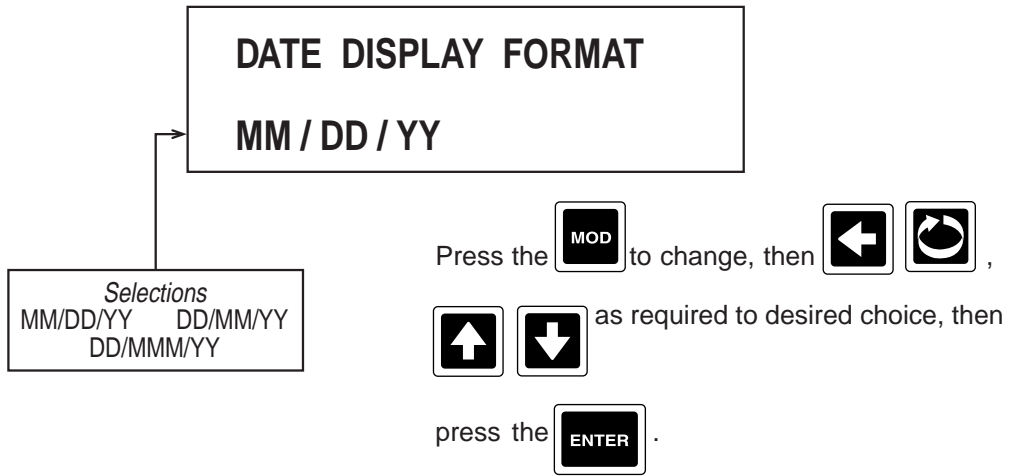

7. Press the  to advance to the next parameter, **TIME DISPLAY FORMAT**.

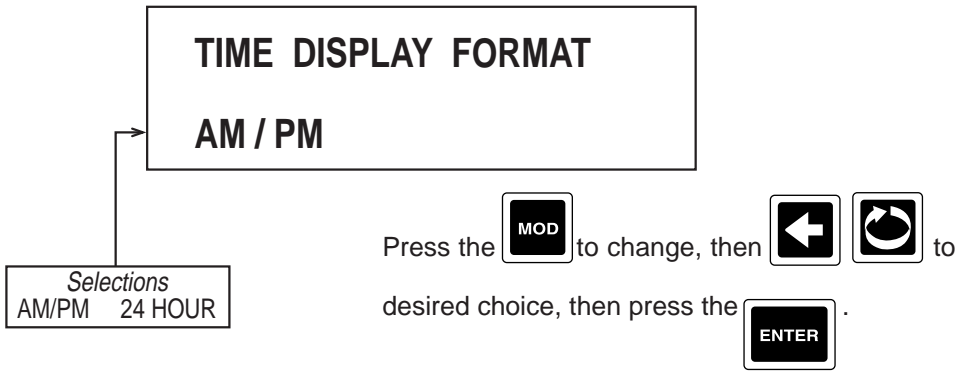

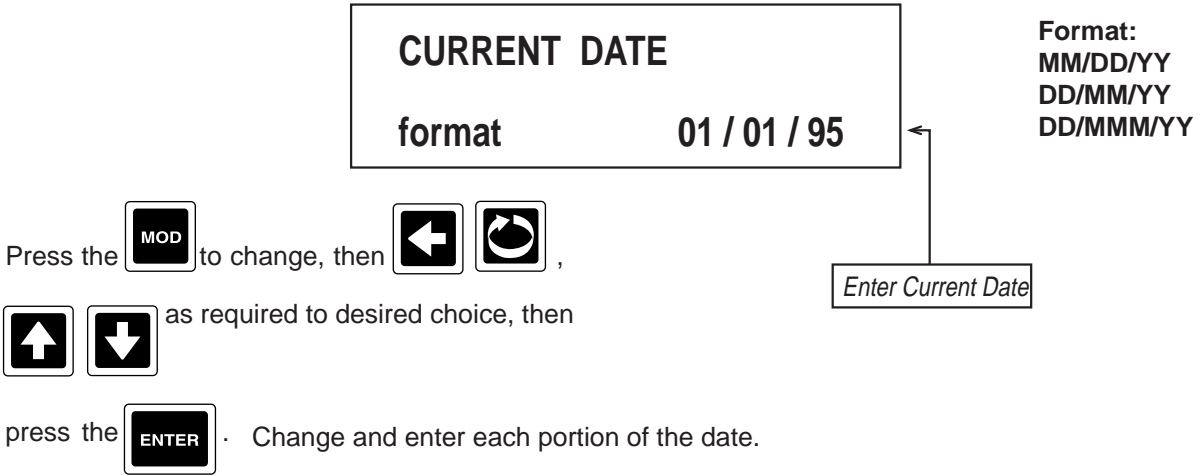

8. Press the  to advance to the next parameter, **CURRENT DATE**.



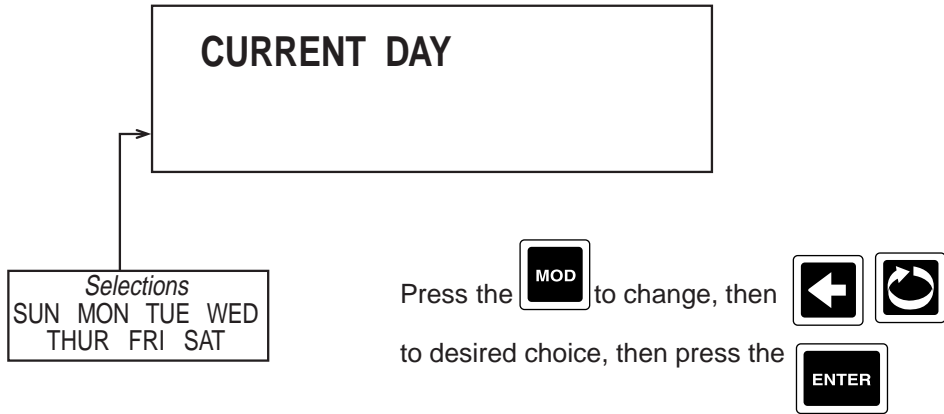

9. Press the  to advance to the next parameter, CURRENT DAY.



10. Press the  to advance to the next parameter, CURRENT TIME.

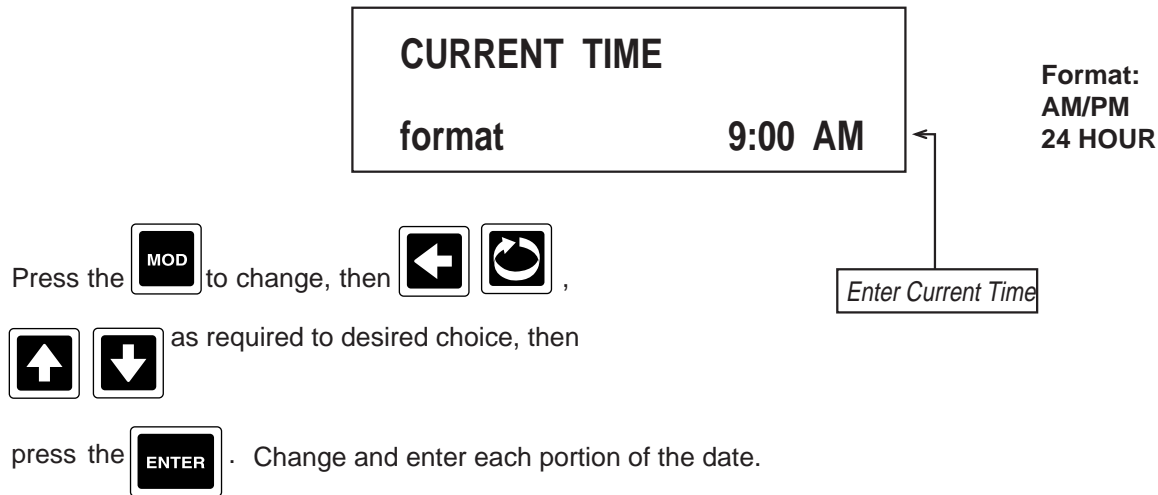

11. Press the  to advance to the next parameter, TIME TO LOG DATA (NOT AVAILABE AT THIS TIME).

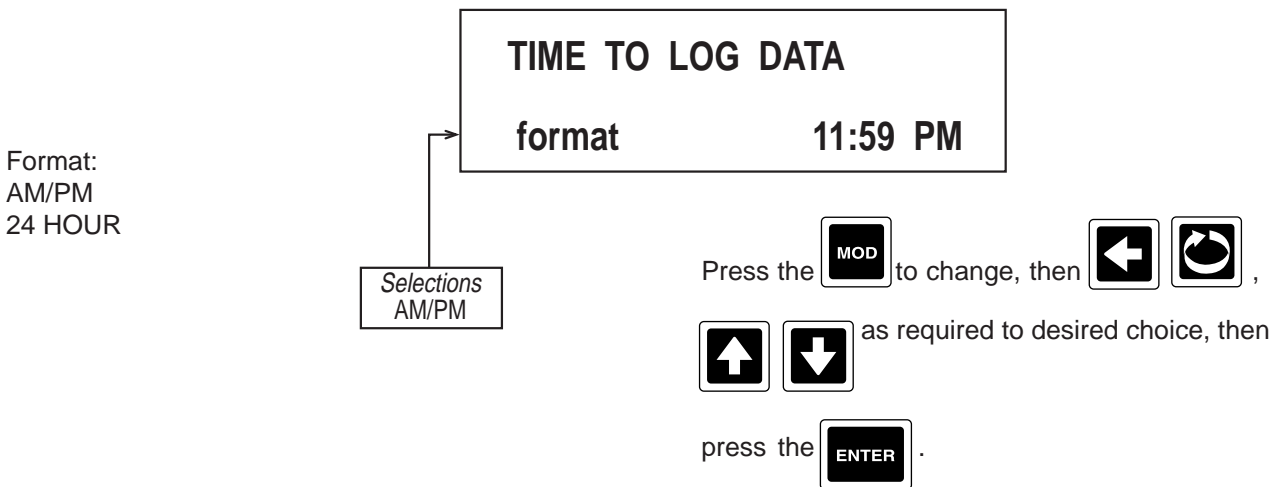

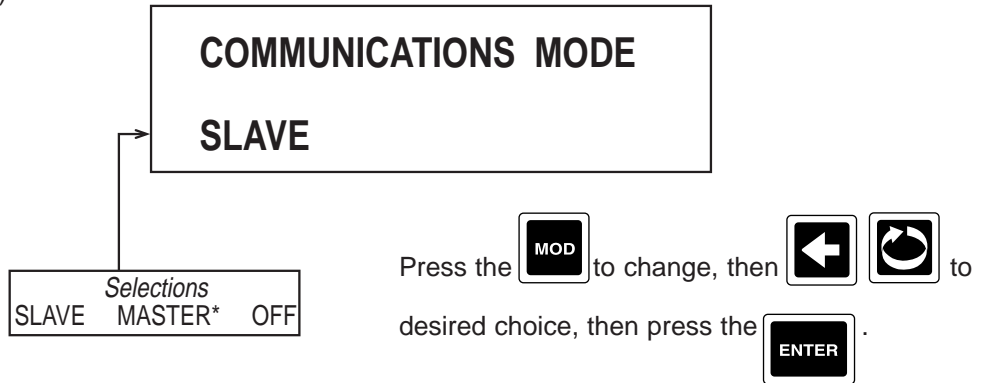

12. Press the  to advance to the next parameter, **COMMUNICATIONS MODE** (Only seen if the communications option is present).



\* NOTE: When Master is selected, the recorder uses the comms address that was previously programmed. No slave unit should use this address. Also, the comms address parameter will not show up if master is selected, it must be programmed prior to the selection of Master.

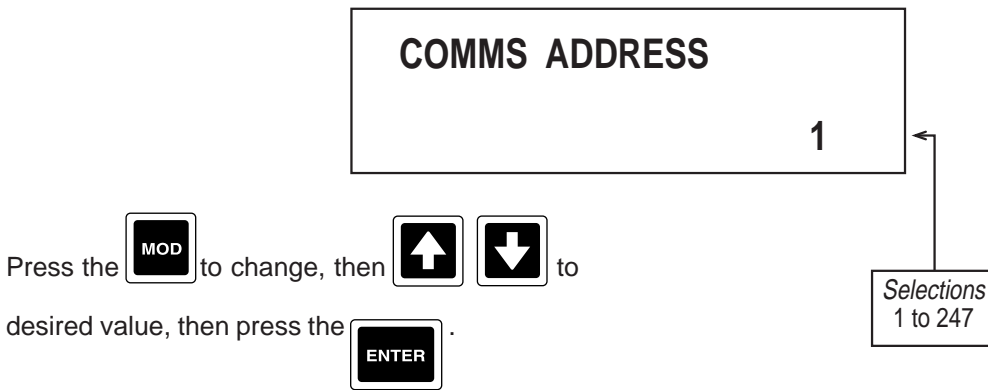

13. Press the  to advance to the next parameter, **COMMS ADDRESS 1** (only seen if SLAVE is selected in COMMUNICATIONS MODE).

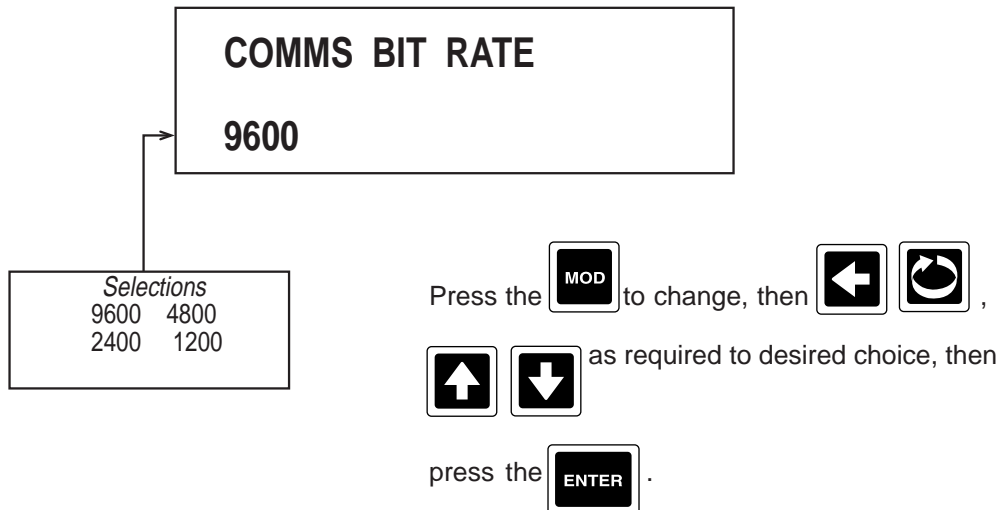

14. Press the  to advance to the next parameter, **COMM BIT RATE**.







17. Press the  and the display advances to **INSTRUMENT TAG**. To exit, press the . Refer to the beginning of this section, page 4-72.

#### **4.1.13 DERIVED ACTUATORS**

Derived Actuators are used when two or more actuators need to be combined logically.

From the Normal Display, press the  until **CONFIGURATION** is seen in the lower display line. If **PASSWORD** appears in the lower display line, the correct "password" will need to be entered before access to Configuration is allowed. If **CONFIGURATION** is not displayed, then Configuration has been disabled. Refer to Section 9, Enables and Passwords, for instructions to enable Configuration.

With **CONFIGURATION** in the display, press the , then the  until **DERIVED ACTUATORS** appears in the lower display line.

1. Press the  to display **DERIVED ACTUATOR**.

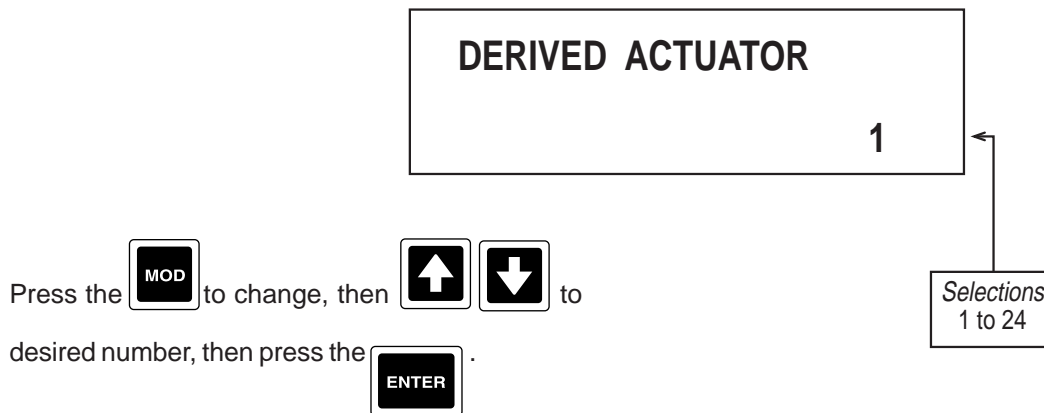

2. Press the  to advance to the next parameter, **COPY/INITIALIZE**.

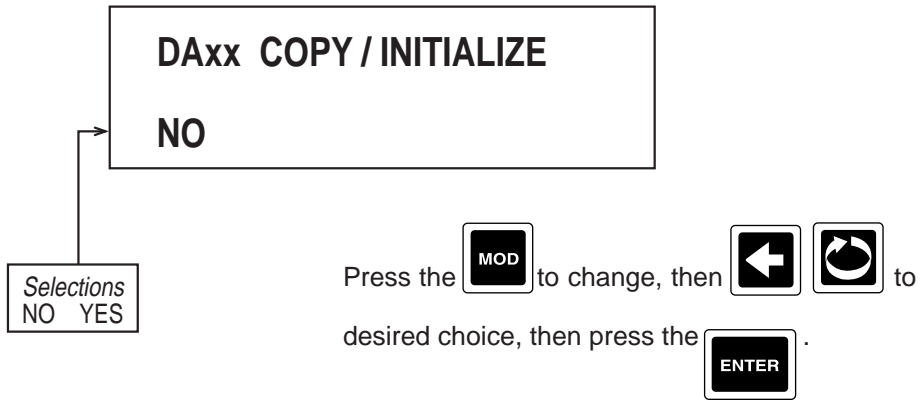

Choose YES if the parameters to be programmed are the same as another DERIVED ACTUATOR already programmed.

**If selection was NO, proceed to step 3.**

**If selection was YES:**

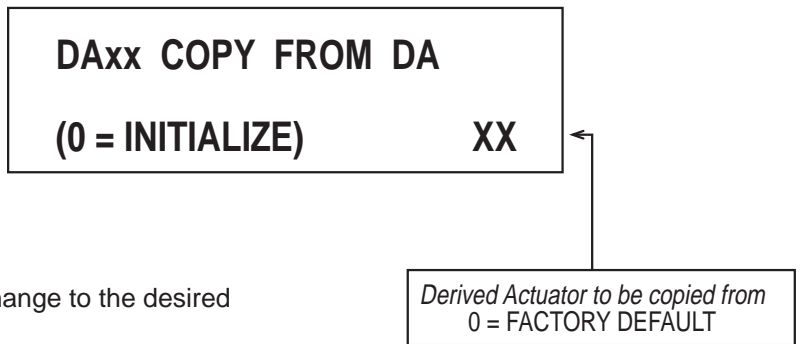

Press the   to change to the desired actuator to be copied from.



3. Press the  to advance to the next parameter, **ITEM 1**.



**DERIVED ACTUATORS**

**D**Axx
**ITEM 1**

*Selections*

END OR AND  
NOT ( )  
ANY ALARM  
ANY PROCESS ALARM  
A11 A12 A13 A14  
A21 A22 A23 A24  
A31 A32 A33 A34  
A41 A42 A43 A44  
INSTRUMENT ALARM  
CHART FULL  
OP INP 1 OP INP 2  
OP INP 3 OP INP 4  
OP INP 5 OP INP 6  
OP INP 7 OP INP 8  
OP INP 9 OP INP 10  
OP INP 11 OP INP 12  
CHART CHANGED  
CHART ROTATION  
TREND DATA COLLECT  
ALT CHART SPEED  
DA1 DA2 DA3  
DA4 DA5 DA6  
DA7 DA8 DA9  
DA10 DA11 DA12  
DA13 DA14 DA15  
DA16 DA17 DA18  
DA19 DA20 DA21  
DA22 DA23 DA24  
PRESET 1 PRESET 2  
PRESET 3 PRESET 4  
TOTAL PO1 TOTAL PO2  
TOTAL PO3 TOTAL PO4  
TIME 1 TIME/DATE 1  
TIME 2 TIME/DATE 2  
TIME 1 TO TIME 2  
TIME /DATE 1 TO 2  
TIMER 1 TIMER 2  
TIMER 3 TIMER 4  
SW1 SW2 SW3 SW4  
SW5 SW6 SW7 SW8  
COMM TRIGGER 1  
COMM TRIGGER 2  
COMM TRIGGER 3  
COMM TRIGGER 4  
F1 F2 F3 F4 F5  
RESET MOD ENTER  
ON THE HOUR  
DAY OF WEEK  
DAY OF WEEK  
RELAY 1 RELAY 2  
RELAY 3 RELAY 4  
RELAY 5 RELAY 6  
RELAY 7 RELAY 8

Press the  to change, then   ,

  as required to desired choice, then

press the  .

*Additional selections for use with controller option:*

OUTPUT 11 OUTPUT12  
OUTPUT 21 OUTPUT22  
OUTPUT 31 OUTPUT32  
OUTPUT 41 OUTPUT42  
CA1F1 CA1F2 CA1F3  
CA1F4 CA1F5  
CA2F1 CA2F2 CA2F3  
CA2F4 CA2F5  
CA3F1 CA3F2 CA3F3  
CA3F4 CA3F5  
CA4F1 CA4F2 CA4F3  
CA4F4 CA4F5

Repeat the ITEM prompt as needed to configure the items necessary to form the desired logic equation.

4. Press the  and the display advances to the next derived actuator to be programmed. Refer to the beginning of this section, page 4-80.

**4.1.14 OPERATOR INPUTS**

Operator Inputs are prompts programmed that allow these prompts to turn on or off actuators that control some other function within the instrument.

From the Normal Display, press the  until **CONFIGURATION** is seen in the lower display line. If **PASS-WORD** appears in the lower display line, the correct "password" will need to be entered before access to Configuration is allowed. If **CONFIGURATION** is not displayed, then Configuration has been disabled. Refer to Section 9, Enables and Passwords, for instructions to enable Configuration.

With **CONFIGURATION** in the display, press the , then the  until **OPERATOR INPUTS** appears in the lower display line.

1. Press the  to display **OPERATOR INPUT**.

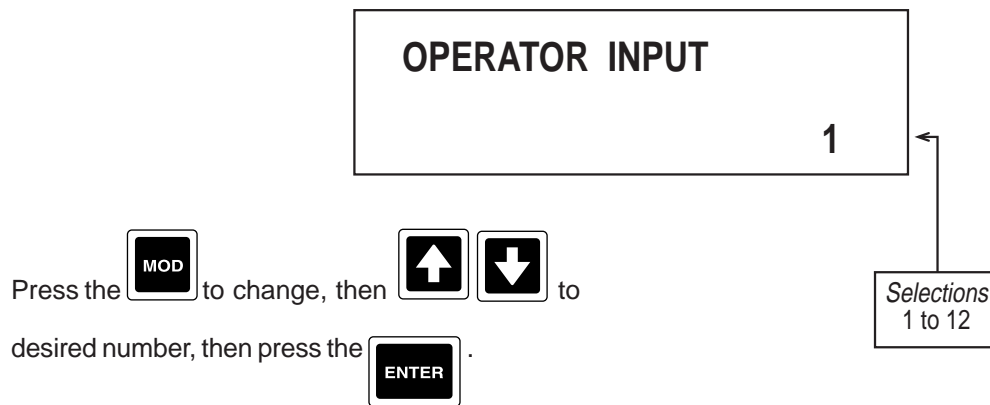

2. Press the  to advance to the next parameter, **COPY/INITIALIZE**.

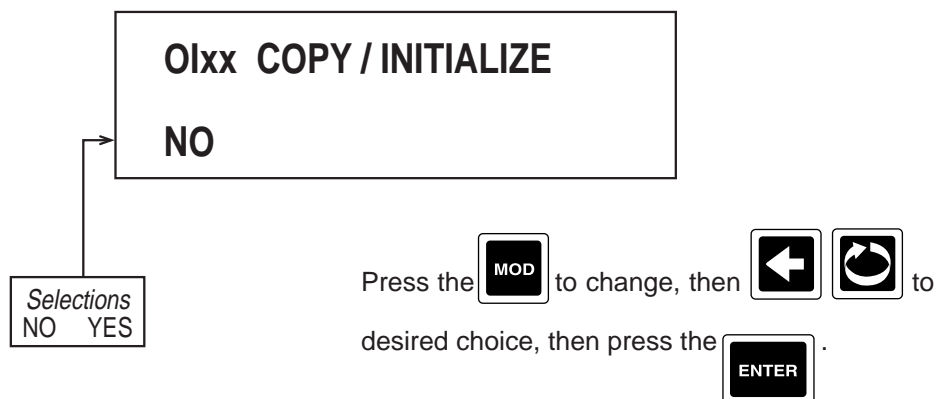





4. Press the  to advance to the next parameter, **OFF STATE TEXT**.

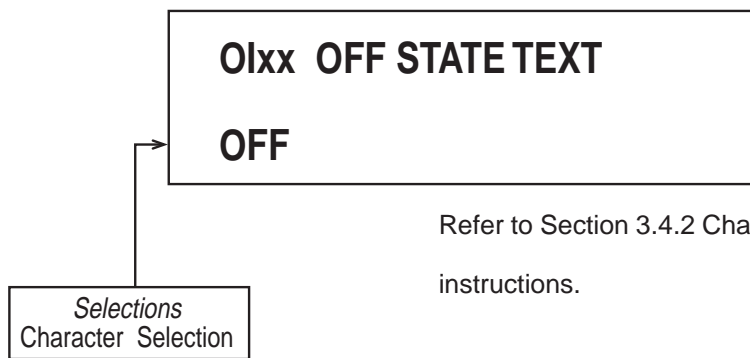

Refer to Section 3.4.2 Changing Text, page 3-3 for instructions.



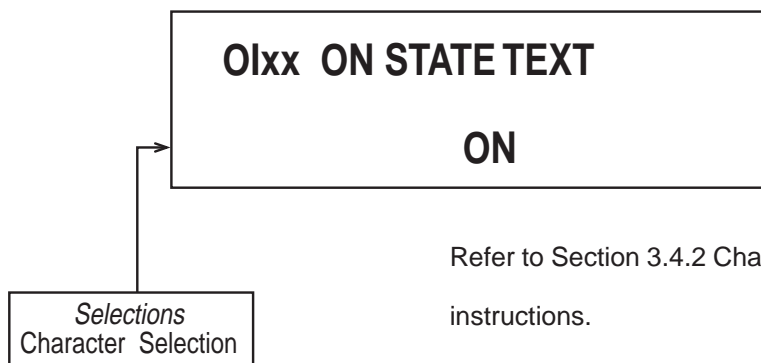

5. Press the  to advance to the next parameter, **ON STATE TEXT**.

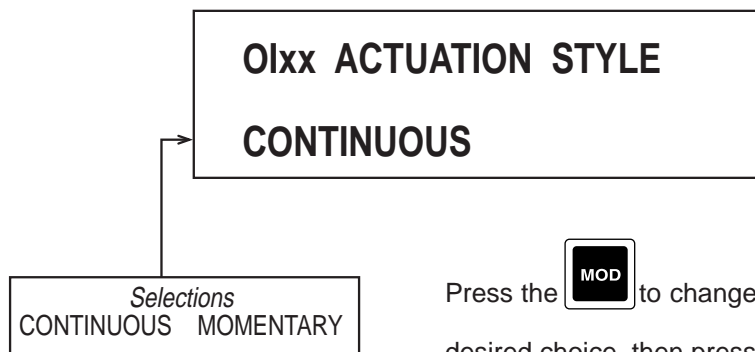

Refer to Section 3.4.2 Changing Text, page 3-3 for instructions.

6. Press the  to advance to the next parameter, **ACTUATION STYLE**.



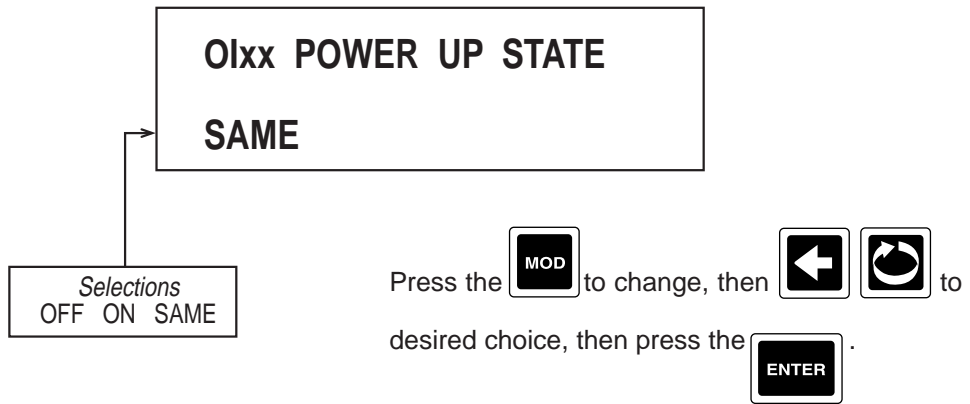

Press the  to change, then   to desired choice, then press the .

7. Press the  to advance to the next parameter, **POWER UP STATE**.

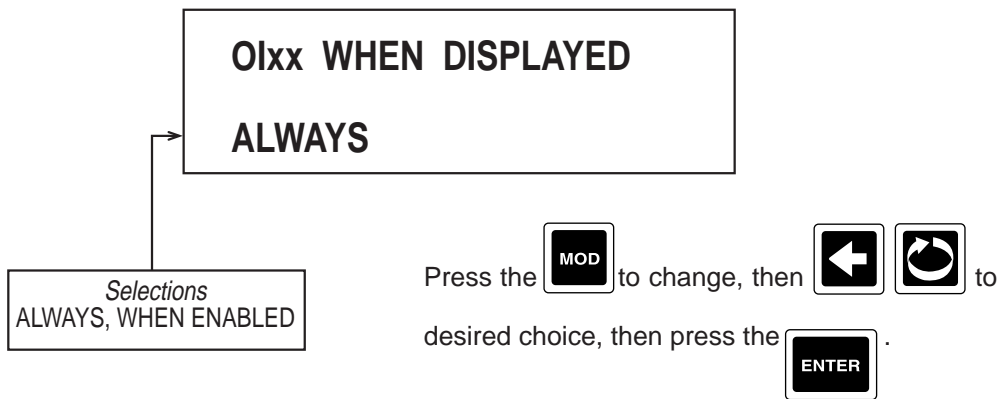

8. Press the  to advance to the next parameter, **WHEN DISPLAYED**.



9. Press the  and the display advances to the next operator input to be programmed. Refer to the beginning of this section, page 4-81.

#### 4.1.15 OPERATOR MESSAGES

Operator Messages are user defined messages to advise or provide information, via the display, that selected actuators are active.

From the Normal Display, press the  until **CONFIGURATION** is seen in the lower display line. If **PASS-WORD** appears in the lower display line, the correct "password" will need to be entered before access to Configurat allowed. If **CONFIGURATION** is not displayed, then Configuration has been disabled. Refer to Section 9, Enables and Passwords, for instructions to enable Configuration.

With **CONFIGURATION** in the display, press the  then the  until **OPERATOR MESSAGES** appears in the lower display line.

1. Press the  to display **OPERATOR MESSAGE**.

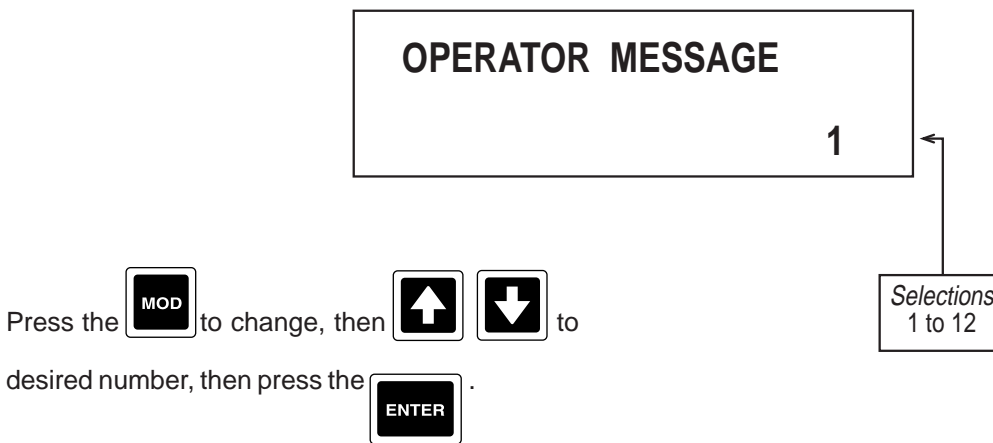

2. Press the  to advance to the next parameter, **COPY/INITIALIZE**.

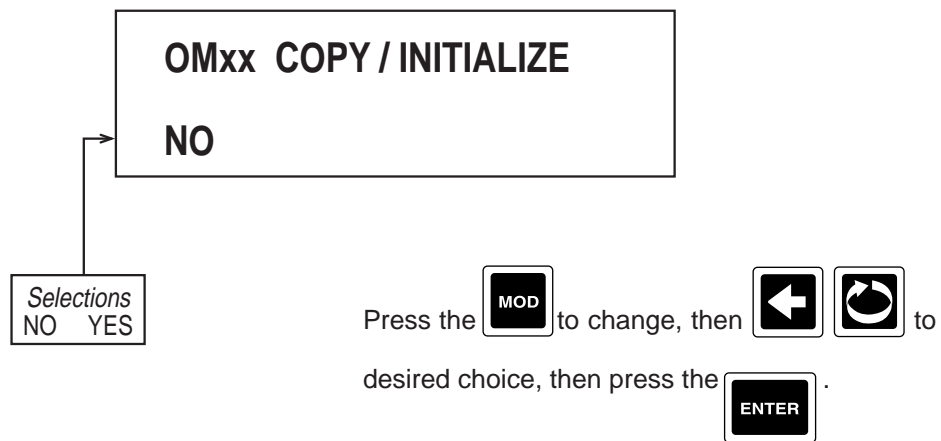

Choose YES if the parameters to be programmed are the same as another OPERATOR MESSAGE already programmed.

If selection was NO, proceed to step 3.

If selection was YES:

**OPERATOR  
MESSAGES**

**OMxx COPY FROM OM**  
**(0 = INITIALIZE) 1**

Press the   to change to the desired operator message to be copied from.

*Operator Message to be copied from*  
**0 = FACTORY DEFAULT**

3. Press the  to advance to the next parameter, **ACTUATOR**.

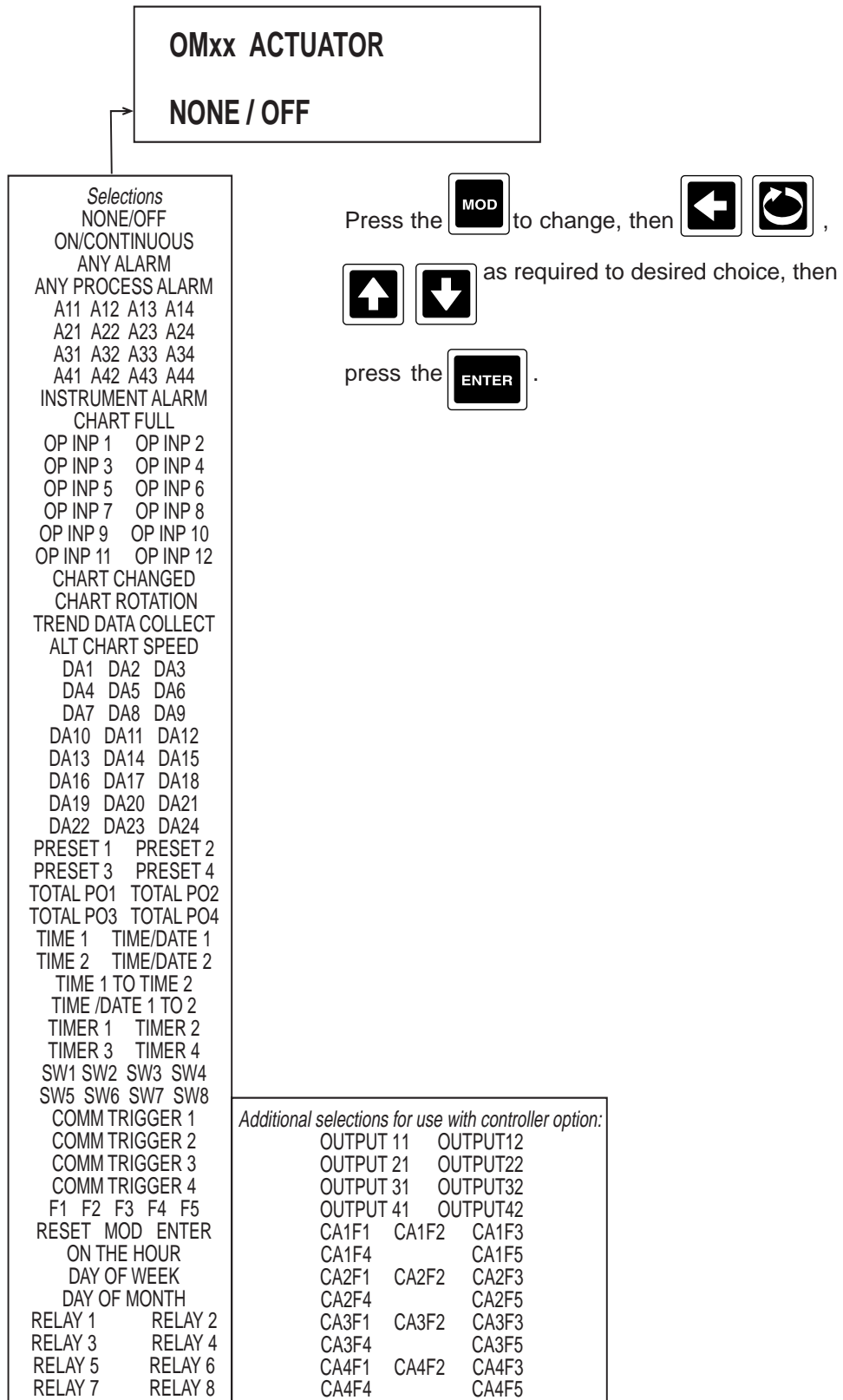

4. Press the  to advance to the next parameter, **LINE 1 TEXT**.

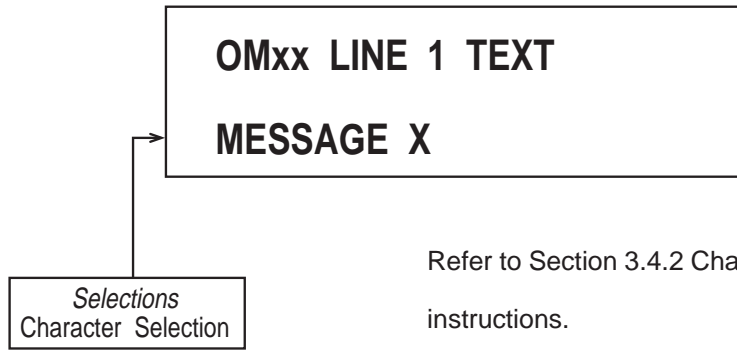

Refer to Section 3.4.2 Changing Text, page 3-3 for instructions.



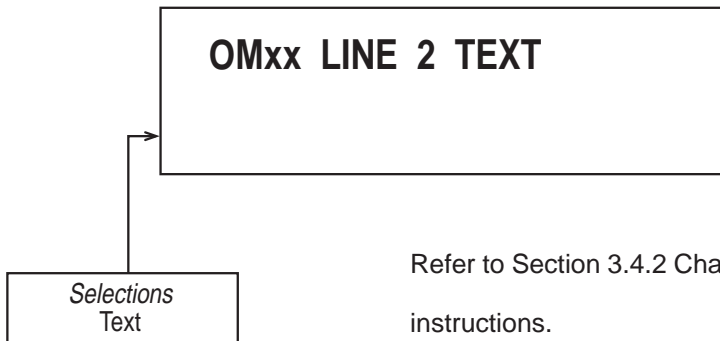

5. Press the  to advance to the next parameter, **LINE 2 TEXT**.

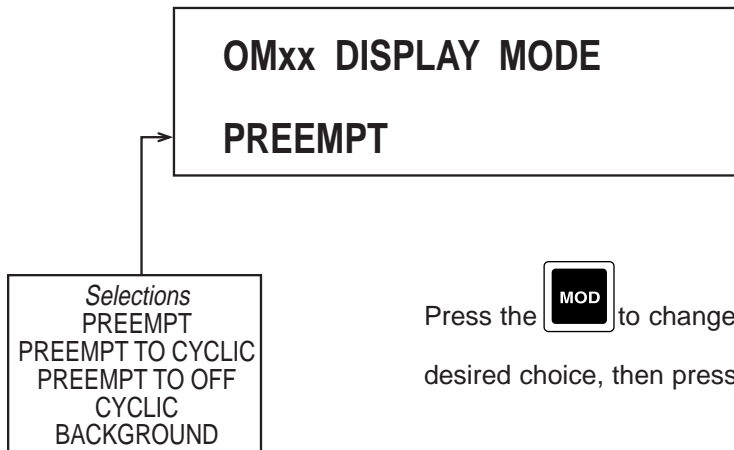

Refer to Section 3.4.2 Changing Text, page 3-3 for instructions.

6. Press the  to advance to the next parameter, **DISPLAY MODE**.



Press the  to change, then   to desired choice, then press the .

7. Press the  and the display advances to the next operator message to be programmed. Refer to the beginning of this section, page 4-85.

#### 4.1.16 CHART MESSAGES

Chart Messages allow user defined text to be recorded on the chart.

From the Normal Display, press the  until **CONFIGURATION** is seen in the upper display line. If **PASS-WORD** appears in the lower display line, the correct "password" will need to be entered before access to Configuration is allowed. If **CONFIGURAITON** is not displayed, then Configuration has been disabled. Refer to Section 9, Enables and Passwords, for instructions to enable Configuration.

With **CONFIGURATION** in the display, press the  , then the  **CHART MESSAGES** appears in the lower display line.

1. Press the  to display **CHART MESSAGES**.

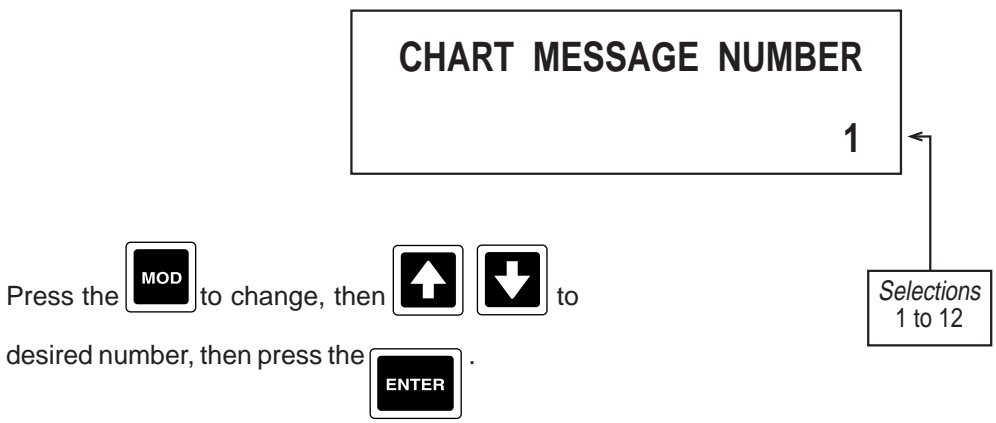

2. Press the  to advance to the next parameter, **COPY/INITIALIZE**.

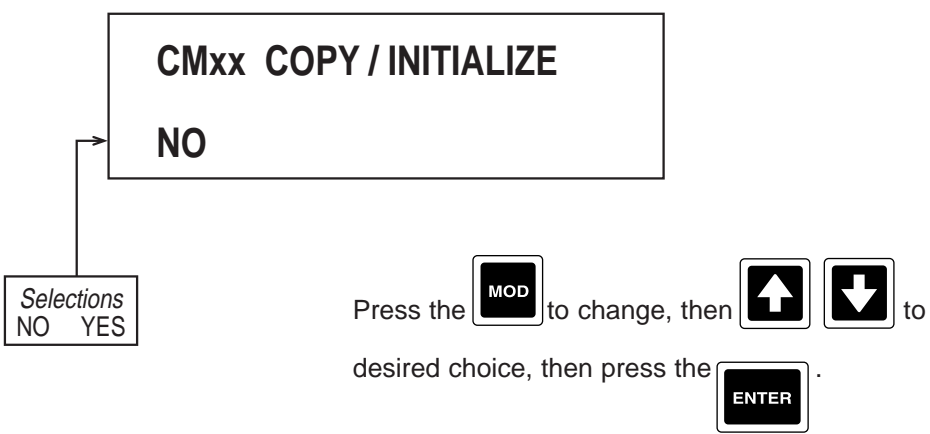

Choose YES if the parameters to be programmed are the same as another CHART MESSAGE already programmed.



**C  
H  
A  
R  
T  
  
M  
E  
S  
S  
A  
G  
E  
S**

If selection is NO, proceed to step 3.

If selection is YES:

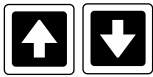
**CMxx COPY FROM CM**  
**(0 = INITIALIZE)                      1**



Press the   to change to the desired chart message to be copied from.

*Chart Message to be copied from*  
**0 = FACTORY DEFAULT**











3. Press the  to advance to the next parameter, **ACTUATOR**.

**CMxx ACTUATOR**

**NONE / OFF**

Press the  to change, then  ,

  as required to desired choice, then

press the .

*Selections*

NONE/OFF  
 ON/CONTINUOUS  
 ANY ALARM  
 ANY PROCESS ALARM  
 A11 A12 A13 A14  
 A21 A22 A23 A24  
 A31 A32 A33 A34  
 A41 A42 A43 A44  
 INSTRUMENT ALARM  
 CHART FULL  
 OP INP 1 OP INP 2  
 OP INP 3 OP INP 4  
 OP INP 5 OP INP 6  
 OP INP 7 OP INP 8  
 OP INP 9 OP INP 10  
 OP INP 11 OP INP 12  
 CHART CHANGED  
 CHART ROTATION  
 TREND DATA COLLECT  
 ALT CHART SPEED  
 DA1 DA2 DA3  
 DA4 DA5 DA6  
 DA7 DA8 DA9  
 DA10 DA11 DA12  
 DA13 DA14 DA15  
 DA16 DA17 DA18  
 DA19 DA20 DA21  
 DA22 DA23 DA24  
 PRESET 1 PRESET 2  
 PRESET 3 PRESET 4  
 TOTAL PO1 TOTAL PO2  
 TOTAL PO3 TOTAL PO4  
 TIME 1 TIME/DATE 1  
 TIME 2 TIME/DATE 2  
 TIME 1 TO TIME 2  
 TIME /DATE 1 TO 2  
 TIMER 1 TIMER 2  
 TIMER 3 TIMER 4  
 SW1 SW2 SW3 SW4  
 SW5 SW6 SW7 SW8  
 COMM TRIGGER 1  
 COMM TRIGGER 2  
 COMM TRIGGER 3  
 COMM TRIGGER 4  
 F1 F2 F3 F4 F5  
 RESET MOD ENTER  
 ON THE HOUR  
 DAY OF WEEK  
 DAY OF MONTH  
 RELAY 1 RELAY 2  
 RELAY 3 RELAY 4  
 RELAY 5 RELAY 6  
 RELAY 7 RELAY 8

*Additional selections for use with controller option:*

OUTPUT 11 OUTPUT12  
 OUTPUT 21 OUTPUT22  
 OUTPUT 31 OUTPUT32  
 OUTPUT 41 OUTPUT42  
 CA1F1 CA1F2 CA1F3  
 CA1F4 CA1F5  
 CA2F1 CA2F2 CA2F3  
 CA2F4 CA2F5  
 CA3F1 CA3F2 CA3F3  
 CA3F4 CA3F5  
 CA4F1 CA4F2 CA4F3  
 CA4F4 CA4F5

4. Press the  to advance to the next parameter, **PEN/COLOR**.

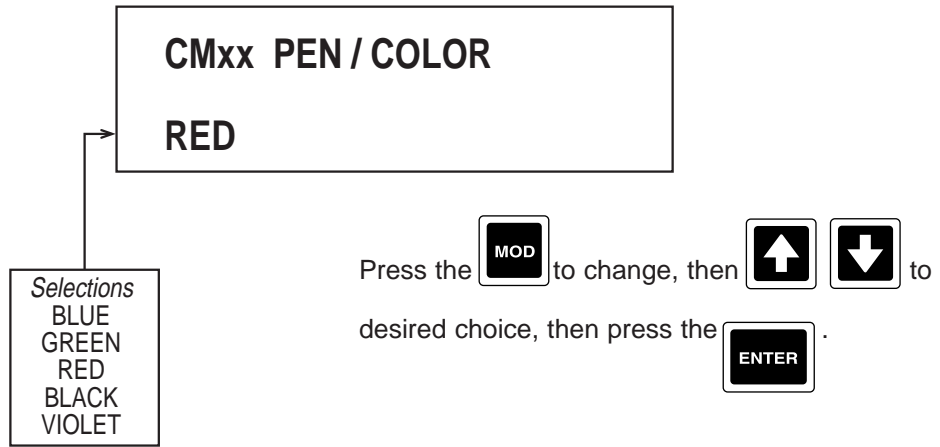

*Note: Valid choice of color depends on number of colors specified when ordered. One color - Red, Two colors - Red, Green; Three colors - Red, Green, Blue or Four colors - Red, Green, Blue, Black or Violet.*

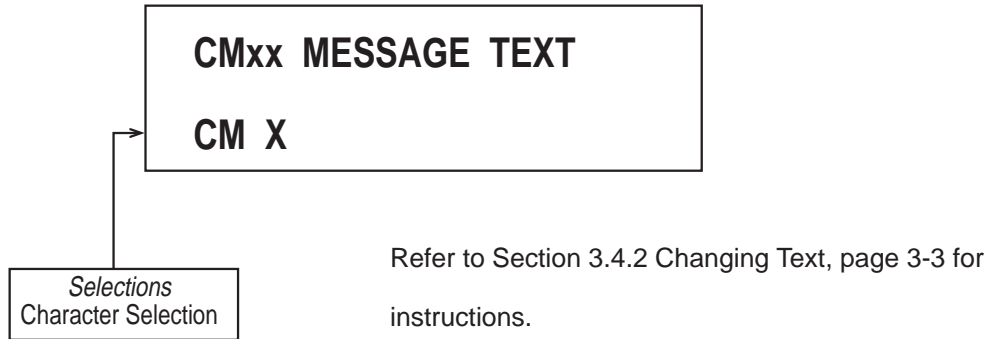

5. Press the  to advance to the next parameter, **MESSAGE TEXT**.





6. Press the  to advance to the next parameter, **VALUE 1**.

**CMxx VALUE 1**

**NONE USED**

Press the  to change, then  ,

  as required to desired choice, then

press the .



<i>Selections</i>	
NONE USED	
IV1 IV2 IV3 IV4	
IV5 IV6 IV7 IV8	
PV1 PV2 PV3 PV4	
DV1 DV2 DV3	
DV4 DV5 DV6	
DV7 DV8 DV9	
DV10 DV11 DV12	
CV1 CV2 CV3 CV4	
CV5 CV6 CV7 CV8	
CV9 CV10 CV11 CV12	
TOTAL1 TOTAL2	
TOTAL3 TOTAL4	
SV1 SV2 SV3 SV4	



<i>Additional selections for use with controller option:</i>	
SP1 SP2 SP3 SP4	
SP5 SP6 SP7 SP8	
OUTPUT 11	OUTPUT12
OUTPUT 21	OUTPUT22
OUTPUT 31	OUTPUT32
OUTPUT 41	OUTPUT42

7. Press the  to advance to the next parameter, **VALUE 2**.

**CMxx VALUE 2**

**NONE USED**

Press the  to change, then  ,

  as required to desired choice, then

press the .

<i>Selections</i>	
NONE USED	
IV1 IV2 IV3 IV4	
IV5 IV6 IV7 IV8	
PV1 PV2 PV3 PV4	
DV1 DV2 DV3	
DV4 DV5 DV6	
DV7 DV8 DV9	
DV10 DV11 DV12	
CV1 CV2 CV3 CV4	
CV5 CV6 CV7 CV8	
CV9 CV10 CV11 CV12	
TOTAL1 TOTAL2	
TOTAL3 TOTAL4	
SV1 SV2 SV3 SV4	

<i>Additional selections for use with controller option:</i>	
SP1 SP2 SP3 SP4	
SP5 SP6 SP7 SP8	
OUTPUT 11	OUTPUT12
OUTPUT 21	OUTPUT22
OUTPUT 31	OUTPUT32
OUTPUT 41	OUTPUT42

8. Press the  to advance to the next parameter, **VALUE 3**.

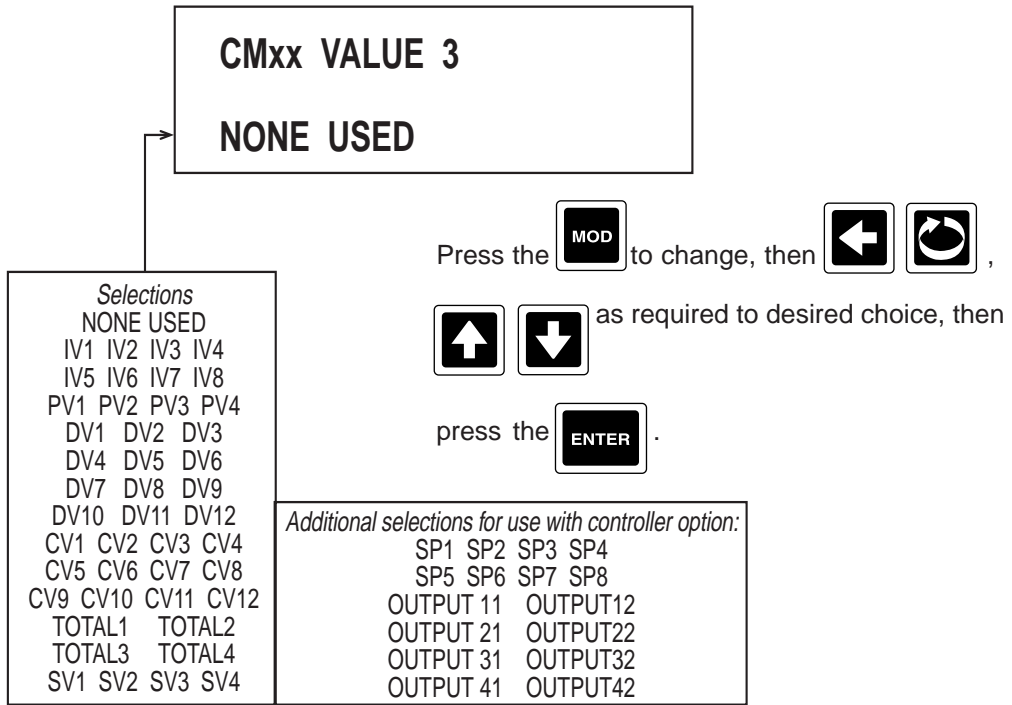

9. Press the  to advance to the next parameter, **VALUE 4**.

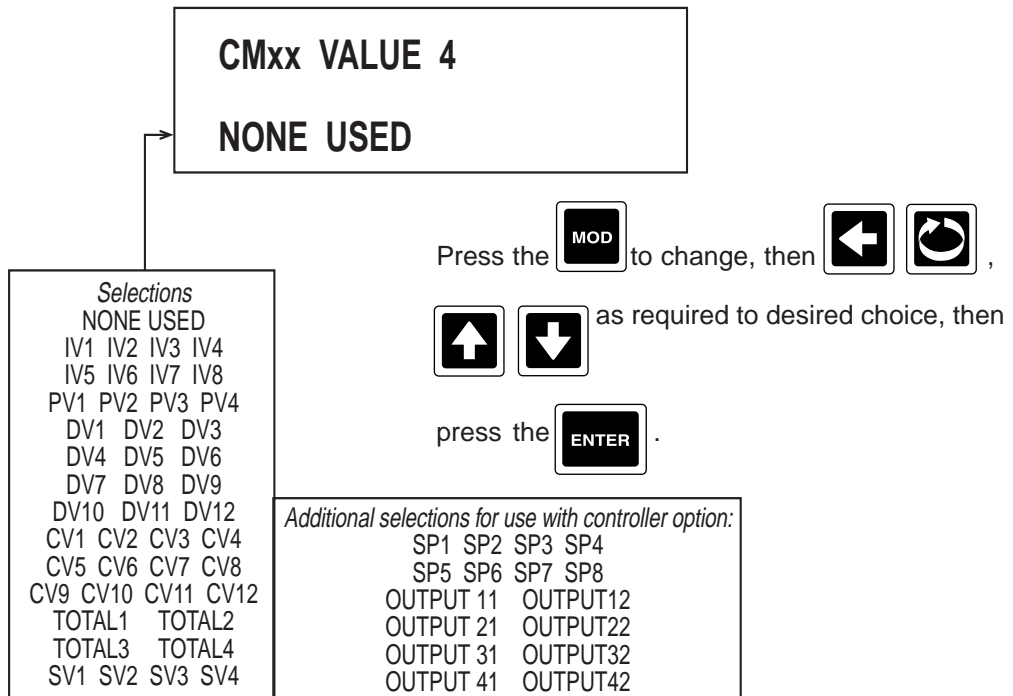

10. Press the  to advance to the next parameter, **TIME/DATE STAMP**.

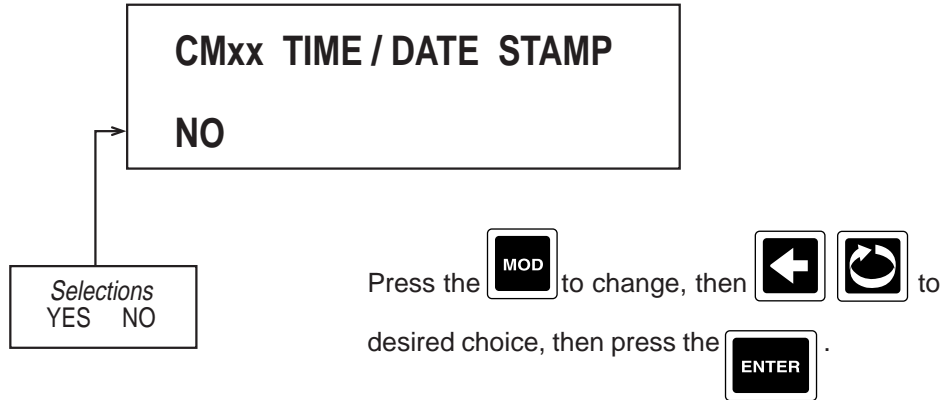

11. Press the  to advance to the next parameter, **CMSS ORIENTATION**.

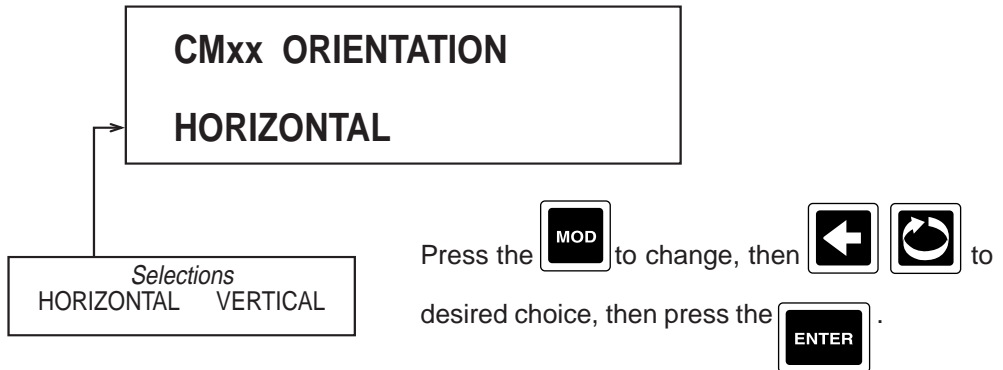

12. Press the  and the display advances to the next chart message to be programmed. Refer to the beginning of this section, page 4-89.

**4.1.17 SIMULATED VARIABLES**





Simulated Variables typically used for testing purposes.

From the Normal Display, press  the until **CONFIGURATION** is seen in the upper display line. If **PASS-WORD** appears in the lower display line, the correct "password" will need to be entered before access to Configuration is allowed. If **CONFIGURATION** is not displayed, then Configuration has been disabled. Refer to Section 9, Enables and Passwords, for instructions to enable Configuration.

With **CONFIGURATION** is the display, press the  then the  until **SIMULATED VARIABLES** appears in the lower display line.

1. Press the  to display **SV NUMBER**.



Press the  to change, then   to desired number, then press the .

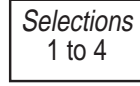



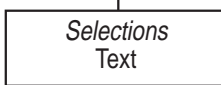

2. Press the  to advance to the next parameter, **DISPLAY TAG**.

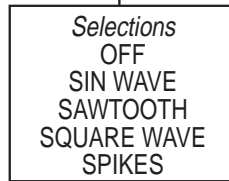

Refer to Section 3.4.2 Changing Text, page 3-3 for instructions.

3. Press the  to advance to the next parameter, **TYPE**.



Press the  to change, then  to desired choice, then press the .

If OFF was selected, no other prompts for SIMULATED VARIABLES X will be seen. Refer back to step 1, page 4-97.

4. Press the  to advance to the next parameter, **DISPLAY UNITS**.

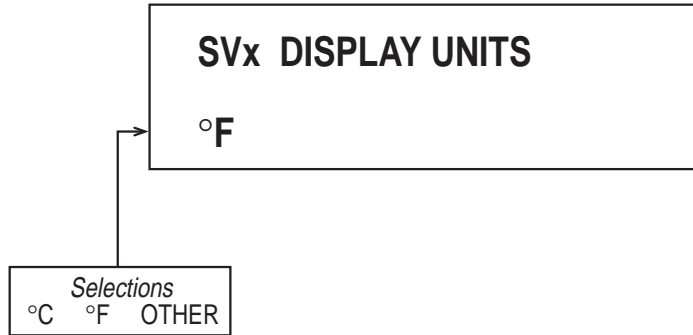

5. If **DISPLAY UNITS** selected was **OTHER**, press the  to advance to the next parameter, **OTHER UNITS**.

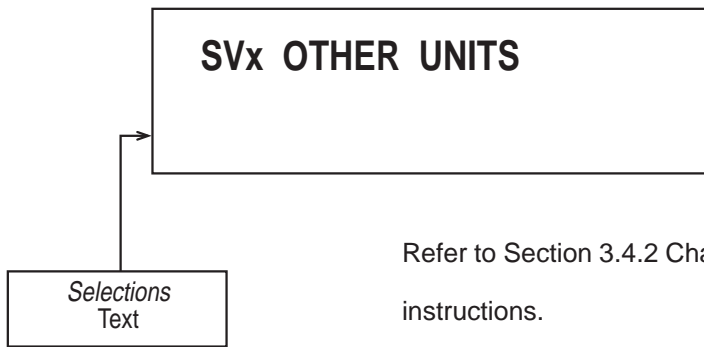



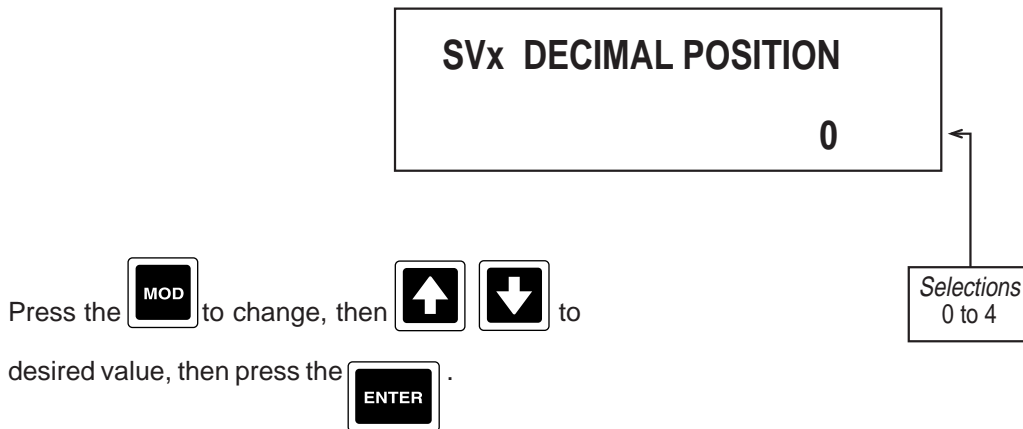

6. Press the  to advance to the next parameter, **DECIMAL POSITION**.



**Units correspond to Units configured in Simulated Variable**

7. Press the  to advance to the next parameter, **RANGE LOW**.





**SVx RANGE LOW**  
0 units

Press the  to change, then   to desired value, then press the .

*Selections*  
± 999999  
(decimal position = 0)  
± 9.9999  
(decimal position = 4)

8. Press  the to advance to the next parameter, **RANGE HIGH**.

**SVx RANGE HIGH**  
100 units

Press the  to change, then   to desired value, then press the .

*Selections*  
± 999999  
(decimal position = 0)  
± 9.9999  
(decimal position = 4)

**Units correspond to  
Units configured in  
Simulated Variable**



9. Press the  to advance to the next parameter, **PERIOD**.

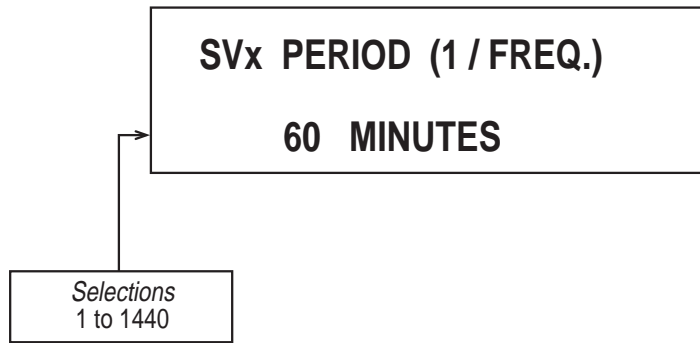

10. Press the  to advance to the next parameter, **DISPLAY OPTION**.

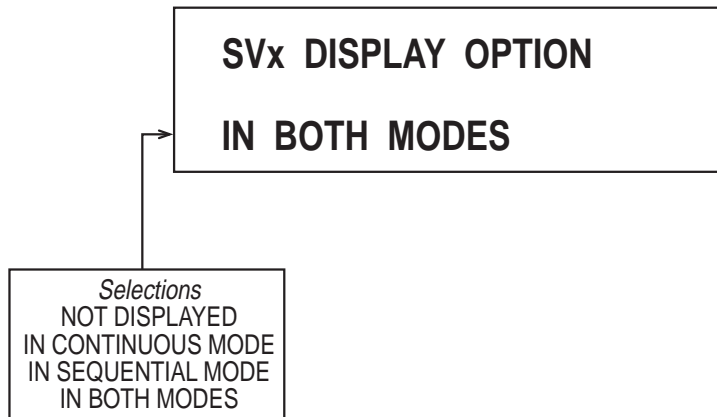

11. Press the  and the display advances to the next simulated input to be programmed. Refer to the beginning of this section, page 4-95.

---

## Section 5 - Display Programming

Selections made in the Display prompts section determine what is displayed and how it is displayed.

From the Normal Display, press the . If the Display prompts are disabled, when the DISP key is pressed, **DISPLAY KEY DISABLED** will appear in the lower display line. Refer to Section 9, Enables and Passwords, for instructions to enable Display prompts.

If the Display Prompts are not disabled BUT the password is other than zero, **DISPLAY KEY PASSWORD** will appear in the display when the DISP key is pressed. If the correct "password" is entered, **DISPLAY MODE** will appear in the upper display line. If the incorrect "password" is entered, **INVALID PASSWORD** will appear in the upper display line.

If the Display Prompts are not disabled AND the password is set to zero, when the  key is pressed, **DISPLAY MODE** will appear in the upper display line.

For the prompts associated with the  key, the unit automatically goes into the modify mode. For simplicity of operation, use the Special keys below the display, referred to as F1 thru F5, for making choice selections. Upon selection of a new choice/value, the unit will again automatically go into the modify mode.

In this prompt section, use the  key to advance to the next prompt without modifying the current parameter.

1. If instrument is a Controller, the following prompts may appear up to (4) times, one for each CONTROL STATE ACCESS (CA) configured in CONTROL STATE ACCESS section of CONFIGURATION. The prompts are visible for CAx if **CAx LINE 1 TEXT** is not blank. In the description of these prompts, **x** is the CA number, 1-4, and, if the defaults are not changed, the controller number.

tttttttttttttttttttttt	default "CONTROLLER x STATES"
vvvvvvvvvvvvvvvvvvvv	Automatic Modify Mode (AMM) used, default "A/M SP1/SP2 L/R"





The "t" field is the configured **CAx LINE 1 TEXT** and the "v" field is the configured **CAx LINE 2 TEXT**. Note that although AMM is in use, none of the fields in this prompt are modifiable, and none will be flashing.

2. When the above prompt is displayed, if any function keys for CAx have usage other than NOT USED, pressing that key will display the following:

tttttttttttttttttttttt	default "CONTROLLER x STATE"
(CC)	AMM used

The "t" field is the configured **CAx Fn LINE 1 TEXT**, where "n" is the function key number, 1-5. The "cc" field is a two item choice which causes the **CAxFn** actuator to be cleared (left choice) or set (right choice). The choice text will be as configured if the usage is **CUSTOM**, otherwise it will be one of **AUTOMATIC/MANUAL, SP1/SP2 or LOCAL/REMOTE**.



To change the setpoint, press the  key, then   keys to desired setpoint, then press the  key.

To exit, press the  key.

5. Following the top level Setpoint Prompt, if any controllers are configured for PID control and are in manual mode, the following prompt will appear:

**SELECT  
MANUAL VALUES**

This prompt provides an alternative method of manually changing controller outputs. When this prompt is displayed, pressing the  key will display the following:

<b>Cx OUTPUT 1</b>	visible if output 1 proportional
<b>MANUAL OUTPUT</b>	<b>nnn%</b> value 0-100, initially current value
<b>Cx OUTPUT 2</b>	visible if output 2 proportional
<b>MANUAL OUTPUT</b>	<b>nnn%</b> value 0-100, initially current value

These prompts are displayed for each controller in manual mode, where x is the controller number, 1-4.

To change, press the  key, then   keys to desired setting, then press the  key.

To exit, press the  key.

6. Following the top level Manual Values prompts, the "Standard Display" prompts are displayed as follows:

**DISPLAY MODE**

**CONTINUOUS SEQUENCE**      AMM used, default CONTINUOUS

**DISPLAY FORMAT**

**1 VAL 2 VALS 4 VALS**              AMM used, default 1 VAL

**SEQUENTIAL DISPLAY**

**DURATION n SECONDS**      SEQUENCE, AMM used, default 1

7. If any OPERATOR INPUTS (OIs) are configured and visible, they appear in numerical order following the above prompts. The prompts are as follows:

**pppppppppppppppppppppppppppppp**      programmable prompt text

**nnnnnnnnnnnyyyyyyyyyyy**              AMM used, see below

The second line is a choice list with two items, the "n" item being the programmable OFF STATE TEXT phrase associated with the OI, and the "y" item being the programmable ON STATE TEXT.

An OI is configured when its prompt text as Configured in OPERATOR INPUTS section of CONFIGURATION, is not blank. It is visible when the following conditions apply:

- WHEN DISPLAYED (prompt in OPERATOR INPUTS) configured to always
- or
- if configured to ENABLED in ENABLES & PASSWORDS.

---

## Section 6 - Chart Prompts

From the Normal Display, press the . If the Chart Prompts are disabled, when the CHART key is pressed,

**CHART KEY DISABLED** will appear in the lower display. Refer to Section 9, Enables & Passwords, for instructions to enable Chart Prompts.

If the Chart Prompts are not disabled BUT the password is other than zero, **CHART PROMPTS PASSWORD** will appear in the display when the CHART key is pressed. If the correct "password" is entered, **CHANGE CHART** will appear in the upper display. If the incorrect "password" is entered, **INVALID PASSWORD** will appear in the upper display.

If the Chart Prompts is not disabled AND the password is set to zero, when the CHART key is pressed, **CHANGE CHART** will appear in the upper display.

For the prompts associated with the CHART key, the unit automatically goes into the modify mode, unless the prompt is for SELECT CHART CONFIGURATION. For simplicity of operation etc., upon selection of a new choice, the unit will automatically go into the modify mode, unless its a special case as noted below.



In this prompt section, use the CHART key to advance to the next prompt without modifying the current parameter.

**IMPORTANT: The CHANGE CHART procedure shown below must be followed. If it is not, important information (chart tags, time, scales, etc) may not be printed.**

---



### 6.1 CHANGE CHART

1. Press the . **CHANGE CHART** appears in the upper display line and **NO YES** (NO blinking) appears in the lower display line. If the chart has previously been stopped for changing, this prompt may not appear.

2. Select **YES** by pressing the key directly below the displayed **YES** or by pressing the  or  until **YES** is blinking, then press the .

3. **START NEW CHART** appears in the top display and **NO YES** (NO blinking) appears in the bottom display.

4. Change the chart at this time.

5. Select **YES** by pressing the key directly below the displayed **YES** or by pressing the  or  until **YES** is blinking, then press the .

(Continued on next page)

6. Upon selection of **YES**, the chart is initialized and the unit exits to the **NORMAL DISPLAY** if Chart Rotation and Trend Data Collect are ON. If either Chart Rotation or Trend Data Collect are OFF, after the initialization message, the unit will display **CHART ROTATION OFF** and/or **TREND DATA COLLECT OFF**, as applicable, until any key is pressed. This is a reminder that normal recording will not commence.

## 6.2 CHART CONFIGURATION

To enter Chart configuration, from the Normal Display, press the  until **SELECT** appears in the upper display line and **CHART CONFIGURATION** appears in the lower display line. If **CHART KEY DISABLED** appears in the lower display line, refer to Section 9, Enables and Passwords, for instructions to enable Chart Prompts. If **PASSWORD** appears in the lower display line, the correct "password" will need to be entered before access to the Chart Select is allowed.

1. Press the  to display **CHART SIZE**.

*Note: When changing chart size, calibration of the instrument to the chart is required. See chart calibration in Section 11.*

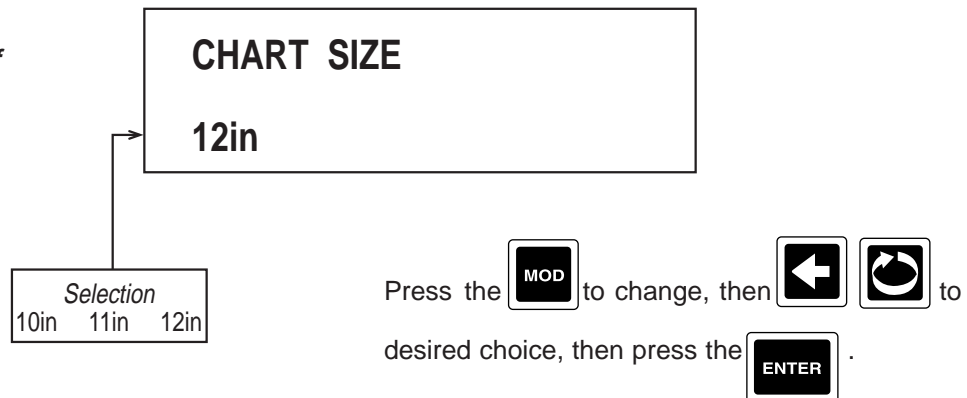

2. Press the  to advance to the next parameter, **CHART TYPE USED**.

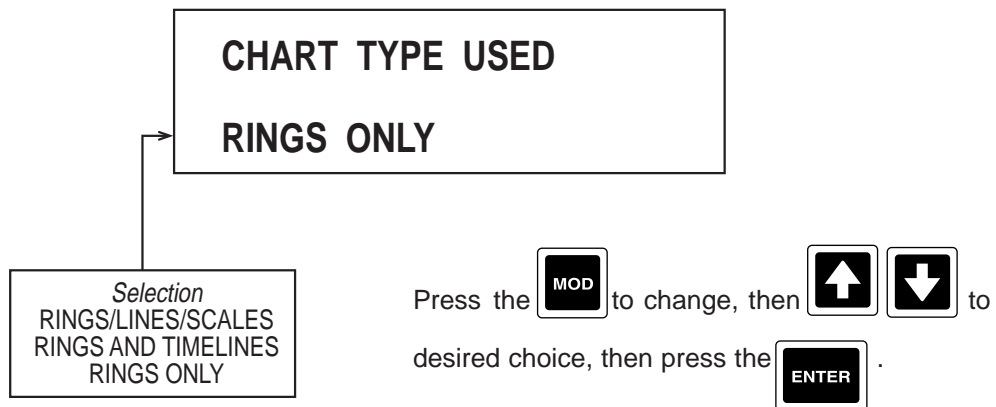



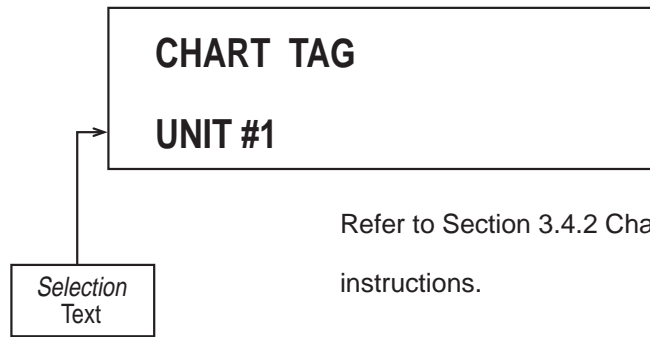



3. Press the  to advance to the next parameter, **CHART TAG**.

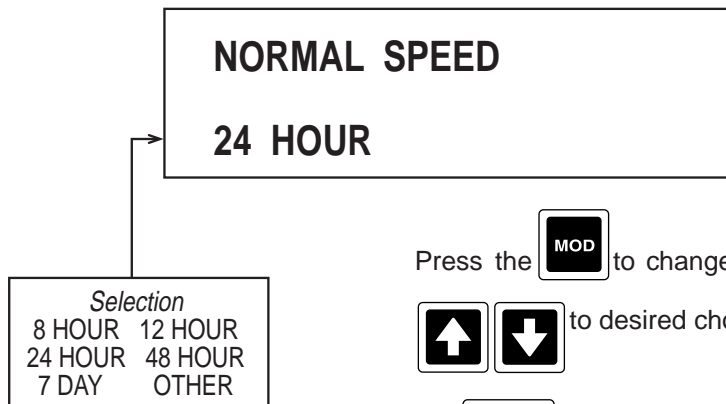

Refer to Section 3.4.2 Changing Text, Page 3-3, for instructions.







4. Press the  to advance to the next parameter, **NORMAL SPEED**.

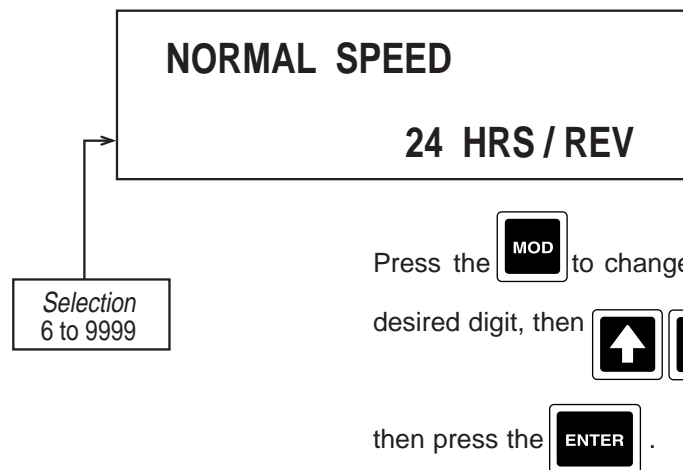

Press the  to change, then  ,   to desired choice, then press the .

5. Press the  to advance to the next parameter, **NORMAL SPEED** (only seen if NORMAL SPEED selected was OTHER).









Press the  to change, then   to desired digit, then   to desired value, then press the .



6. Press the  to advance to the next parameter, **MAJOR TIME PERIODS**.







Press the  to change, then   to desired digit, then   to desired value,

then press the .

*Selections*  
6 to 48

7. Press the  to advance to the next parameter, **MINOR TIME PERIODS**.







Press the  to change, then   to desired value, then press the .

*Selections*  
0 to 8

8. Press the  to advance to the next parameter, **BLANK MAJOR PERIODS**.



Press  the to change,   then to desired value, then press  the .

*Selections*  
0 to 48

9. Press the  to advance to the next parameter, **MAJOR LINE PEN/COLOR**.

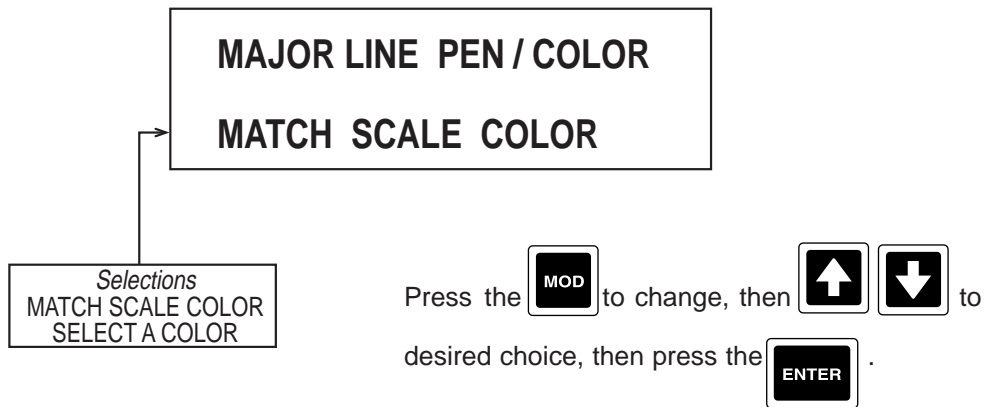

10. Press the  to advance to the next parameter, **MAJOR LINE PEN/COLOR** (only seen if MAJOR LINE PEN/COLOR selected was SELECT A COLOR).

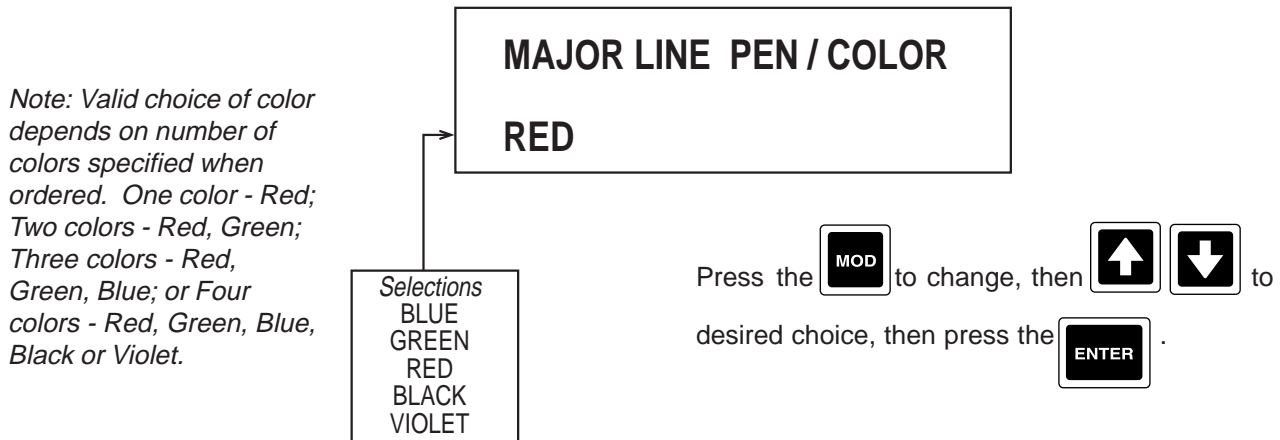

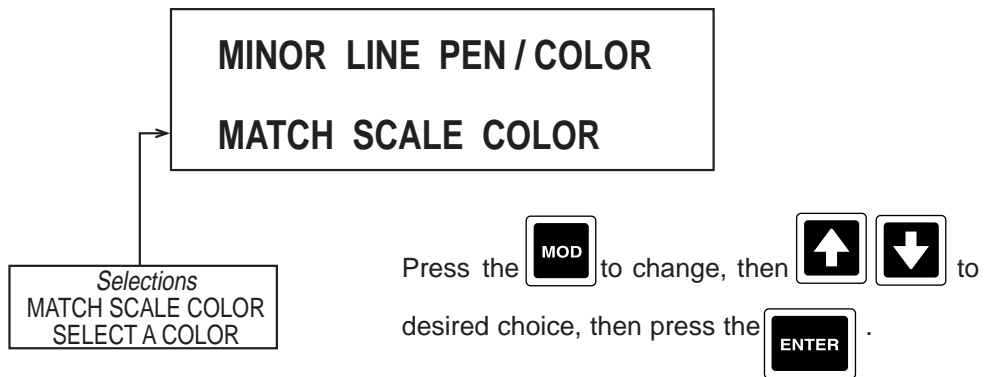

11. Press the  to advance to the next parameter, **MINOR LINE PEN/COLOR**.





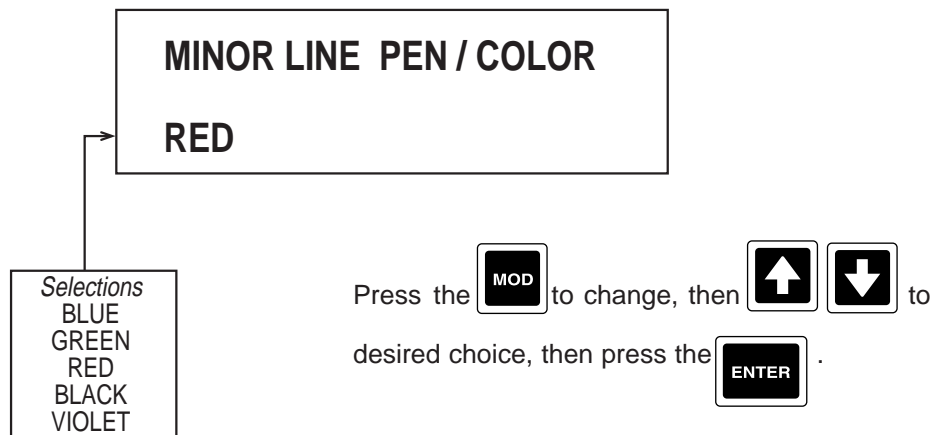

12. Press the  to advance to the next parameter, **MINOR LINE PEN/COLOR** (only seen if MINOR LINE PEN/COLOR selected was SELECT A COLOR).

*Note: Valid choice of color depends on number of colors specified when ordered. One color - Red; Two colors - Red, Green; Three colors - Red, Green, Blue; or Four colors - Red, Green, Blue, Black or Violet.*



13. Press the  to advance to the next parameter, **TIME PEN/COLOR**.



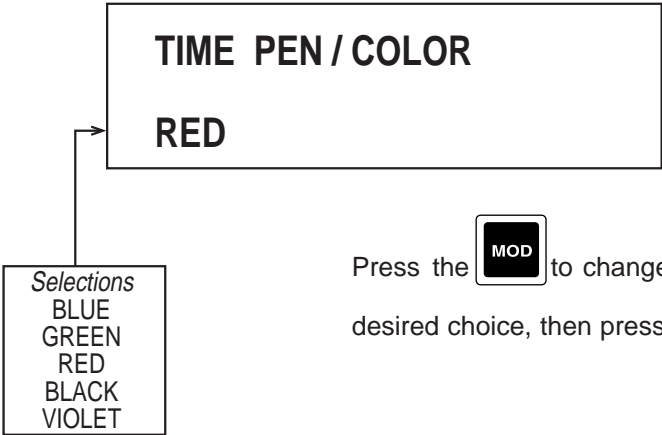

*Note: Valid choice of color depends on number of colors specified when ordered. One color - Red; Two colors - Red, Green; Three colors - Red, Green, Blue; or Four colors - Red, Green, Blue, Black or Violet.*

Press the  to change, then   to desired choice, then press the .



14. Press the  to advance to the next parameter, **DATE/PEN COLOR**.

*Note: Valid choice of color depends on number of colors specified when ordered. One color - Red; Two colors - Red, Green; Three colors - Red, Green, Blue; or Four colors - Red, Green, Blue, Black or Violet.*

Press the  to change, then   to desired choice, then press the .

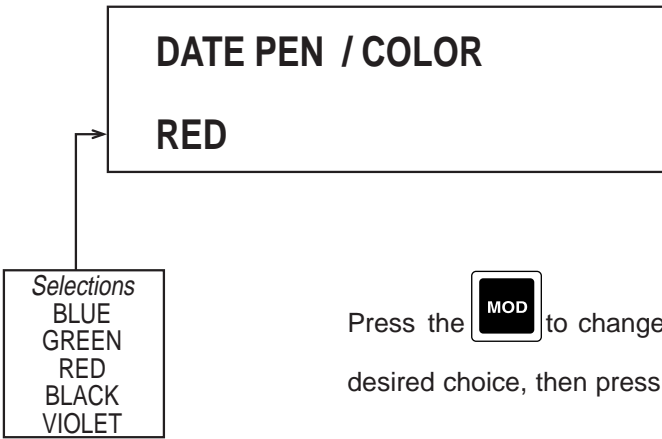

15. Press the  to advance to the next parameter, **CHART TAG PEN/ COLOR**.

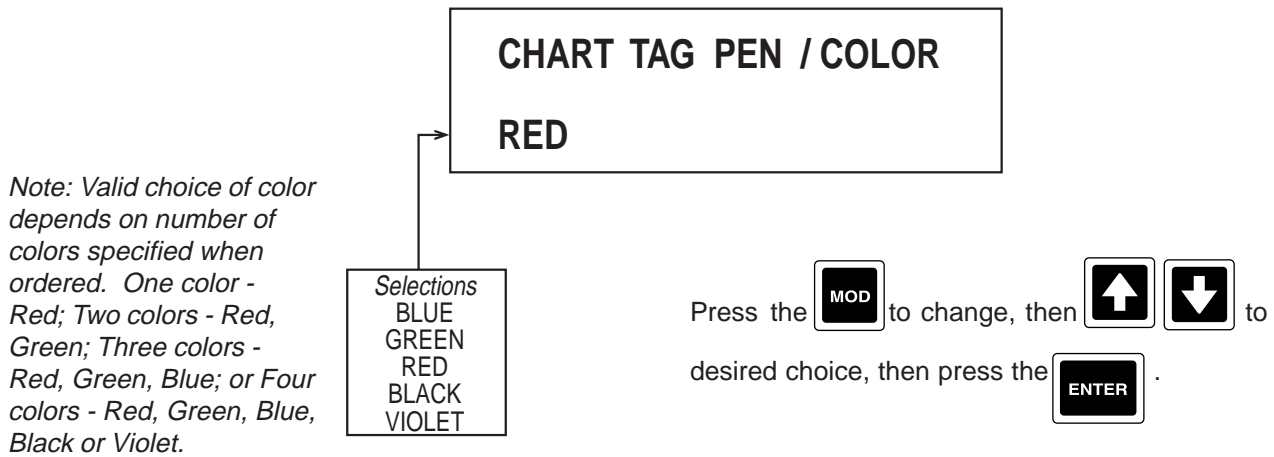

16. Press the  to advance to the next parameter, **ACTION ON NEW CHART**.

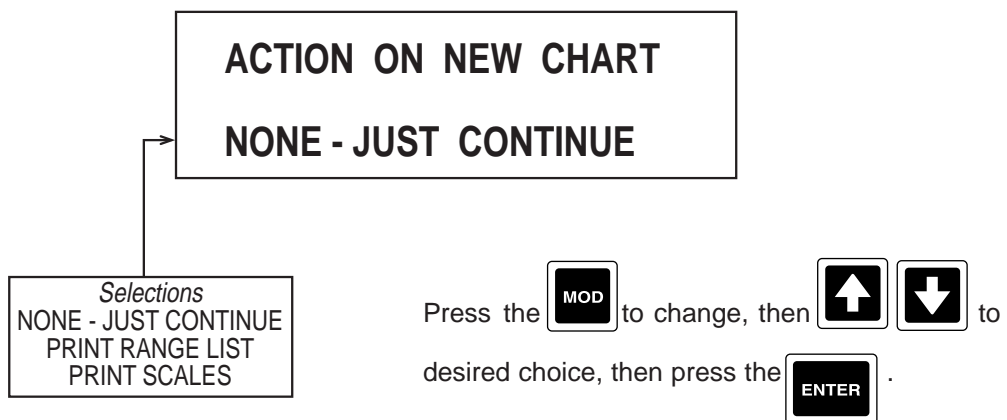

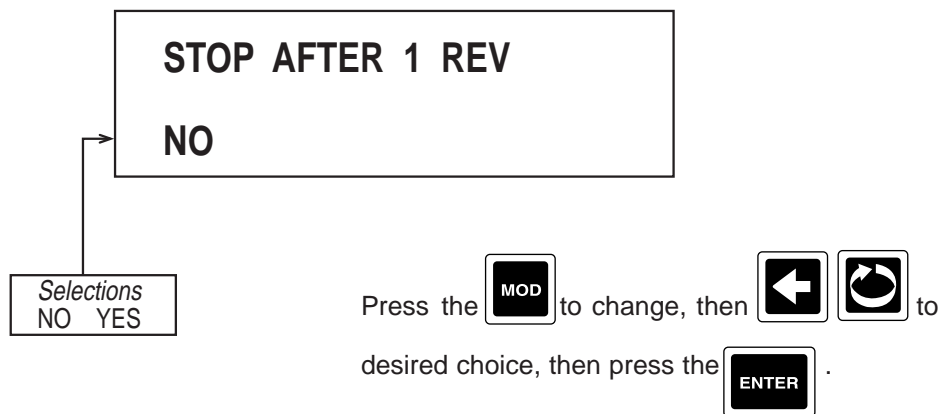

17. Press the  to advance to the next parameter, **STOP AFTER 1 REV**.





18. Press the  to advance to the next parameter, **ROTATE CHART ACTUATR**.

**ROTATE CHART ACTUATR**

**CHART ROTATION**

Press the  to change, then  ,

  to desired choice, then press

the .

*Selections*

NONE / OFF  
 ON / CONTINUOUS  
 ANY ALARM  
 ANY PROCESS ALARM  
 A11 A12 A13 A14  
 A21 A22 A23 A24  
 A31 A32 A33 A34  
 A41 A42 A43 A44  
 INSTRUMENT ALARM  
 CHART FULL  
 OP INP 1 OP INP 2  
 OP INP 3 OP INP 4  
 OP INP 5 OP INP 6  
 OP INP 7 OP INP 8  
 OP INP 9 OP INP 10  
 OP INP 11 OP INP 12  
 CHART CHANGED  
 CHART ROTATION  
 TREND DATA COLLECT  
 ALT CHART SPEED  
 DA1 DA2 DA3  
 DA4 DA5 DA6  
 DA7 DA8 DA9  
 DA10 DA11 DA12  
 DA13 DA14 DA15  
 DA16 DA17 DA18  
 DA19 DA20 DA21  
 DA22 DA23 DA24  
 PRESET 1 PRESET 2  
 PRESET 3 PRESET 4  
 TOTAL PO1 TOTAL PO2  
 TOTAL PO3 TOTAL PO4  
 TIME 1 TIME/DATE 1  
 TIME 2 TIME/DATE 2  
 TIME 1 TO TIME 2  
 TIME/DATE 1 TO 2  
 TIMER1 TIMER 2  
 TIMER 3 TIMER 4  
 SW1 SW2 SW3 SW4  
 SW5 SW6 SW7 SW8  
 COMM TRIGGER 1  
 COMM TRIGGER 2  
 COMM TRIGGER 3  
 COMM TRIGGER 4  
 F1 F2 F3 F4 F5  
 RESET MOD ENTER  
 ON THE HOUR  
 DAY OF WEEK  
 DAY OF MONTH  
 RELAY 1 RELAY 2  
 RELAY 3 RELAY 4  
 RELAY 5 RELAY 6  
 RELAY 7 RELAY 8



*Additional selections for use with controller option:*



OUTPUT 11 OUTPUT12  
 OUTPUT 21 OUTPUT22  
 OUTPUT 31 OUTPUT32  
 OUTPUT 41 OUTPUT42  
 CA1F1 CA1F2 CA1F3  
 CA1F4 CA1F5 CA1F5  
 CA2F1 CA2F2 CA2F3  
 CA2F4 CA2F5 CA2F5  
 CA3F1 CA3F2 CA3F3  
 CA3F4 CA3F5 CA3F5  
 CA4F1 CA4F2 CA4F3  
 CA4F4 CA4F5 CA4F5

19. Press the  to advance to the next parameter, **COLLECT DATA ACTUATR**.

**COLLECT DATA ACTUATR**

**CHART ROTATION**

Press the  to change, then  ,

  to desired choice, then press

the .

*Selections*

NONE / OFF  
 ON / CONTINUOUS  
 ANY ALARM  
 ANY PROCESS ALARM  
 A11 A12 A13 A14  
 A21 A22 A23 A24  
 A31 A32 A33 A34  
 A41 A42 A43 A44  
 INSTRUMENT ALARM  
 CHART FULL  
 OP INP 1 OP INP 2  
 OP INP 3 OP INP 4  
 OP INP 5 OP INP 6  
 OP INP 7 OP INP 8  
 OP INP 9 OP INP 10  
 OP INP 11 OP INP 12  
 CHART CHANGED  
 CHART ROTATION  
 TREND DATA COLLECT  
 ALT CHART SPEED  
 DA1 DA2 DA3  
 DA4 DA5 DA6  
 DA7 DA8 DA9  
 DA10 DA11 DA12  
 DA13 DA14 DA15  
 DA16 DA17 DA18  
 DA19 DA20 DA21  
 DA22 DA23 DA24  
 PRESET 1 PRESET 2  
 PRESET 3 PRESET 4  
 TOTAL PO1 TOTAL PO2  
 TOTAL PO3 TOTAL PO4  
 TIME 1 TIME/DATE 1  
 TIME 2 TIME/DATE 2  
 TIME 1 TO TIME 2  
 TIME/DATE 1 TO 2  
 TIMER1 TIMER 2  
 TIMER 3 TIMER 4  
 SW1 SW2 SW3 SW4  
 SW5 SW6 SW7 SW8  
 COMM TRIGGER 1  
 COMM TRIGGER 2  
 COMM TRIGGER 3  
 COMM TRIGGER 4  
 F1 F2 F3 F4 F5  
 RESET MOD ENTER  
 ON THE HOUR  
 DAY OF WEEK  
 DAY OF MONTH  
 RELAY 1 RELAY 2  
 RELAY 3 RELAY 4  
 RELAY 5 RELAY 6  
 RELAY 7 RELAY 8

*Additional selections for use with controller option:*

OUTPUT 11 OUTPUT12  
 OUTPUT 21 OUTPUT22  
 OUTPUT 31 OUTPUT32  
 OUTPUT 41 OUTPUT42  
 CA1F1 CA1F2 CA1F3  
 CA1F4 CA1F5  
 CA2F1 CA2F2 CA2F3  
 CA2F4 CA2F5  
 CA3F1 CA3F2 CA3F3  
 CA3F4 CA3F5  
 CA4F1 CA4F2 CA4F3  
 CA4F4 CA4F5

20. Press the  to advance to the next parameter, **CHART ROTATION**.

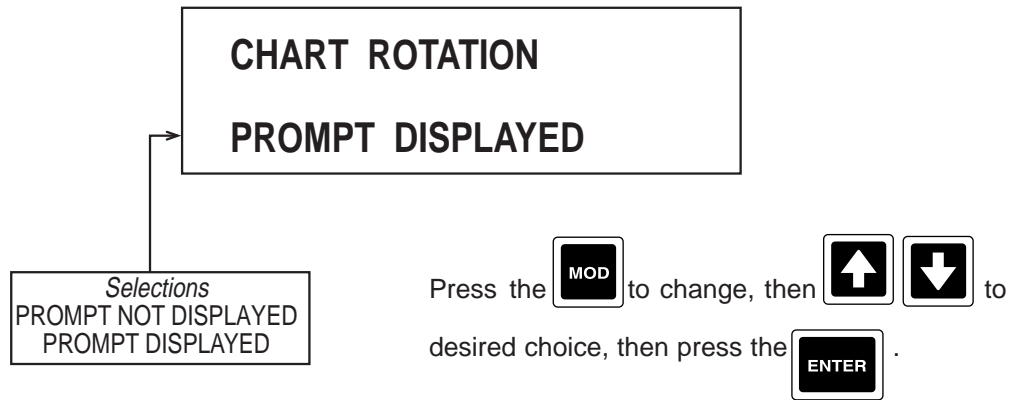

21. Press the  to advance to the next parameter, **TREND DATA COLLECT**.

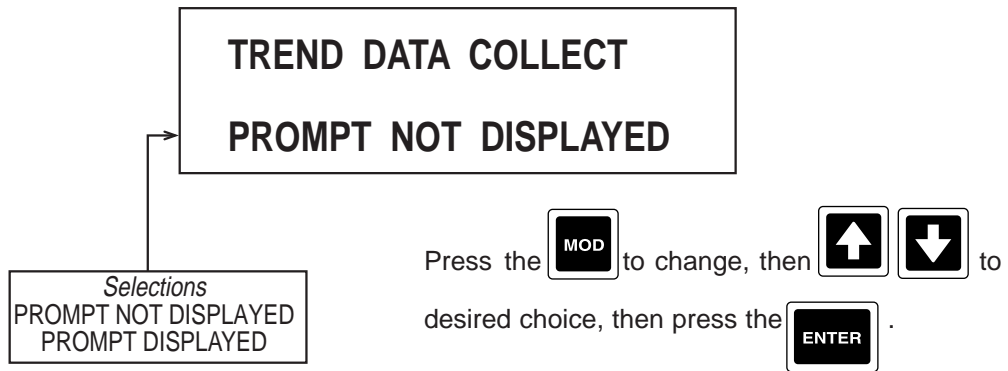

22. Press the  to advance to the next parameter, **CHART SPEED PROMPT**.

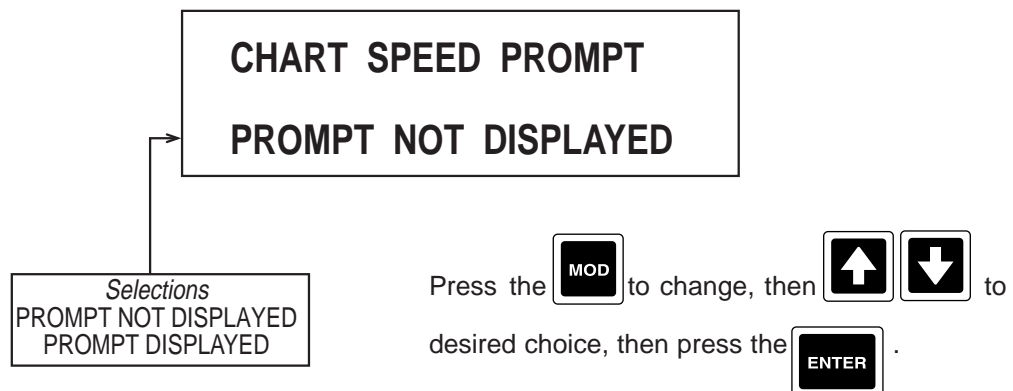

23. Press the  at any time when not in modify to exit.



# Section 7 - Alarm Settings

Selections made in Alarm Settings determine the setpoints (or RATE if RATE alarm selected) of each alarm configured in the Process Variables section of the Configuration section in System Prompts.

From the Normal Display, press the  until **ALARM SETTINGS** appears in the lower display line. If **PASS-WORD** appears in the lower display line, the correct "password" will need to be entered before access to Alarm Settings is allowed. If **ALARM SETTINGS** is not displayed, then Alarm Settings has been disabled, or **NO** alarms have been configured. Refer to Section 9, Enables and Passwords, for instructions to enable Alarm Settings.

1. Press the  to display **ALARMS FOR PV NUMBER**.

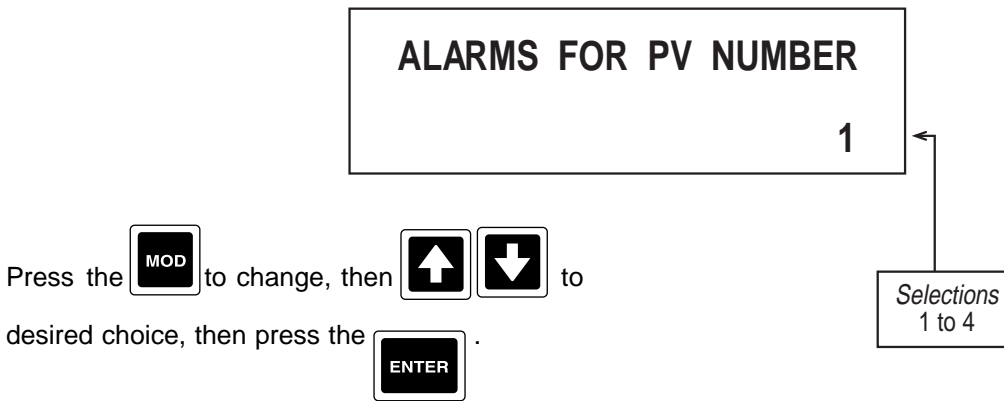

**Alarm Setpoint prompts will only appear for Alarms that have been configured. Refer to Section 4.1.5, page 4-32.**

2. Press the  to advance to the next parameter, **ALARM 1 SETPOINT**. If RATE Alarm was selected, setpoint refers to RATE.

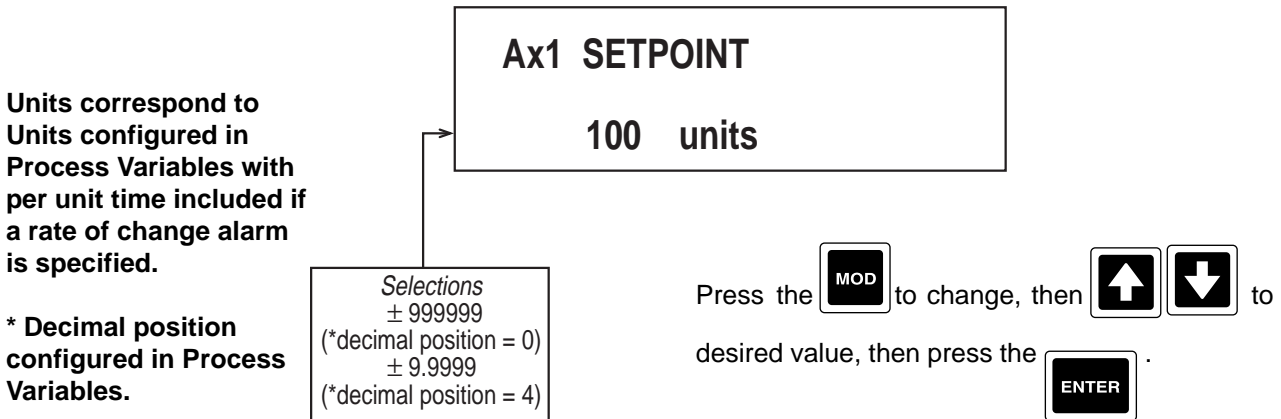



3. Press the to advance to the next parameter, **ALARM 2 SETPOINT**. If RATE Alarm was selected, setpoint refers to RATE.

Units correspond to Units configured in Process Variables with per unit time included if a rate of change alarm is specified.

• **Decimal position configured in Process Variables.**

*Selections*  
 ± 999999  
 (\*decimal position = 0)  
 ± 9.9999  
 (\*decimal position = 4)

**Ax2 SETPOINT**  
 100 units

Press the to change, then to desired value, then press the .



4. Press the to advance to the next parameter, **ALARM 3 SETPOINT**. If RATE Alarm was selected, setpoint refers to RATE.

Units correspond to Units configured in Process Variables with per unit time included if a rate of change alarm is specified.

\* **Decimal position configured in Process Variables.**

*Selections*  
 ± 999999  
 (\*decimal position = 0)  
 ± 9.9999  
 (\*decimal position = 4)

**Ax3 SETPOINT**  
 100 units

Press the to change, then to desired value, then press the .

5. Press the  to advance to the next parameter, **ALARM 4 SETPOINT**. If RATE Alarm was selected, setpoint refers to RATE.

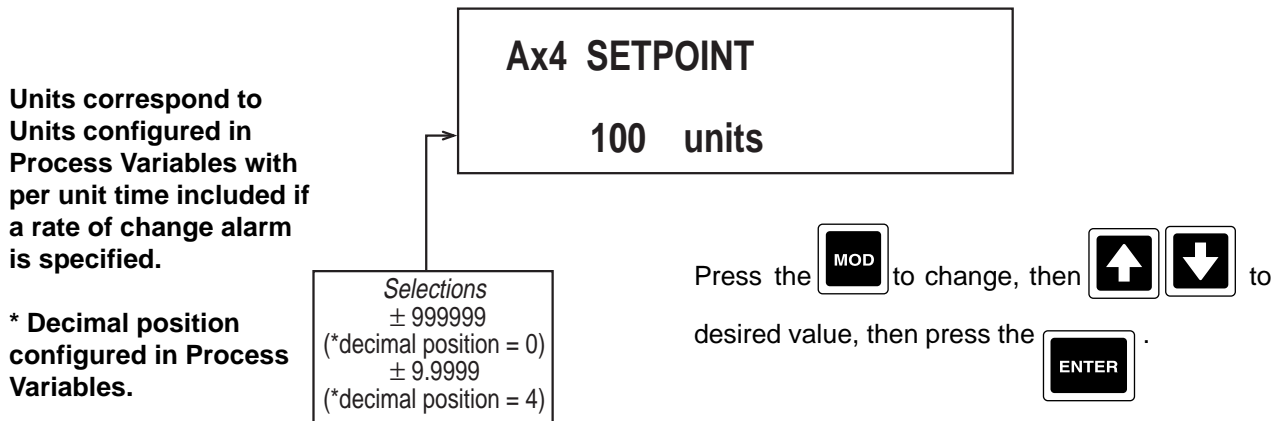

6. Press the  and the display advances to the next applicable ALARMS FOR PV NUMBER prompt. Refer to the beginning of this section, page 7-1.

## Section 8 - Action Time Settings

Action Time Settings are simply TIME/DATE settings that can be used to initiate a desired action. Selections made in Action Time Settings are used to generate actuators TIME 1, TIME/DATE 1, TIME 2, TIME/DATE 2, TIME 1 TO TIME 2, and TIME/DATE 1 TO 2.

The TIME 1 and TIME 2 actuators are TRUE when the time is equal to or greater than the TIME values during each 24 hour day, and FALSE between midnight and the TIME specified.

The TIME/DATE actuators are TRUE when the TIME and DATE are equal to or greater than the TIME and DATE values and remain TRUE after midnight.

TIME 1 TO TIME 2 is TRUE when the time is equal to or greater than the TIME 1 and less than or equal to TIME 2 during the next 24 hour period.

EXAMPLES:    TIME 1 = 8 AM                    TIME 2 = 4 PM                    8 HOURS, from 8 am to 4 pm  
                  TIME 1 = 10 PM                    TIME 2 = 6 AM                    8 HOURS, from 10 pm through midnight to 6 am



From the Normal Display, press the  until **ACTION TIME SETTINGS** appears in the lower display line. If **PASSWORD** appears in the lower display line, the correct "password" will need to be entered before access to Action Time Settings is allowed. If **ACTION TIME SETTINGS** is not displayed, then Action Time Settings has been disabled. Refer to Section 9, Enables and Passwords, for instructions to enable Action Time Settings.

Note: Each time and date is actually comprised of two or three values or choices which all must be changed/entered if any one of the parts must be changed. For example, to change a time from 9:00 PM to 9:15 PM, press MOD, then ENTER (since no change is needed to 9), change 00 to 15 and then press ENTER, then press ENTER again to leave PM as it is.

1. Press the  to display **TIME 1 TAG**.

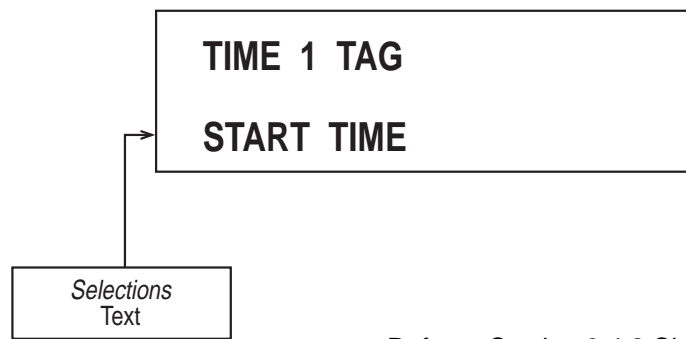

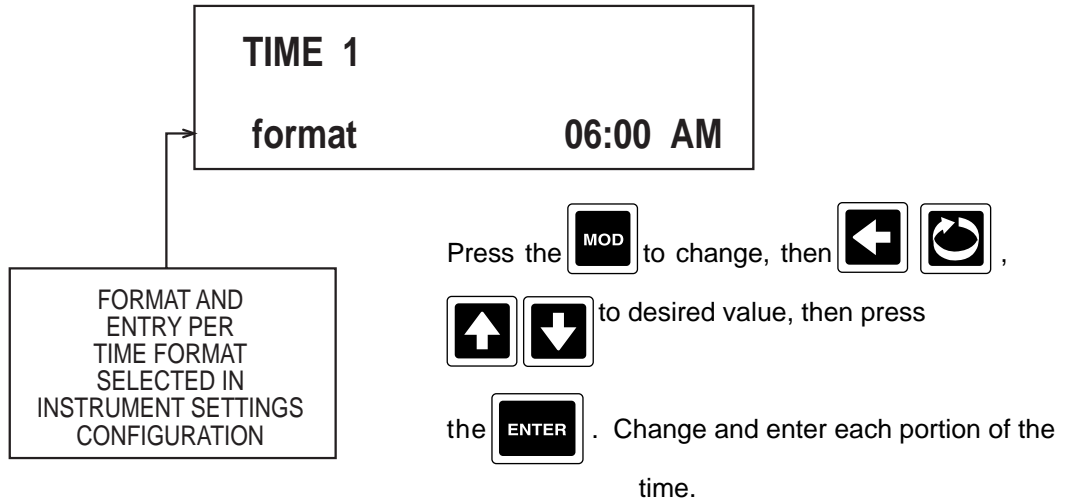

Refer to Section 3.4.2 Changing Text, page 3-3 for instructions,

2. Press the  to advance to the next parameter, **TIME 1**.

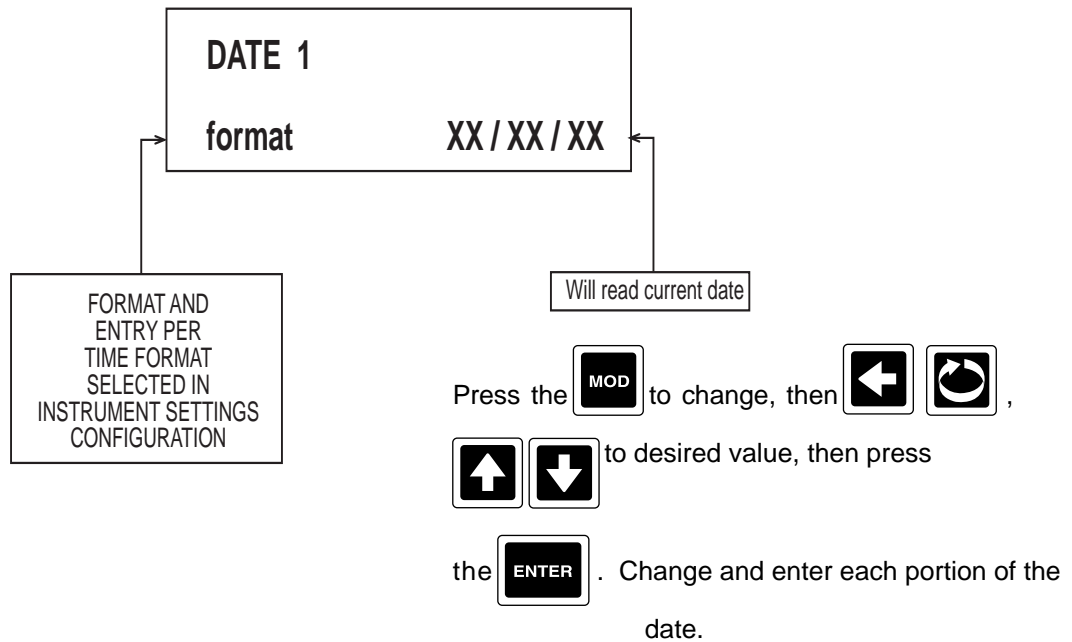

3. Press the  to advance to the next parameter, **DATE 1**.







4. Press the  to advance to the next parameter, **TIME 2 TAG**.



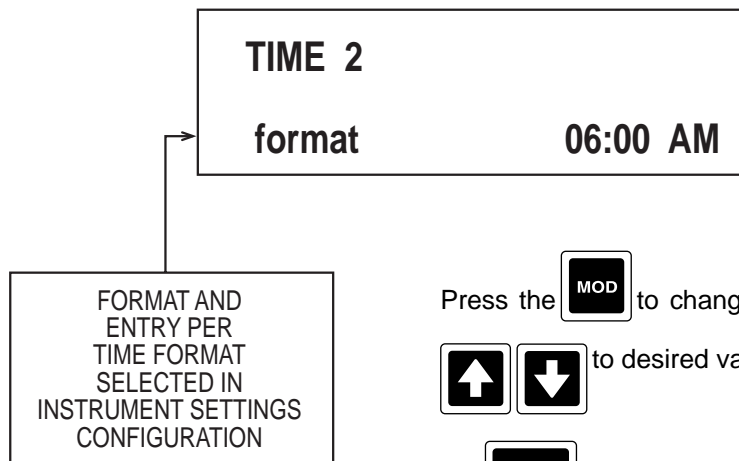

Refer to Section 3.4.2 Changing Text, page 3-3 for instructions.

5. Press the  to advance to the next parameter, **TIME 2**.





Press the  to change, then  ,

  to desired value, then press

the . Change and enter each portion of the time.

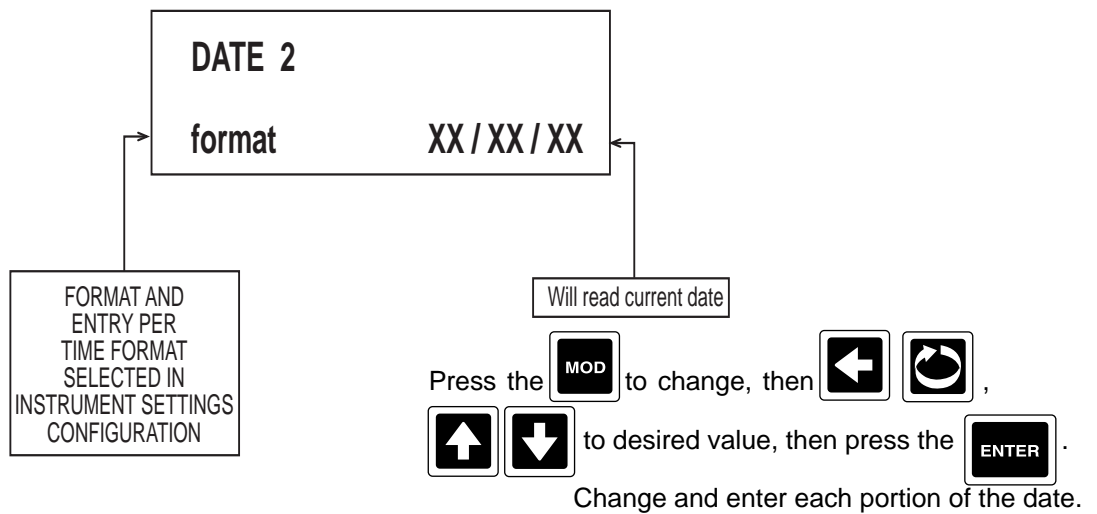
6. Press the  to advance to the next parameter, **DATE 2**.



7. Press the  to advance to the next parameter, **DAY OF WEEK ACTUATOR**.

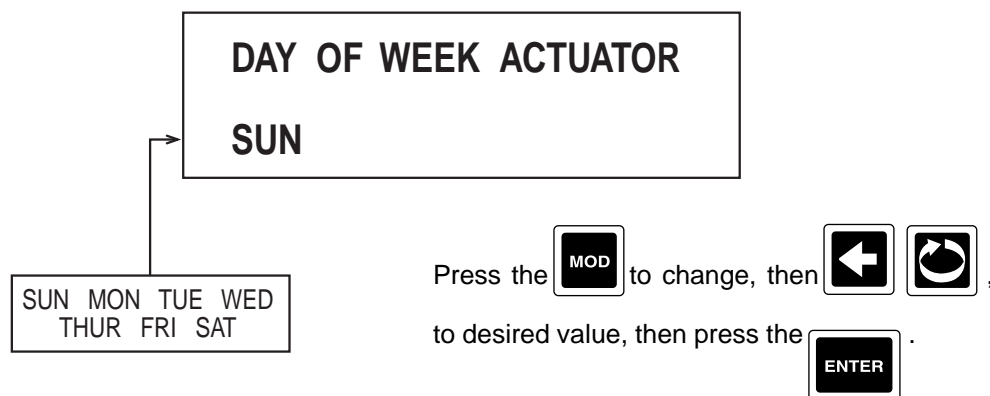

Day of Week Actuator works in conjunction with the CURRENT DAY entry under INSTRUMENT SETTINGS, page 4-76. The DAY OF WEEK ACTUATOR will be active if the day selected matches the current calendar day. For example, if today is THURSDAY and the DAY OF WEEK ACTUATOR selected is THUR, the actuator will be true until the clock calendar rolls over to FRIDAY.

8. Press the  to advance to the next parameter, **DAY OF OF MONTH ACTUATOR**.

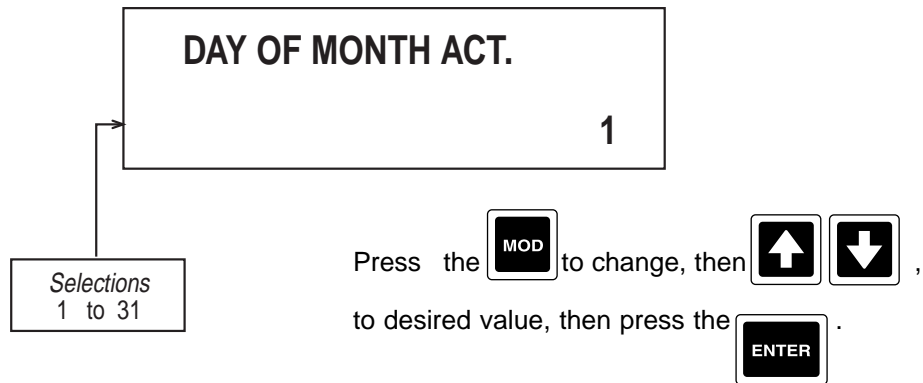

Day of Month Actuator works according to the days numerical date. For example, if today's date is the 15th and the DAY OF MONTH ACTUATOR date is selected is 15, the actuator will be active until the clock calendar rolls over to the 16th.

9. Press the  to advance to the next parameter, **TIME DISPLAY OPTION**.

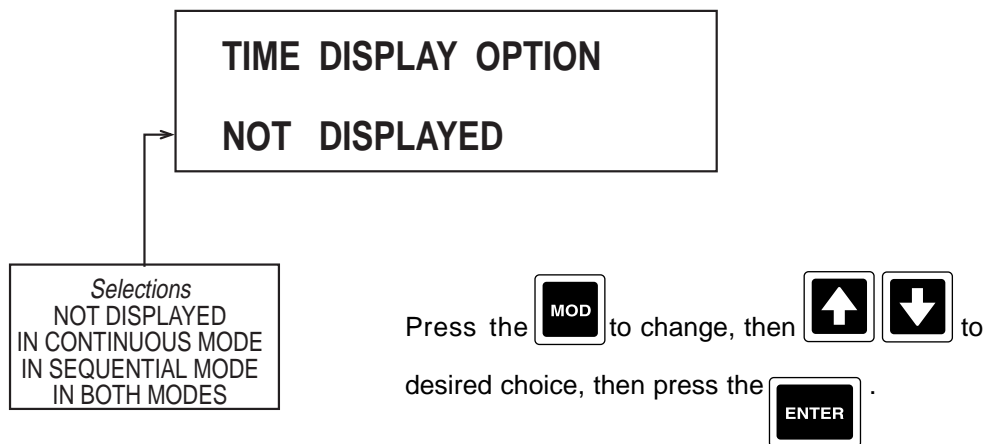

10. Press the  at any time while not in modify, to exit. Refer to the beginning of this section, page 8-1.





## Section 9 - Enables & Passwords

Enables and Passwords provides a means of enabling or disabling prompt sections and provides additional operational security with the use of 6 digit password.

If the Display prompts or Chart prompts are disabled, those prompt sections will not be accessible and DISPLAY KEY DISABLED or CHART KEY DISABLED will be displayed when the corresponding key is pressed. If other prompt sections are disabled, their corresponding access or selection prompts will not appear.

Passwords can restrict access to the Display, Chart, and System prompts, and the Enables and Passwords prompts section. If any of the passwords is set to a value other than zero, the corresponding password will be requested when the operator attempts to access that prompt section. Should a password be forgotten or misplaced, contact the factory for the master password.

From the Normal Display, press the  until **ENABLES & PASSWORDS** appears in the lower display line. If **PASSWORD** appears in the lower display line, the correct "password" will need to be entered before access to Enables & Passwords is allowed.

1. Press the  to display CHANGE ALL ENABLES.

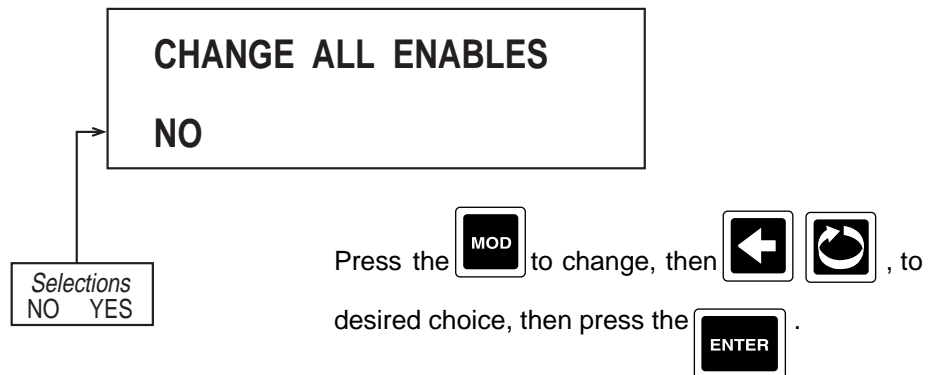

Choose YES to change all Enables at the same time.

If selection was NO, proceed to step 2.

If selection was YES:

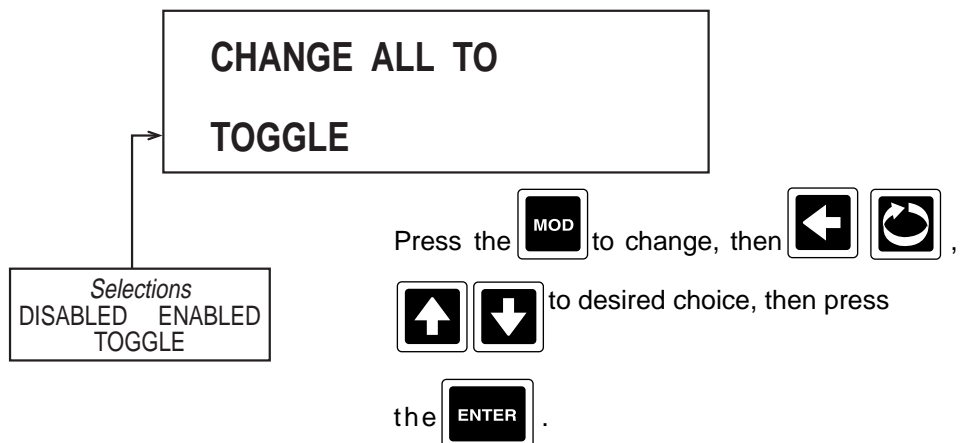

2. Press the  to advance to the next parameter, **ACTION TIME SETTINGS**.

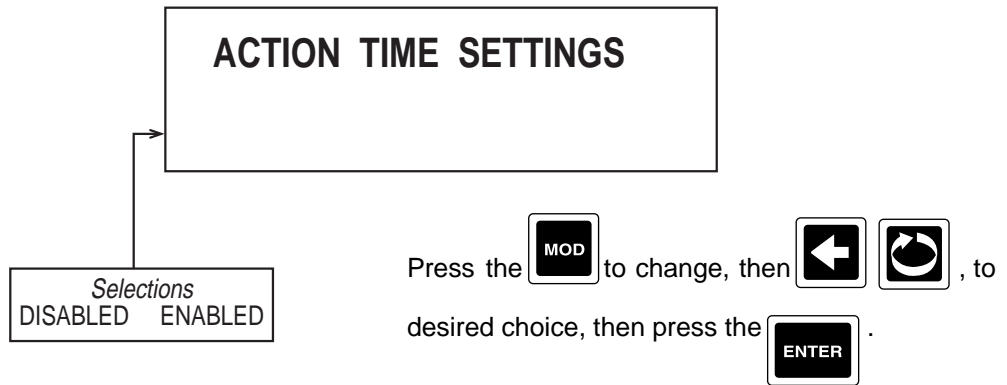

3. Press the  to advance to the next parameter, **PROFILE ENTRY (Only on Profiles)**.

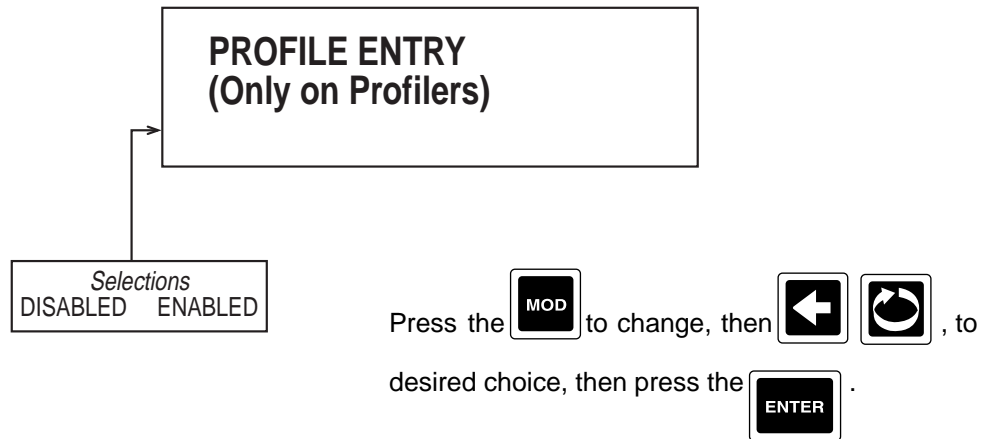

4. Press the  to advance to the next parameter, **PROFILE CONTROL (Only on Profiles)**.

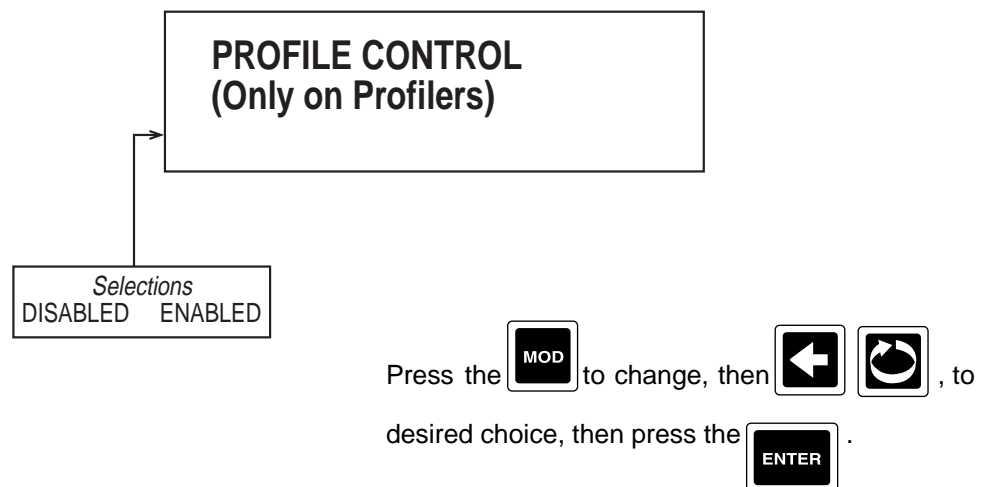

5. Press the  to advance to the next parameter, **ALARM SETTINGS**.

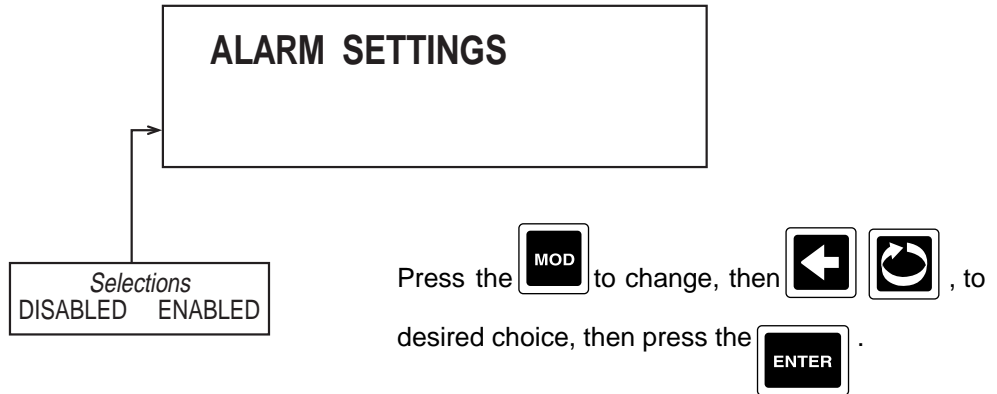

6. Press the  to advance to the next parameter, **TUNING PARAMETERS** (only seen if CONTROLLER).

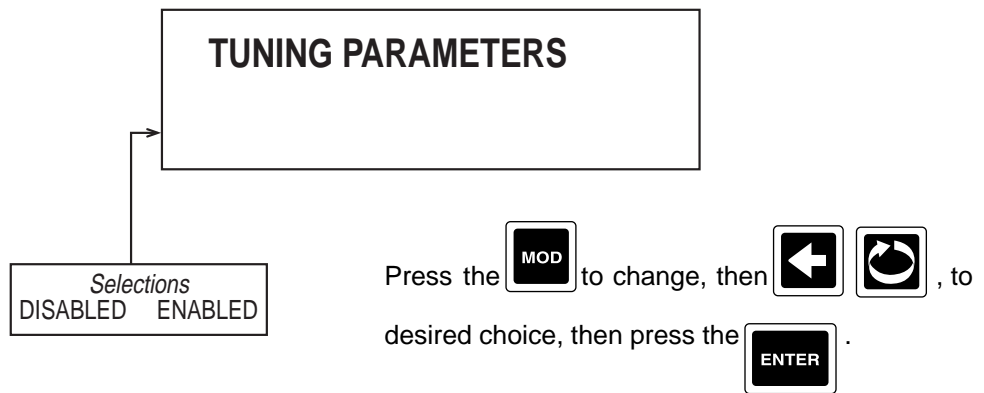

7. Press the  to advance to the next parameter, **SETPOINT CHANGES** (only seen if CONTROLLER).

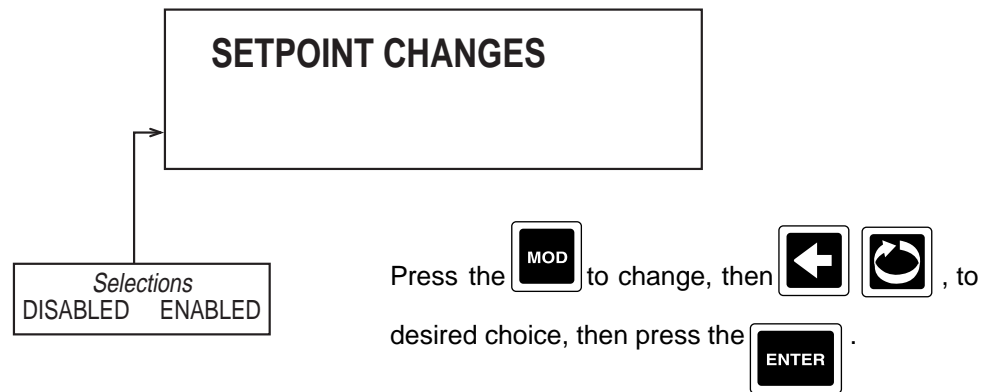

8. Press the  to advance to the next parameter, **CONFIGURATION**.

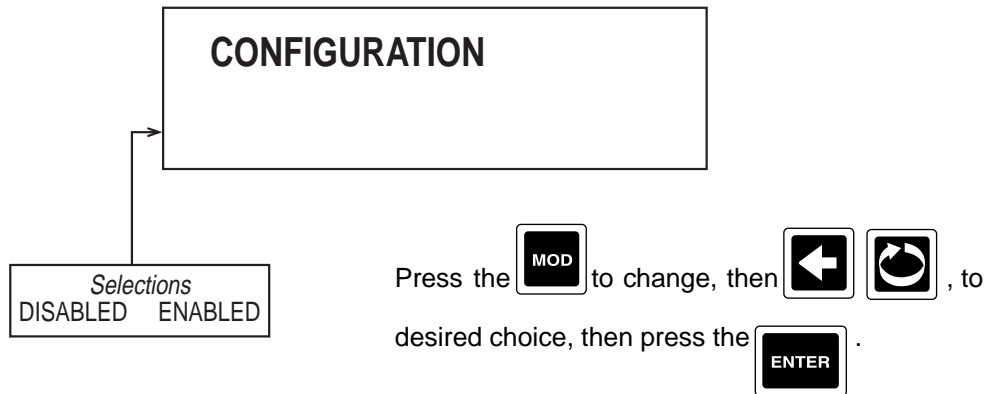

9. Press the  to advance to the next parameter, **DERIVED ACTUATORS**.

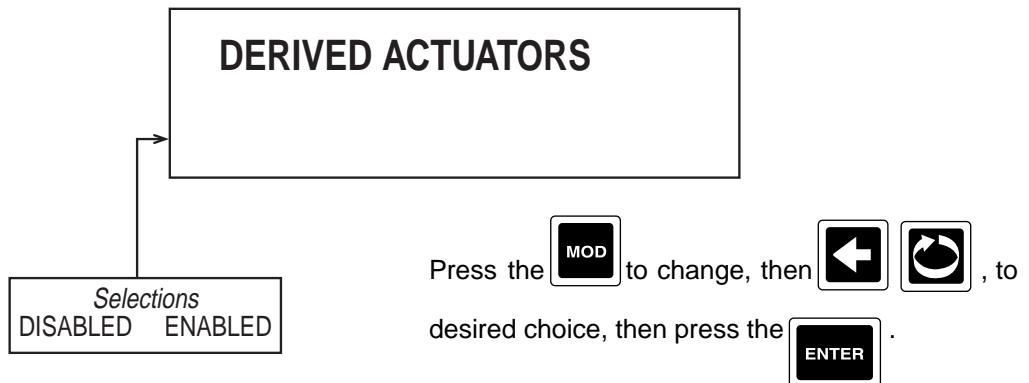

10. Press the  to advance to the next parameter, **OPERATOR INPUTS CONFIGURATION**.

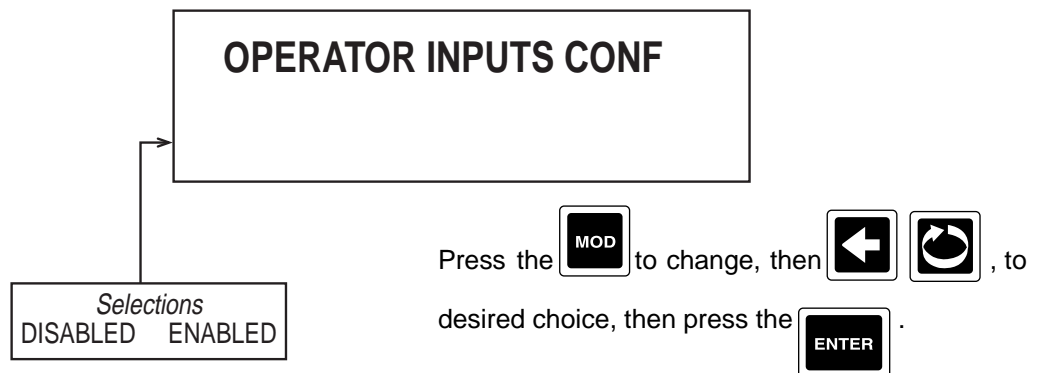

11. Press the  to advance to the next parameter, **OPERATOR MESSAGES**.

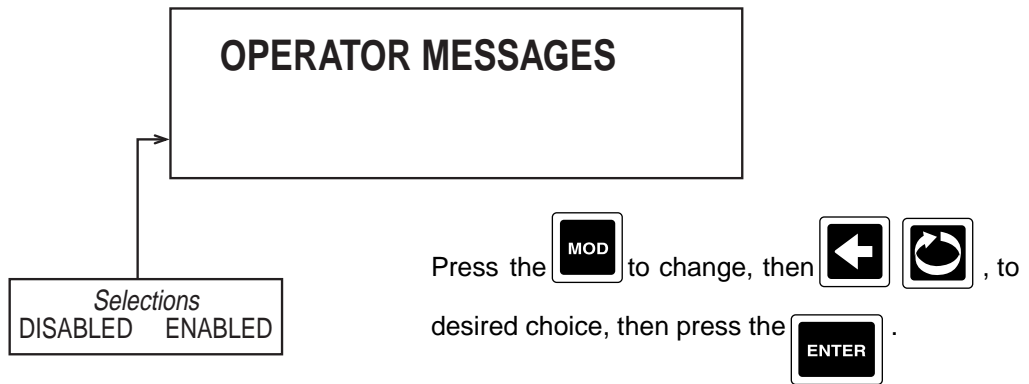

12. Press the  to advance to the next parameter, **CHART MESSAGES**.

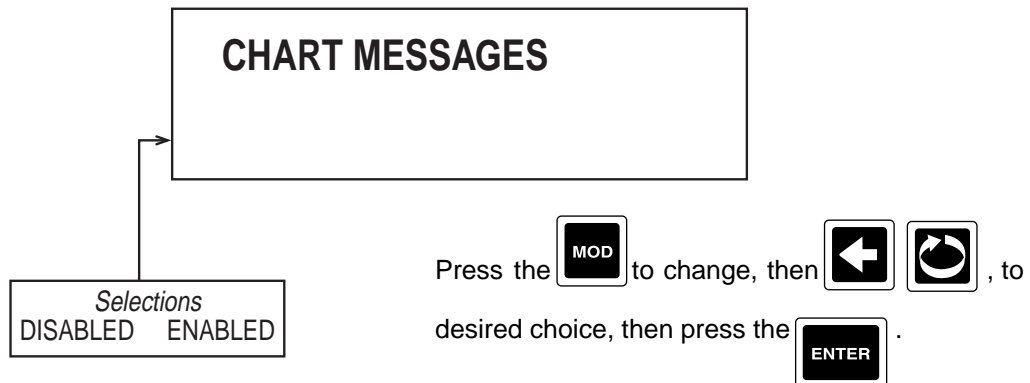

13. Press the  to advance to the next parameter, **SIMULATED VARIABLES**.

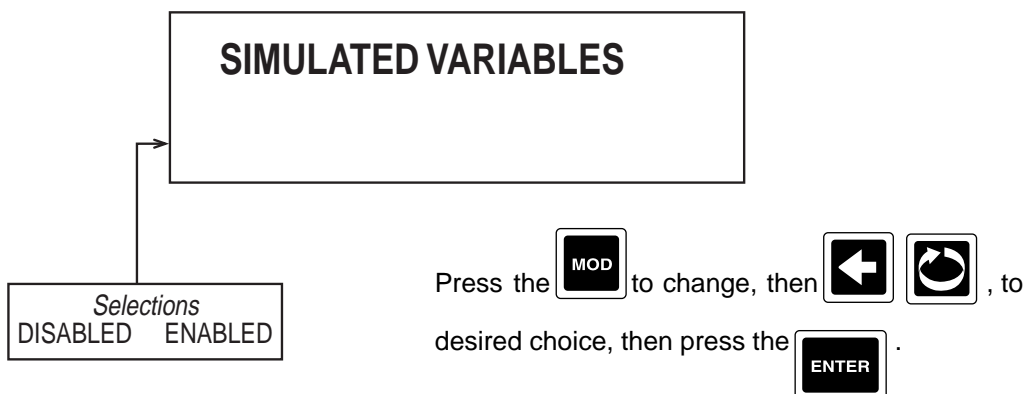

14. Press the  to advance to the next parameter, **TEST**.

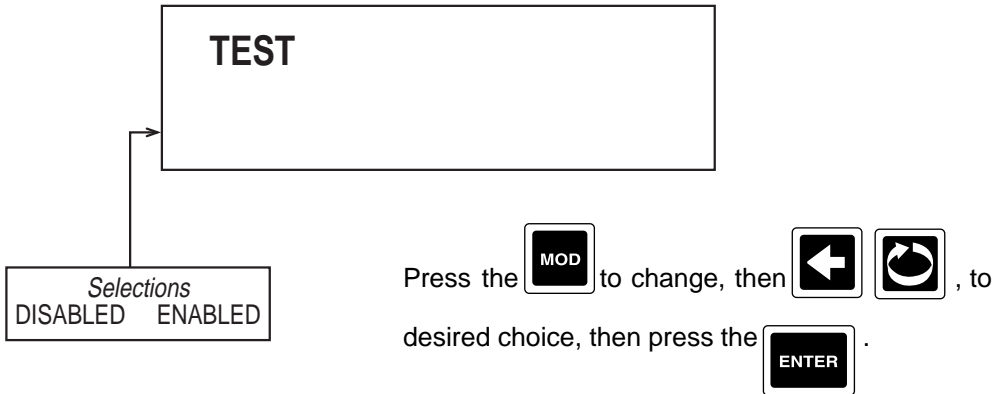

15. Press the  to advance to the next parameter, **CALIBRATION**.

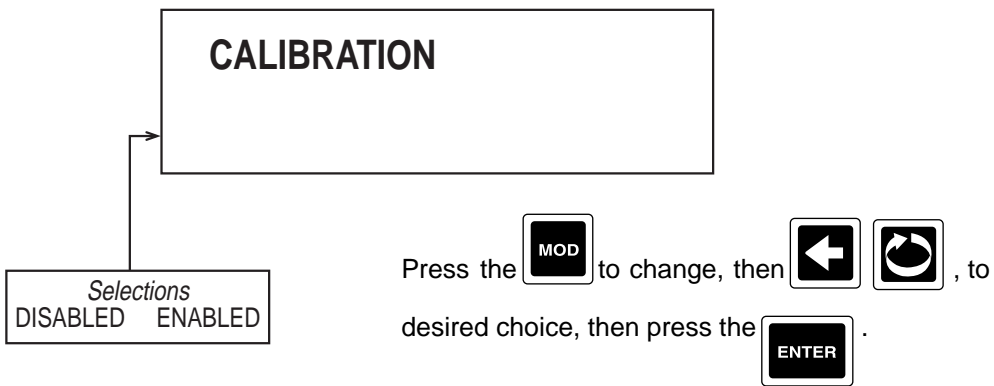

16. Press the  to advance to the next parameter, **CHART PROMPTS**.

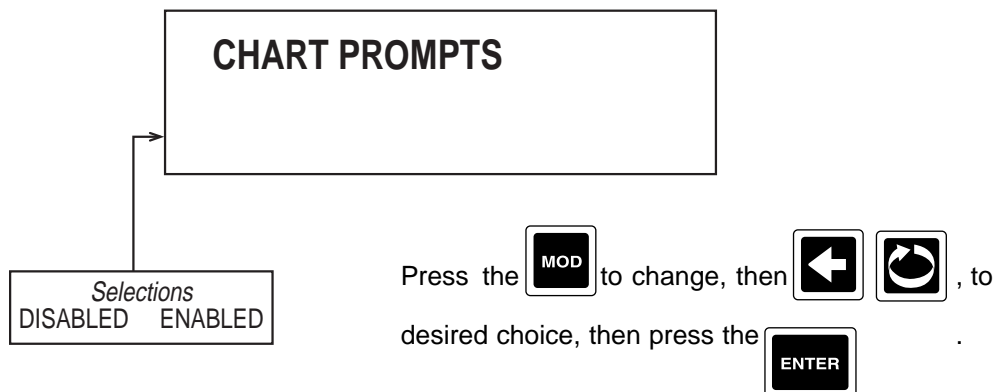

17. Press the  to advance to the next parameter, **CHART CONFIGURATION**.

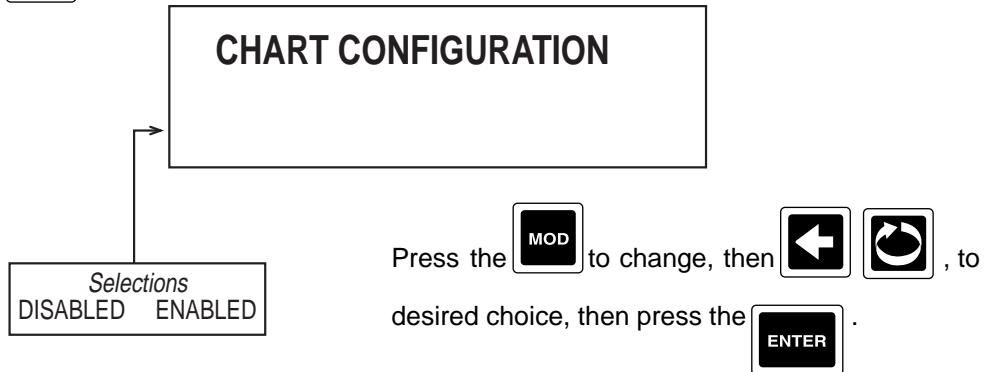

18. Press the  to advance to the next parameter, **DISPLAY PROMPTS**.

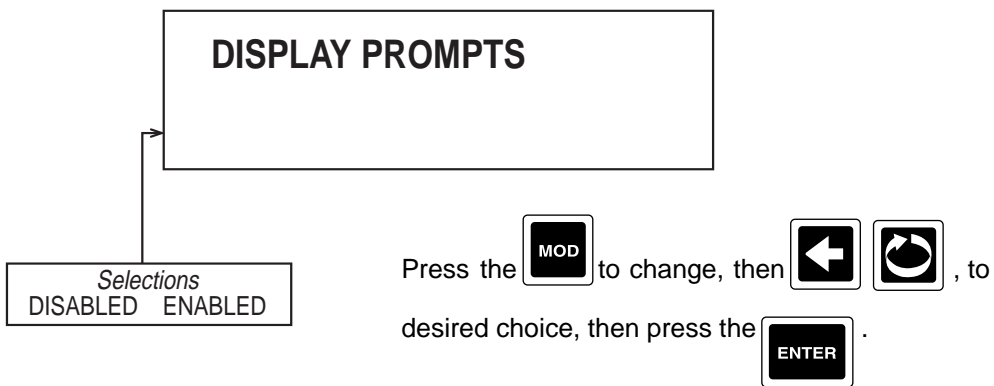

19. Press the  to advance to the next parameter, **OPERATOR INPUTS**.

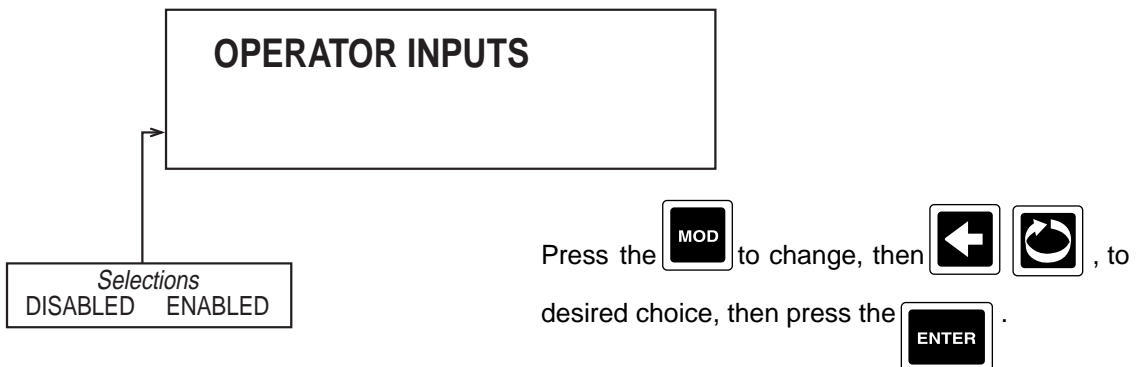

20. Press the  to advance to the next parameter, **CONTROL STATE ACCESS** (only seen if CONTROL-  
LER)

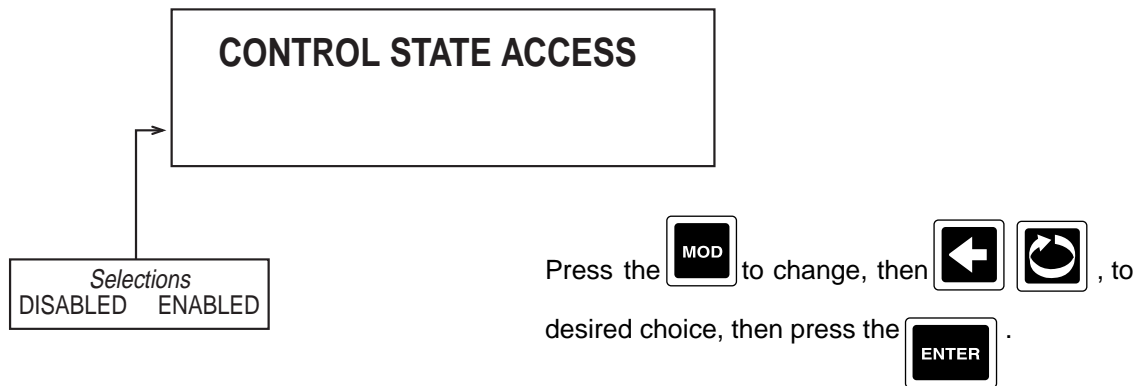

21. Press the  to advance to the next parameter, **SYSTEM PROMPTS PASSWORD.**

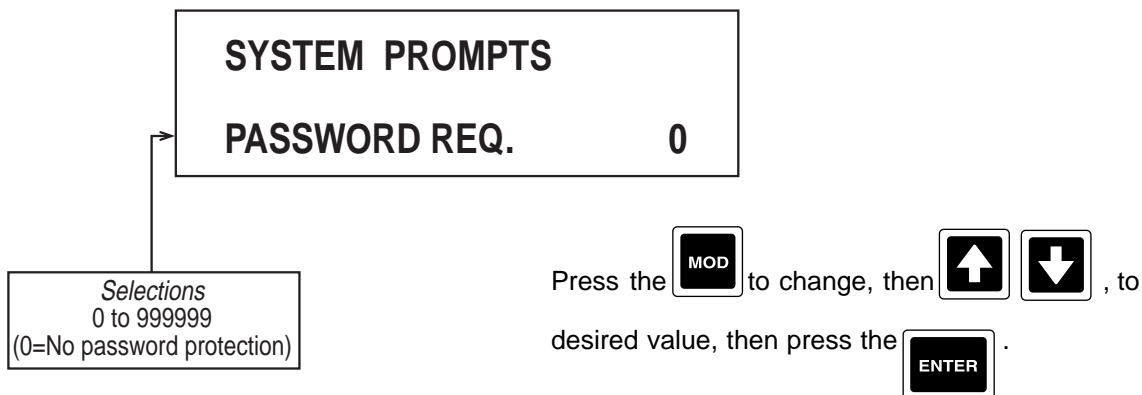



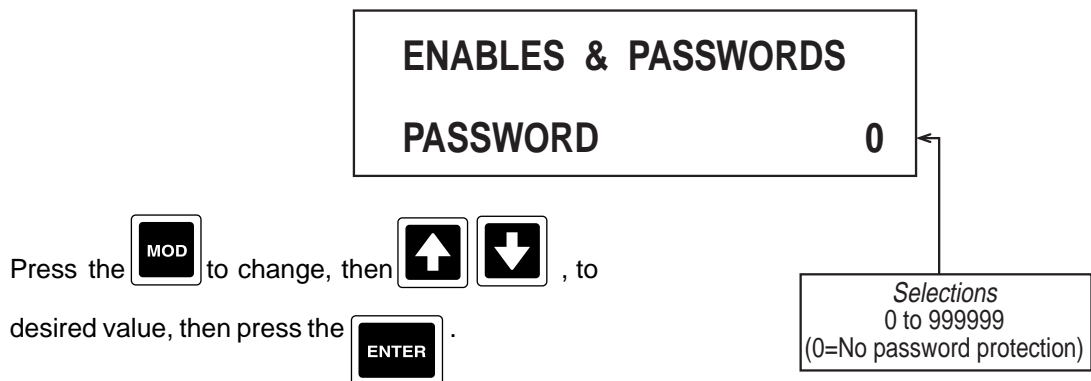

22. Press the  to advance to the next parameter, **ENABLES & PASSWORDS PASSWORD.**





23. Press the  to advance to the next parameter, **CHART PROMPTS PASSWORD**.





<b>CHART PROMPTS</b>
<b>PASSWORD</b> 0

Press the  to change, then   , to desired value, then press the  .

*Selections*  
0 to 999999  
(0=No password protection)

24. Press the  to advance to the next parameter, **DISPLAY PROMPTS PASSWORD**.

<b>DISPLAY PROMPTS</b>
<b>PASSWORD</b> 0

Press the  to change, then   , to desired value, then press the  .

*Selections*  
0 to 999999  
(0=No password protection)

25. To exit, press the  .

---

## Section 10 - Test

Test describes all possible diagnostic tests built into the recorder.



From the Normal Display, depress the  until **TESTS** appears in the lower display line. If **PASSWORD** appears in the lower display line, the correct "password" will need to be entered before access to Test is allowed. If **TESTS** is not displayed, then Test has been disabled. Refer to Section 9, Enables and Passwords, for instructions to enable Test.

A list of available tests and their purpose are shown in Table 10-1.

**TABLE 10-1 AVAILABLE TEST**



Relays	Used to verify that all LEDs, Relays and/or Solid State Relay Drivers (SSRD) are working correctly.
Display	Used to verify the display is functional.
Keypad	Used to verify that all keys are functional.
LEDs	Used to verify that the functionality of the LEDs.
Chart Demonstration	Used to demonstrate chart capabilities. <b>CAUTION:</b> When this test is initiated, any parameter values previously programmed in Chart Configuration and Recorders are replaced with the demonstration values.
A/D Reset Counter	Displays the number of times the A/D counter has been reset. <b>FACTORY USE ONLY!</b>
A/D Raw Hex Counts	Displays raw counts for inputs and grounds. <b>FACTORY USE ONLY!</b>
Calibrated Input Values	Displays calibrated input values for inputs and grounds. <b>FACTORY USE ONLY!</b>
mA Output	Used to verify the mA Output is functional.

---

## 10.1 RELAY TEST

Allows the operator to verify that the LEDs, Relay and/or SSRD output(s) is/are working. A Volt/Ohm meter will be required to test the output.

### Step 1

With **RELAY** in the lower display line, depress the  and **INITIATE RELAY TEST** appears in the upper display line and **NO** appears in the lower display line. Depress , select YES, depress  to perform the test.

### Step 2

**TEST IN PROCESS** appears in the upper display line, LED 1 will be lit and Relay 1 will be energized or SSRD 1 will be on. For SPDT relays, connect the meter across the NO. and COM output terminals in the ohm scale. The meter should read continuity with the relay on and infinity when the relay is off. For SSRD outputs, connect the meter across the output terminals in the Volt DC scale. The meter should read +5 VDC when the SSRD is on and 0 VDC when the SSRD is off.

### Step 3

When each depression of the  advances through each available Relay and/or SSRD. All eight LEDs should light, one after the other, as all 8 are always present.

### Step 4

To exit the test, depress the .

---

## 10.2 DISPLAY TEST

Allows the operator to verify that all dots in the VFD are working. No test equipment is required to perform this test.

### Step 1

With **DISPLAY** in the lower display line, depress the  and **INIT DISPLAY TEST** appears in the upper display line and **NO** appears in the lower display line. Depress , select YES, then depress  to perform the test.

### Step 2

All dots in the vacuum fluorescent display will light. With each successive depression of the , the display will show 2 lines of characters, then all dots being lit, then characters, etc..

### Step 3



To exit the test, depress  when the lines of characters are displayed. The instrument will return to the normal display.

---

### 10.3 KEYPAD TEST

Allows the operator to verify that the keypad is functional. No test equipment is required to perform this test.

#### Step 1

With **KEYPAD** in the lower display line, depress the  and **INITIATE KEYPAD TEST** appears in the upper display line and **NO** appears in the lower display line. Depress  , select YES, then depress  to start the test.

#### Step 2

**THE KEY PRESSED WAS** appears in the upper display line and **ENTER KEY** appears in the lower display line. With each depression of a key (**EXCEPT ESC**), the name of that key will appear in the lower display line. **The ESC key will exit this test.**

#### Step 3



To exit this test, depress the  key and the instrument will return to the normal display.

---

### 10.4 LED TEST

Allows the operator to verify that the LEDs are functional. No test equipment is required to perform this test.



#### Step 1

With **LED** in the lower display line, depress the  and **INITIATE LED TEST** appears in the upper display line and **NO** appears in the lower display line. Depress the  , select YES, then depress  to start the test.

#### Step 2

**LED TEST PROCEDURE** will appear in the upper display line and **PRESS ENTER TO START** will appear in the lower display line. Depress  , and **PRESS ENTER TO INDEX** appears in the lower display line.

#### Step 3

Depress  and LED 1 should light. With each successive depression of  , the LEDs turn ON,

then OFF in order, 1 through 8, then all ON, then all OFF. If  is depressed again, the sequence begins again.

#### Step 4

To exit the test, depress the  and the instrument will return to the normal display.

---

## 10.5 CHART DEMONSTRATION

Allows the user to demonstrate the chart capabilities. **CAUTION:** When this "TEST" is initiated, any parameter values previously programmed will be replaced with the demonstration values.

### Step 1

With **CHART DEMONSTRATION** in the lower display line, depress the , **INITIATE CHART DEMO** appears in the upper display line and **NO** appears in the lower display line.

### Step 2

Depress , select **YES**, depress . Instrument returns to Normal Display.

### Step 3

Depress , **CHANGE CHART** appears in the upper display line, select **YES**, select **YES** again for **START NEW CHART**.

### Step 4

Chart demo begins.

### Step 5



To exit or quit demo, depress  to **CHART ROTATION** and select OFF.

---

## 10.6 mA OUTPUT TEST

Allows the operator to verify that the current output(s) is/are functioning properly. A milliamp meter is required to perform this test.



### Step 1

With **mA OUTPUT** in the lower display line, depress the  and **INITIATE mA OUT TEST** appears in the upper display line and **NO** appears in the lower display line. Depress , select **YES**, then depress  to start the test.

### Step 2

**SELECT mA OUTPUT** will appear in the upper display line and **1 2 3 4** will appear in the lower display line. To select output to be tested, depress the key directly under the desired output number.

### Step 3

Connect the milliamp meter across the output terminals being tested. Be sure to observe proper polarity when connecting the meter, terminal 1 is positive. Use the   to increase or decrease the current output in 1 mA steps, from 0 to 22 mA.

Step 4

The current output reading should be equal to the displayed value.

Step 5

To exit the test, depress the



and the instrument will return to the normal display.

---



## Section 11 - Calibration

Calibration describes all possible field calibration procedures for the recorder as well as methods of invoking default program and calibration values. The procedures described include the input and range calibration as well as chart calibration.



From the Normal Display, press the  until **CALIBRATION** appears in the lower display line. If **PASSWORD** appears in the lower display line, the correct "password" will need to be entered before access to Calibration is allowed. If **CALIBRATION** is not displayed, then Calibration has been disabled. Refer to Section 9, Enables and Passwords, for instructions to enable Calibration.



Press the  to display **CALIBRATION** in the upper display and **SOLENOID ADJUSTMENT** in the lower display line. Press the  to advance the lower display to other calibrations available.



The table below (Table 11-1) lists the calibration routines. All instruments are calibrated prior to shipment from the factory.

**CAUTION: Do not attempt any calibration without the proper test equipment that meets or exceeds the specifications listed below.**

RTD Inputs:	Decade box with 0.01% resolution or equivalent OR 100 ohm $\pm$ 0.01% AND 277 ohm $\pm$ 0.01%.
CURRENT Inputs:	0.00 mA to 20.00 mA Source $\pm$ 0.01 mA DC
* TC or 0/25 mV Inputs:	0.00 mV to 25.00 mV Source $\pm$ 0.01 mV DC
*TC or 0/100 mV Inputs:	0.00 mV to 100.00 mV Source $\pm$ 0.01 mV DC
0 to 1 VOLT Inputs:	0.00 V to 1.00 V $\pm$ 0.01 V DC
0 to 10 VOLT Inputs:	0.00 V to 10.00 V $\pm$ 0.01 V DC
:	

\* For TC only - one (1) mercury thermometer  $\pm$  .25 deg. C or equivalent and a Type X thermocouple; X = type of TC input being calibrated.

### **TABLE 11-1 CALIBRATION ROUTINES**

Input Calibration	Performs calibration of all input sources
Parameter Defaults	Invokes the default values for all program parameters
Chart Calibration	Performs calibration of the pen to the chart. It is recommended that chart calibration be performed whenever the chart size is changed.
Milliamp Outputs	Performs calibration of current outputs
Solenoid Adjustment	Allows calibration of the current through the solenoid driver and is adjusted at the factory to maximize life of the solenoid actuators. This procedure would not normally need to be performed in the field.
Calibration Defaults	Invokes the calibration default values.



## 11.1 INPUT CALIBRATION

This routine allows for the calibration of all input channels and all input types.





### **Important Notes:**

1. The calibration information is stored on each input board for all input types in an Electrically Erasable Programmable Read Only Memory (EEPROM). The instrument and every input board supplied to the field is shipped from the factory calibrated for each input type.
2. Recalibration should only be performed if it is determined that the Recorder is outside of the operating specifications for the instrument itself (without considering the input source). Input Correction should be used to correct for Input Signal inaccuracies.
3. If recalibration is necessary, it is only required for the particular input type and range that is being used.



### Step 1

With **INPUT CALIBRATION** in the lower display line, press the  to enter the Input Calibration. The upper display line will display **CALIBRATE INPUT** and the lower display line will display **IV1**. If an input other than input 1 is to be calibrated, use the MOD, LEFT, SCROLL, UP or DOWN as required to select the proper input number, then press the .

### Step 2

Press the  and the upper display line will display **IVx CAL BOARD TYPE** (x = input number selected) and the lower display line will display **TC/VOLT**. If the input to be calibrated is TC/VOLT/mA, press the  to move to the next step. If the input to be calibrated is RTD, press , then F5, then .

### Step 3

**IVX CAL WHAT RANGE** should be in the upper display line and **OFF - NO INPUT** should be in the lower display line. To calibrate, press the , then UP, DOWN, LEFT, SCROLL as required to select the input range to be calibrated per Table 11-2, then press .

**TABLE 11-2 RANGE SELECT**

Select	IF	Input Is
TC WIDE		TC and not T, R, S, or B
TC NARROW		TC and other than above
RTD		RTD
mA		CURRENT
25 mV		mV and maximum is 25 mV or less
100 mV		mV and maximum is 100 mV or less
1 VOLT		Volt and maximum is 1 Volt or less
10 VOLT		Volt and maximum is 10 Volts or less



**Step 4**

Be sure that the jumpers on the Input Board for the Input being calibrated are positioned as shown in Table 11-3, and Figure 11-1 or Table 11-3A and Figure 11-1A, depending on which circuit board is fitted.

**TABLE 11-3 INPUT BOARD JUMPER POSITIONS**

	INPUT 1, 3, 5, 7						INPUT 2, 4, 6, 8					
	JU1	JU2	JU3	JU7	JU11	JU15	JU4	JU5	JU6	JU8	JU12	JU16
TC NARROW	U	L	P	R	R	P	U	R	P	R	L	P
TC WIDE	U	L	P	M	R	P	U	R	P	M	L	P
RTD	P	L	U	L	L	P	P	R	U	L	R	P
mA	U	L	P	L	R	U	U	R	P	L	L	U
25 mV	U	L	P	R	R	P	U	R	P	R	L	P
100 mV	U	L	P	M	R	P	U	R	P	M	L	P
1 VOLT	U	L	P	L	R	P	U	R	P	L	L	P
10 VOLT	U	L	D	L	R	P	U	R	D	L	L	P

	INPUT 1, 3, 5, 7				INPUT 2, 4, 6, 8			
	JU2	JU3	JU7	JU15	JU5	JU6	JU8	JU16
TC NARROW	P	P	R	P	P	P	R	P
TC WIDE	P	P	M	P	P	P	M	P
RTD	P	U	L	P	P	U	L	P
mA	P	P	L	F	P	P	L	F
25 mV	P	P	R	P	P	P	R	P
100 mV	P	P	M	P	P	P	M	P
1 VOLT P	P	P	L	P	P	P	L	P
10 VOLT	P	D	L	P	P	D	L	P

CODE: D - DOWN, L - LEFT, M - MIDDLE, P - PARKED, R - RIGHT, U - UP, F - FITTED

**FIGURE 11-1**

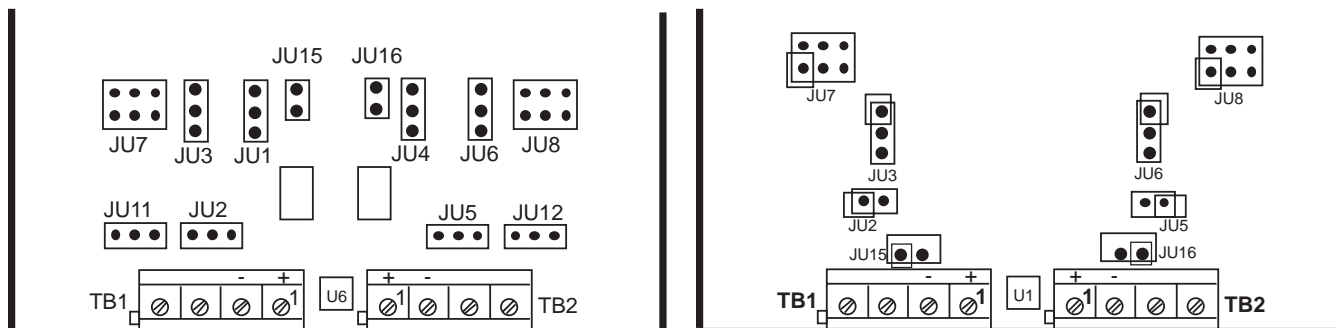



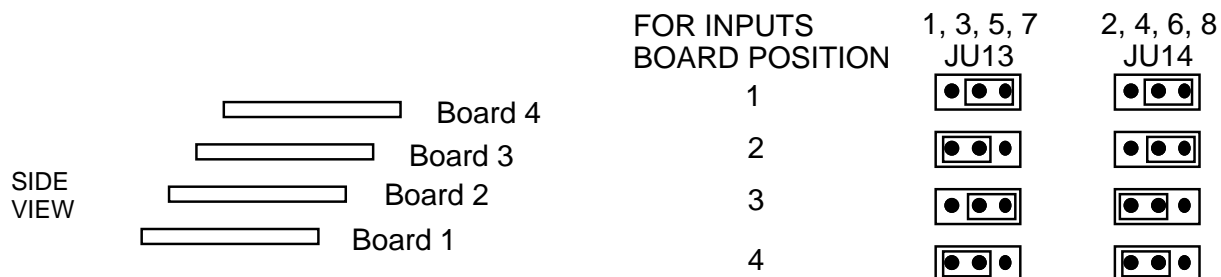

There are up to an additional 2 jumpers per Input Board that are used for BOARD ID. Location (Board 1 is the bottom board) determines the position of JU13 and/or JU14.



When installing an Input Board for any reason, check the location (where this board is mounted), then verify the position of JU13 and/or JU14. **TC WIDE or TC NARROW were selected, go to Step 5, if not, go to Step 6.**

Step 5

Depress the  and the upper display line will show **IVx CAL CJC OR TC** and the lower display line will show **TC, or CJC**. Select TC by depressing the  then the  until TC is blinking, then depress the .

Step 6

Depress the  and the upper display line will show **IVx PERFORM CAL** and the lower display line will show **NO**. Select YES to perform the calibration. Connect the appropriate one of the following inputs to the input terminals of the input being calibrated:

- |                  |                    |
|------------------|--------------------|
| 100 ohm resistor | RTD Inputs         |
| 0.0 mA DC        | Current Inputs     |
| 0.0 mV DC        | TC or mV DC Inputs |
| 0.0 V DC         | Volt Inputs        |

Wait one minute, then depress the  key.

Step 7

Connect the appropriate one of the following inputs to the input terminals of the input being calibrated:

- |                  |                          |
|------------------|--------------------------|
| 277 ohm resistor | RTD Inputs               |
| 20.00 mA DC      | Current Inputs           |
| 25.00 mV DC      | TC or 0/25 mV DC Inputs  |
| 100.00 mV DC     | TC or 0/25+ mV DC Inputs |
| 1.00 V DC        | 1 V DC Inputs            |
| 10.00 V DC       | 10 V DC Inputs           |



Wait one minute, then depress the  key.

Step 8

Repeat steps 1 through 8 for each input to be calibrated.

## 11.2 COLD JUNCTION CALIBRATION

Step 1



With **INPUT CALIBRATION** on the lower display line, press the  to enter the Input Calibration. The upper display will display **CALIBRATE INPUT** and the lower display line will display **IV1**. If other than IV1 or IV2 is to be calibrated, depress  and select the input number for which it is desired to calibrate.



Note: There exists only one CJC sensor per input board or for every two input channels.

Step 2

Depress  and the upper display line will display **IVx CAL BOARD TYPE** (x=input number selected) and the lower display line will display **TC/VOLT** or **RTD**. Select **TC/VOLT**.

Step 3

Depress  and **IVx CAL WHAT RANGE** should appear in the upper display line. Depress ,





then   until **TC NARROW TC WIDE** are displayed in the lower display line. Select which type of TC used by depress-  ing to alternately select **TC NARROW** or **TC WIDE** (see Table 11-2, page 11-2),

then depress the  when the TC Range used is blinking.



Step 4

Be sure that the jumpers on the Input Board for the input being calibrated are positioned as shown in Table 11-3, Page 11-3.



Step 5



Depress the  and **IVx CAL CJC OR TC** will appear in the upper display line, and **TC** or **CJC** will appear in the lower display line. Select **CJC** by depressing the , then the  until **CJC** is blinking, then depress the .

Step 6

**IVx CJC TC TYPE** will appear in the upper display line and **J** will appear in the lower display line. Depress the , then UP, DOWN, LEFT and SCROLL as required to select the type of TC being used, then depress the .

### Step 7

Connect the proper TC type up to the input being calibrated. Place the thermometer next to the **HOT** Junction (sensor point) of the TC connected. Depress the  and the upper display line will display **IVx CAL CJC** and lower display line will display **CJC READS: 25.0 C**. Depress the , then use the UP/DOWN to change the display to read what the mercury thermometer is reading, then depress the .

Step 8  Depress the  and the upper display line will display **IVx PERFORM CAL**. Depress the  and select **YES** to perform calibration of the CJC.

Wait one minute, then depress the  key.

### Step 9

Repeat steps 1 through 8 for each input board to be calibrated.

---

## 11.3 PARAMETER DEFAULTS

This routine will invoke all of the default program parameter values. See Appendix C for the listing of default values.

### Step 1

With **PARAMETER DEFAULTS** in the lower display line, depress the  and **SET DEFAULTS** will appear in the upper display line and **NO** in the lower display line.



### Step 2

 Depress then select YES to set the defaults.

---

## 11.4 CHART CALIBRATION

### Step 1

With **CHART CALIBRATION** in the lower display line, depress  to enter the Chart Calibration. The upper display line will display **START CALIBRATION**. To perform the chart calibration, depress  and select YES, then depress the . Press any key to continue.

### Step 2

The upper display line will display **INNER RING CALIBRATE** and the lower display line will display **SCROLL TOGGLES RING**. The keys will function as follows:

CHART	Will place a dot on the inner or outer ring, whichever is selected for calibration
SCROLL	Will select either the inner or outer ring
UP	Will move the selected (inner or outer) ring position to the left and print a dot in the new position without moving the chart.
DOWN	Will move the selected (inner or outer) ring position to the right and print a dot in the new position without moving the chart.
RESET	Will move the chart 30 steps while not printing any dots
ESC	Will exit with no change to the calibration values
ENTER	Will exit with the new values being stored

Step 3

With **INNER RING CALIBRATE** on the upper display line, depress the  to view the current location of the inner ring zero point. Use UP/DOWN to position the dot accordingly, use RESET to move the chart.

Step 4

Depress  the to toggle the upper display line to read **OUTER RING CALIBRATE**.

---

Step 5

Depress  the to view the current location of the outer ring zero point. Use UP/DOWN to position the dot accordingly, use RESET to move the chart.





Step 6

Depress  the to save calibration values.

## 11.5 MILLIAMP OUTPUT CALIBRATION

This routine is used to adjust the mA Output(s) for span. A milliamp meter is required to perform this calibration.

Step 1

With **mA OUTPUTS** in the lower display line, depress the  and **CAL WHICH mA OUTPUT** appears in the upper display line and **1** appears in the lower display line. To change, depress the  , then the  to desired output number, then depress  .





### Step 2

Connect the milliamp meter across the corresponding output terminals observing proper polarity, terminal 1 is positive.

### Step 3





Depress  and **INITIATE mA CAL** appears in the upper display line and **NO** appears in the lower display line. Depress  select YES, then depress .

### Step 4

The display should be flashing the message: **USE UP/DN TO ADJUST OUTPUT TO 20 mA ENTER WHEN DONE**. Depress  or  and **HIT UP/DN OR ENTER** appears in the upper display line and

**OUTPUT TO 20 mA** appears in the lower display line.

### Step 5

Use the   as necessary to adjust the output to 20.00 on the milliamp meter. Depress  to enter the new value or  to return to previous value. Depressing either ENTER or ESC exits the calibration.

---

## 11.6 SOLENOID CALIBRATION

CONSULT FACTORY.

This adjustment is made with an oscilloscope and a 10 ohm resistor. It should not have to be readjusted unless the setting has been changed inadvertently.

---

## 11.7 CALIBRATION DEFAULTS



This routine will invoke a set of predetermined calibration values that are intended to emulate a "design center" condition. In other words, the calibration values used would be the values derived for a unit whose critical components would be equal to the nominal values. These default values should be used only:

1. When it is known that the current calibration values are inaccurate and not acceptable and quick action is needed to restore the recorder to some basic level of operation.
2. To initially calibrate a brand new input board (never before calibrated) as a starting point in the calibration process. This is the procedure initially used to test the boards on start-up at the factory.

Step 1

With **CALIBRATION DEFAULTS** in the lower display line, depress the  . **SET CAL DEFAULTS** appears in the upper display line and **NO** appears in the lower display line.

Step 2

Depress  and then select YES, then depress  .

---

## SECTION 13 - CONTROLLERS

When the instrument is specified with the Controller option, in addition to the normal configuring required for the Recorder functions, other parameters such as CONTROLLERS, SETPOINTS, and TUNING PARAMETERS will need to be configured in order for the instrument to operate properly.



Along with the above, additional choices will appear in the selection list for certain prompts found elsewhere in this manual.

The main part of the control capability is provided by the controller “functional block”. The controller “functional block” is configured in the CONTROLLERS section of CONFIGURATION. The functional block provides the following capabilities:

- 1) dual output ON/OFF and PID automatic and manual control,
- 2) bumpless and balanceless automatic/manual transfer,
- 3) auto/manual control switching, local/remote switching, and dual setpoint switching,
- 4) setpoint ramping,
- 5) “automatic transfer”,
- 6) slew rate (output ramping), and
- 7) setpoint selecting.

The main (first), second, and remote setpoint sources are selectable. The actuators for auto/manual control switching, local/remote switching, and dual setpoint switching, are selectable.

The following items can be selected for display in the “normal display” mode: the “selected setpoint” (which is the current setpoint value before ramping), the “ramped setpoint” (which is the internal setpoint value, after ramping is applied, which is used as the control point), and the “% outputs”.

Besides the controller block itself, several other items can be configured, SETPOINTS, CONTROL STATE ACCESS, and TUNING. Located in the CONFIGURATION section, SETPOINTS, where setpoints are defined and labeled, and CONTROL STATE ACCESS, used to configure prompting, accessed by the  key, providing easy access to the most often used control activities. TUNING PARAMETERS, included as a section of the SYSTEM PROMPTS, is accessed via the  key from the “normal display”.



Up to 8 setpoints can be configured. Each has a variable text prompt, units, decimal position, limits, and “normal display” display option. Whenever the PROMPT TEXT, as configured in SETPOINTS, is not blank, the setpoint will be displayed in the  key prompts.

The setpoints are not inherently associated with a controller, so they can also be used for ratios, direct drive outs (to a current output), or any other purposes. Setpoint changes can be inhibited via the ENABLES and PASS-WORDS.

The SETPOINTS included in the  prompts are the operator changeable values. The setpoints included in the “normal display” are for display purposes only, and both the currently selected setpoint and the internal ramping setpoint can be displayed.

Control State Access provides an easy and quick way to change controller states (automatic to manual, local setpoint to remote setpoint), via the Display key. When the default control actuator settings are used, they affect the actuators which change the controller states. Note that although the default settings imply a one-to-one correspondence between control state access numbers and controller numbers, this is not necessarily the case. Up to four Control State Accesses may be configured and all four are initially set. If all four are not to be used, the unused should be changed to “blank”.

### EXAMPLE:

Let's consider auto/manual for controller 1 (C1).

The first would be using a remote contact closure input to switch between auto and manual control. This method requires that an input be used for Switch Contact. To configure, set an unused INPUT TYPE/RANGE to SWITCH CONTACT (found in INPUTS part of CONFIGURATION), then set C1 MANUAL ACTUATOR to SWx (x= number of Input Variable set earlier).

A second and possibly more convenient method of changing states would be the “CONTROL STATE ACCESS” programming capability. The CONTROL STATE ACCESS capability is configured in CONFIGURATION and used via the  key. To configure:

Set C1 MANUAL ACTUATOR, found in CONTROLLERS, to CA1F1. Next, set CA1 LINE 1 TEXT, found in CONTROL STATE ACCESS, to CONTROLLER 1 (DEFAULT), CA1 LINE 2 TEXT to A/M (DEFAULT) and CA1 F1 KEY USAGE to C1 AUTO/MANUAL (DEFAULT). NOTE: If only one control is being utilized, it is suggested that the remaining prompts be blank, otherwise they will be displayed.

To utilize the CONTROL STATE ACCESS capability and select either AUTOMATIC or MANUAL control, proceed as follows:

From the "Normal Display", depress the  key, CONTROLLER 1 should be displayed on the upper display line (or what was configured for CA1 LINE 1 TEXT above) and A/M should be displayed on the lower display line (or what was configured for CA1 LINE 2 TEXT above). Depress the key directly below A/M and the lower display line should display AUTOMATIC MANUAL with the active selection blinking. To select Manual, depress the key directly below the MANUAL in the display.

---

### 13.1 ENTERING CONTROLLERS





From the Normal Display, press the  key until CONFIGURATION is seen in the lower display line. If PASSWORD appears in the lower display line, the correct "password" will need to be entered before access to CONFIGURATION is allowed. If CONFIGURATION is not displayed, then Configuration has been disabled. Refer to Section 9, Enables and Passwords, for instructions to enable Configuration.

Note: A Controller, although configured, will not operate unless the corresponding PROCESS VARIABLE (PV) is properly configured.

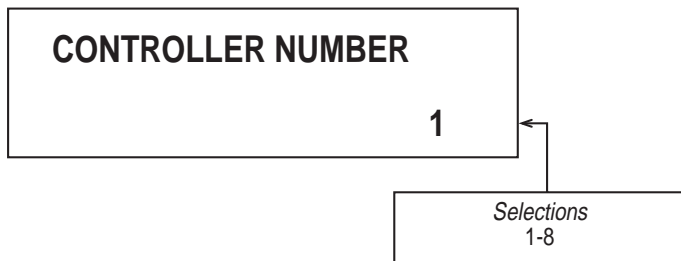
With CONFIGURATION in the lower display line, press the  key, then the  key until CONTROLLERS appears in the lower display line.





1. Press the  key to display CONTROLLER NUMBER.

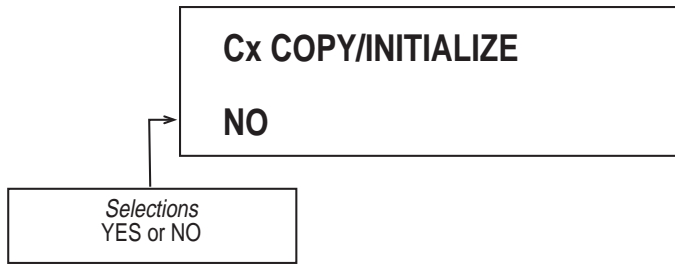

Press  to change, then  or  to desired controller number, then press the  to store into memory.

2. Press the  to advance to the next parameter, COPY/INITIALIZE.





Press the  to change, then  or  to desired selection, then press .

If selection is NO, see Step 3.

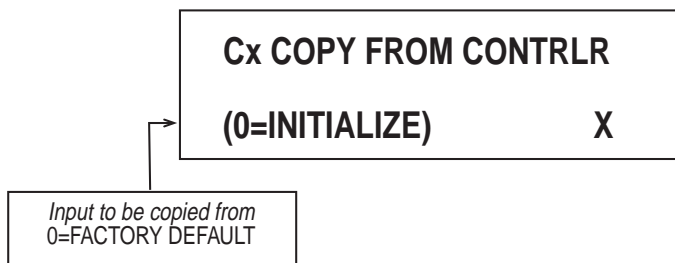



If selection is YES:

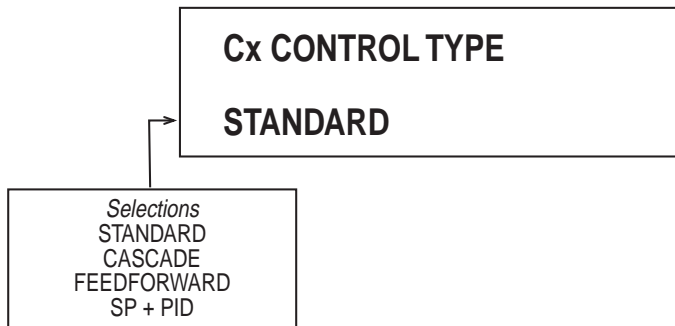

Press the  or  to change to the control number to be copied from.

3. Press the  to advance to the next parameter, CONTROL TYPE.



Press the  to change, then  or  to desired choice, then press the .

CASCADE control uses two “control blocks”. The output of one controller is the setpoint of a second controller. Ratio and bias (see Steps 20 & 21) need to be applied to the connecting setpoint. Because of the interaction between controllers, cascade control will only apply to controllers 1 and 2, or 3 and 4, used in pairs, with 1 and 3 being the first controller.

FEEDFORWARD adds a 0-100% value to the PID output. When feedforward is used, the feedforward source (Step 22) is scaled to provide a 0-100% value to work with the loop output of 0-100%. Depending on the limits of the input, and the scaling, the FF-term may be limited to less than 100%.

SP + PID adds a term that makes the output primarily proportional to the setpoint, but with PID capability added. This is used primarily for flow control.

4. Press the  to advance to the next parameter, OUTPUT 1 TYPE.

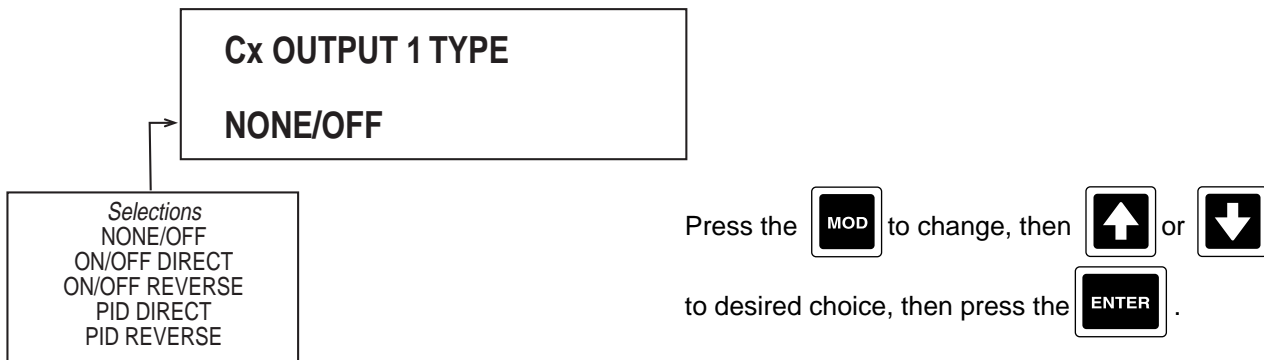

5. Press the  to advance to the next parameter, OUTPUT 2 TYPE.

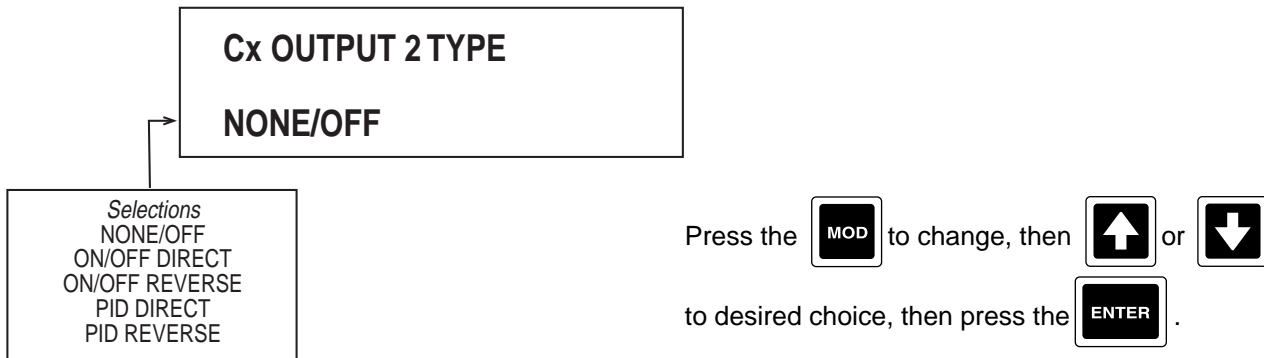

6. Press the  to advance to the next parameter, OUTPUT 1 HYSTERESIS (only seen if OUT 1 TYPE is ON/OFF).

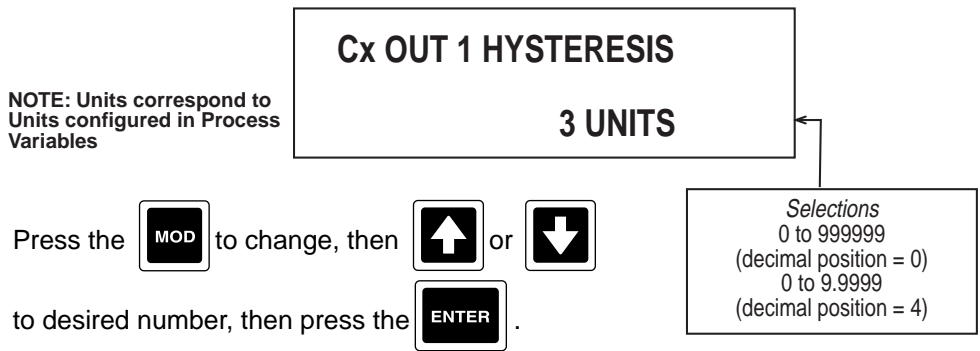

Note: Hysteresis centers on the control setpoint.

7. Press the  to advance to the next parameter, OUTPUT 2 HYSTERESIS (only seen if OUT 2 TYPE is ON/OFF).

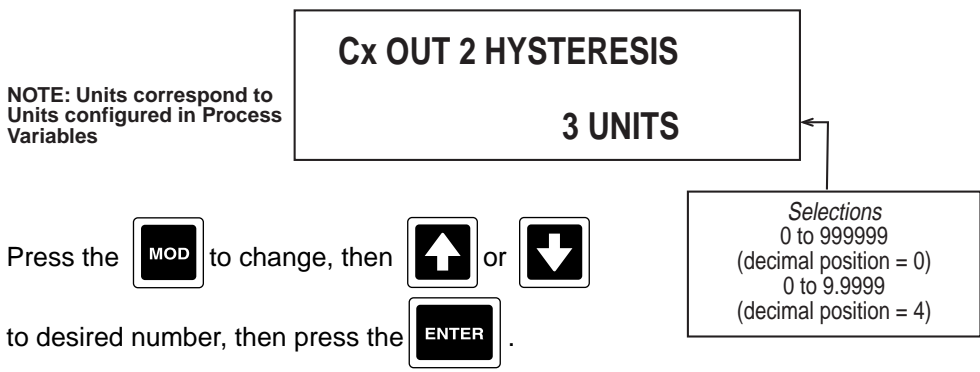



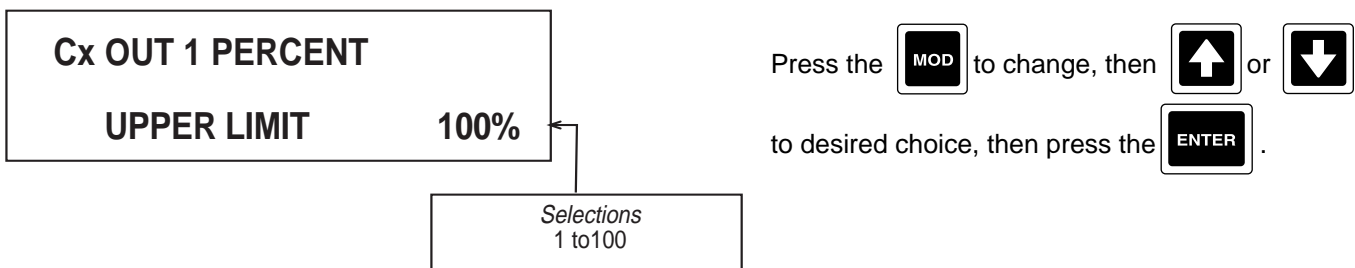

Note: Hysteresis centers on the control setpoint.

8. Press the  to advance to the next parameter, OUTPUT 1 PERCENT UPPER LIMIT (only seen if OUT 1 TYPE is PID).

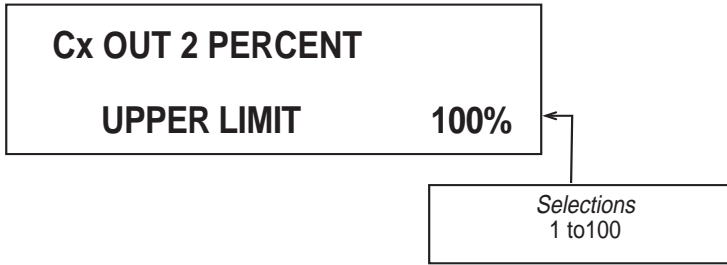





9. Press the  to advance to the next parameter, OUTPUT 2 PERCENT UPPER LIMIT (only seen if OUT 2 TYPE is PID).

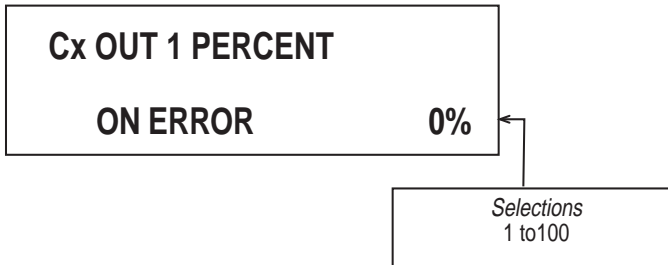

Press the  to change, then  or  to desired choice, then press the .





10. Press the  to advance to the next parameter, OUTPUT 1 PERCENT ON ERROR (only seen if OUT 1 TYPE is PID).

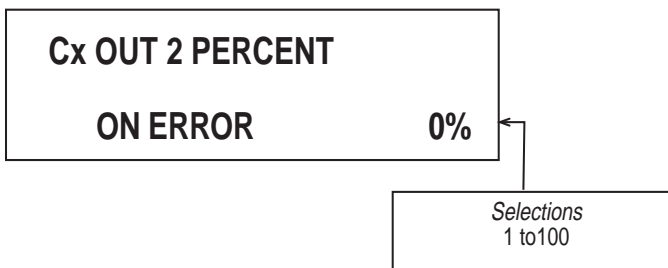

Press the  to change, then  or  to desired choice, then press the .

11. Press the  to advance to the next parameter, OUTPUT 2 PERCENT ON ERROR (only seen if OUT 2 TYPE is PID).







Press the  to change, then  or  to desired choice, then press the .

12. Press the  to advance to the next parameter, OUTPUT SLEW RATE (only available with PID).

**Cx OUTPUT SLEW RATE**  
**0% / MIN**

*Selections*  
0 to 100%  
0 = OFF

Press the  to change, then  or  to desired choice, then press the .

SLEW RATE allows the control to slowly ramp the output to avoid a rapid start up. Abrupt changes may set the outputs to 0%. If the slew rate is programmed to 60%/MIN, the rate of change would be 1%/second.

13. Press the  to advance to the next parameter, MANUAL ACTUATOR (only if either output is proportional)

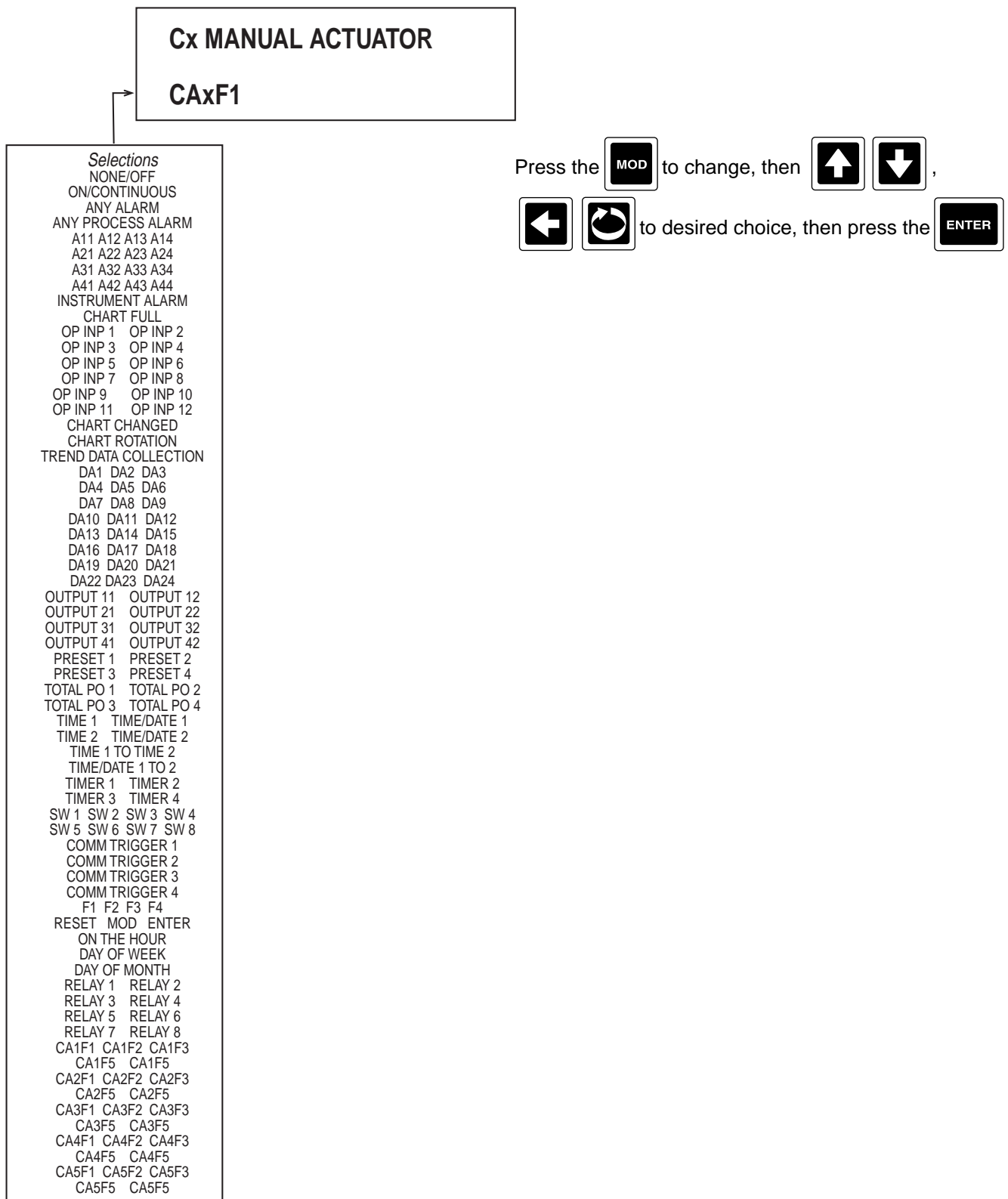





Cx Manual Actuator selects the actuator, when true, switches the instrument to the MANUAL mode of control, and when false, switches back to AUTO mode.

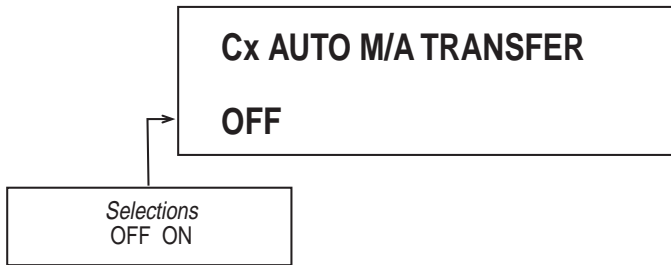

14. Press the  to advance to the next parameter, AUTO MANUAL AUTO TRANSFER (only if MANUAL ACTUATOR is not NONE/OFF).



NOTE: If the process variable reaches setpoint while in manual mode, this parameter, when selected, allows the controller to revert to automatic mode without operator intervention.





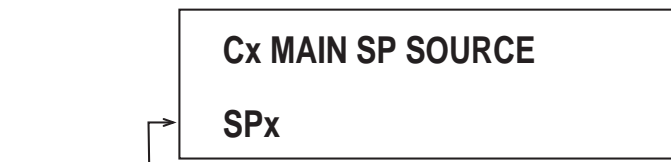

Press the  to change, then  or  to desired choice, then press the .

15. Press the  to advance to the next parameter, MAIN SETPOINT SOURCE.



NOTE: Whatever value is selected as the source of the setpoint, the decimal position and the units type follow what was configured in Process Variables.







- Selections
- NONE USED
  - IV1 IV2 IV3 IV4
  - IV5 IV6 IV7 IV8
  - PV1 PV2 PV3 PV4
  - DV1 DV2 DV3
  - DV4 DV5 DV6
  - DV7 DV8 DV9
  - DV10 DV11 DV12
  - CV1 CV2 CV3 CV4
  - CV5 CV6 CV7 CV8
  - CV9 CV10 CV11 CV12
  - TOTAL 1 TOTAL 2
  - TOTAL 3 TOTAL 4
  - SP1 SP2 SP3 SP4
  - SP5 SP6 SP7 SP8
  - OUTPUT 11 OUTPUT 12
  - OUTPUT 21 OUTPUT 22
  - OUTPUT 31 OUTPUT 32
  - OUTPUT 41 OUTPUT 42
  - SV1 SV2 SV3 SV4

Press the  to change, then  ,   to desired choice, then press the .

16. Press the  to advance to the next parameter, REMOTE SETPOINT ACTUATOR.

**Cx REMOTE SP ACTUATR**  
**CAx5**

- Selections*  
 NONE/OFF  
 ON/CONTINUOUS  
 ANY ALARM  
 ANY PROCESS ALARM  
 A11 A12 A13 A14  
 A21 A22 A23 A24  
 A31 A32 A33 A34  
 A41 A42 A43 A44  
 INSTRUMENT ALARM  
 CHART FULL  
 OP INP 1 OP INP 2  
 OP INP 3 OP INP 4  
 OP INP 5 OP INP 6  
 OP INP 7 OP INP 8  
 OP INP 9 OP INP 10  
 OP INP 11 OP INP 12  
 CHART CHANGED  
 CHART ROTATION  
 TREND DATA COLLECTION  
 DA1 DA2 DA3  
 DA4 DA5 DA6  
 DA7 DA8 DA9  
 DA10 DA11 DA12  
 DA13 DA14 DA15  
 DA16 DA17 DA18  
 DA19 DA20 DA21  
 DA22 DA23 DA24  
 OUTPUT 11 OUTPUT 12  
 OUTPUT 21 OUTPUT 22  
 OUTPUT 31 OUTPUT 32  
 OUTPUT 41 OUTPUT 42  
 PRESET 1 PRESET 2  
 PRESET 3 PRESET 4  
 TOTAL PO 1 TOTAL PO 2  
 TOTAL PO 3 TOTAL PO 4  
 TIME 1 TIME/DATE 1  
 TIME 2 TIME/DATE 2  
 TIME 1 TO TIME 2  
 TIME/DATE 1 TO 2  
 TIMER 1 TIMER 2  
 TIMER 3 TIMER 4  
 SW 1 SW 2 SW 3 SW 4  
 SW 5 SW 6 SW 7 SW 8  
 COMM TRIGGER 1  
 COMM TRIGGER 2  
 COMM TRIGGER 3  
 COMM TRIGGER 4  
 F1 F2 F3 F4  
 RESET MOD ENTER  
 ON THE HOUR  
 DAY OF WEEK  
 DAY OF MONTH  
 RELAY 1 RELAY 2  
 RELAY 3 RELAY 4  
 RELAY 5 RELAY 6  
 RELAY 7 RELAY 8  
 CA1F1 CA1F2 CA1F3  
 CA1F5 CA1F5  
 CA2F1 CA2F2 CA2F3  
 CA2F5 CA2F5  
 CA3F1 CA3F2 CA3F3  
 CA3F5 CA3F5  
 CA4F1 CA4F2 CA4F3  
 CA4F5 CA4F5  
 CA5F1 CA5F2 CA5F3  
 CA5F5 CA5F5

Press the  to change, then   ,  
  to desired choice, then press the .







Remote Actuator selects the actuator, when true, switches the instrument to the REMOTE SETPOINT mode of control, and when false, switches back to LOCAL SETPOINT mode.

17. Press the  to advance to the next parameter, REMOTE SETPOINT SOURCE (only if REMOTE SP ACTUATOR is not NONE/OFF).

**Cx REMOTE SP SOURCE**  
**NONE USED**

NOTE: Whatever value is selected as the source of the setpoint, the decimal position and the units type follow what was configured in Process Variables.







- Selections*
- NONE USED
  - IV1 IV2 IV3 IV4
  - IV5 IV6 IV7 IV8
  - PV1 PV2 PV3 PV4
  - DV1 DV2 DV3
  - DV4 DV5 DV6
  - DV7 DV8 DV9
  - DV10 DV11 DV12
  - CV1 CV2 CV3 CV4
  - CV5 CV6 CV7 CV8
  - CV9 CV10 CV11 CV12
  - TOTAL 1 TOTAL 2
  - TOTAL 3 TOTAL 4
  - SP1 SP2 SP3 SP4
  - SP5 SP6 SP7 SP8
  - OUTPUT 11 OUTPUT 12
  - OUTPUT 21 OUTPUT 22
  - OUTPUT 31 OUTPUT 32
  - OUTPUT 41 OUTPUT 42
  - SV1 SV2 SV3 SV4

Press the  to change, then  ,  
  to desired choice, then press the .

18. Press the  to advance to the next parameter, SECOND SETPOINT ACTUATOR.

**Cx SECOND SP ACTUATR**  
**CAxF3**

- Selections*  
 NONE/OFF  
 ON/CONTINUOUS  
 ANY ALARM  
 ANY PROCESS ALARM  
 A11 A12 A13 A14  
 A21 A22 A23 A24  
 A31 A32 A33 A34  
 A41 A42 A43 A44  
 INSTRUMENT ALARM  
 CHART FULL  
 OP INP 1 OP INP 2  
 OP INP 3 OP INP 4  
 OP INP 5 OP INP 6  
 OP INP 7 OP INP 8  
 OP INP 9 OP INP 10  
 OP INP 11 OP INP 12  
 CHART CHANGED  
 CHART ROTATION  
 TREND DATA COLLECTION  
 DA1 DA2 DA3  
 DA4 DA5 DA6  
 DA7 DA8 DA9  
 DA10 DA11 DA12  
 DA13 DA14 DA15  
 DA16 DA17 DA18  
 DA19 DA20 DA21  
 DA22 DA23 DA24  
 OUTPUT 11 OUTPUT 12  
 OUTPUT 21 OUTPUT 22  
 OUTPUT 31 OUTPUT 32  
 OUTPUT 41 OUTPUT 42  
 PRESET 1 PRESET 2  
 PRESET 3 PRESET 4  
 TOTAL PO 1 TOTAL PO 2  
 TOTAL PO 3 TOTAL PO 4  
 TIME 1 TIME/DATE 1  
 TIME 2 TIME/DATE 2  
 TIME 1 TO TIME 2  
 TIME/DATE 1 TO 2  
 TIMER 1 TIMER 2  
 TIMER 3 TIMER 4  
 SW 1 SW 2 SW 3 SW 4  
 SW 5 SW 6 SW 7 SW 8  
 COMM TRIGGER 1  
 COMM TRIGGER 2  
 COMM TRIGGER 3  
 COMM TRIGGER 4  
 F1 F2 F3 F4  
 RESET MOD ENTER  
 ON THE HOUR  
 DAY OF WEEK  
 DAY OF MONTH  
 RELAY 1 RELAY 2  
 RELAY 3 RELAY 4  
 RELAY 5 RELAY 6  
 RELAY 7 RELAY 8  
 CA1F1 CA1F2 CA1F3  
 CA1F5 CA1F5  
 CA2F1 CA2F2 CA2F3  
 CA2F5 CA2F5  
 CA3F1 CA3F2 CA3F3  
 CA3F5 CA3F5  
 CA4F1 CA4F2 CA4F3  
 CA4F5 CA4F5  
 CA5F1 CA5F2 CA5F3  
 CA5F5 CA5F5

Press the  to change, then   ,  
  to desired choice, then press the .

19. Press the  to advance to the next parameter, SECOND SETPOINT SOURCE (only if SECOND SP ACTUATOR is not NONE/OFF).

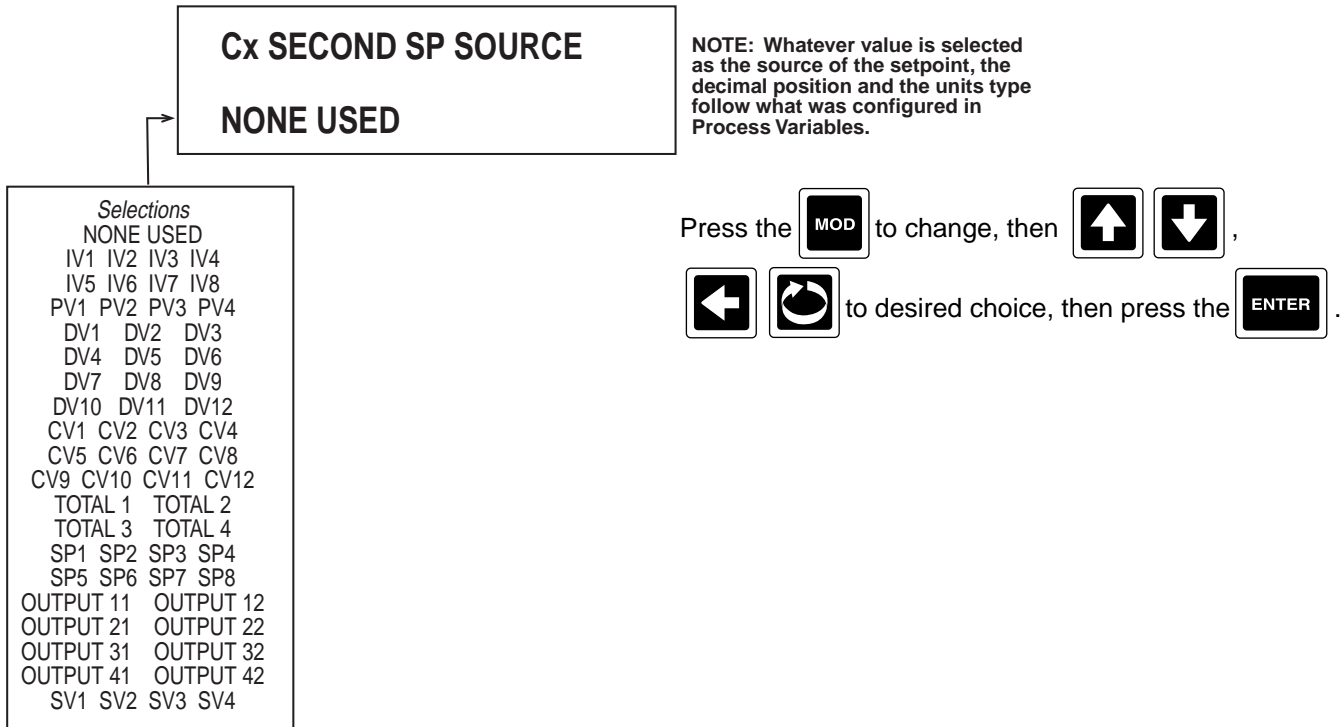

20. Press the  to advance to the next parameter, REMOTE SETPOINT RATIO.

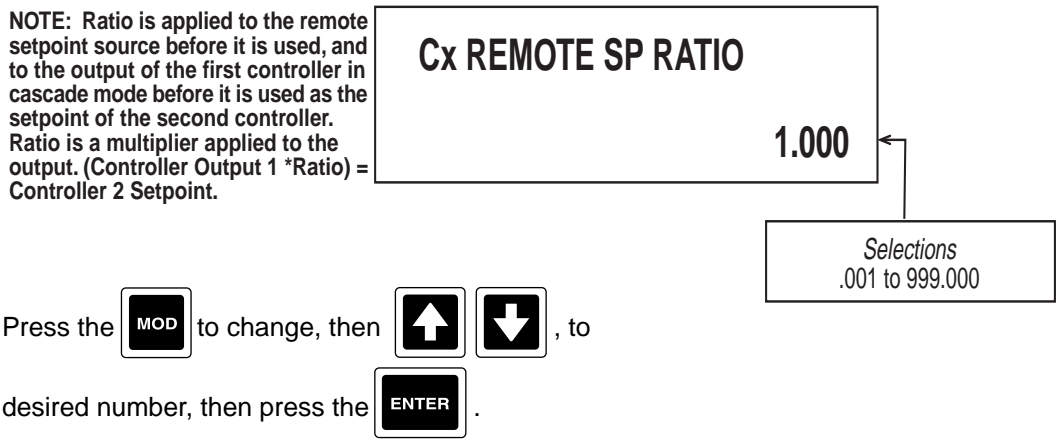





21. Press the  to advance to the next parameter, REMOTE SETPOINT BIAS.

**NOTE:** Bias is applied to the remote setpoint before it is used, and to the output of the first controller in cascade mode, before it is used as the setpoint of the second controller. Bias is an offset added to the output. (Controller Output 1 + Bias) = Controller 2 Setpoint.

**Cx REMOTE SP BIAS**  
0

*Selections*  
± 999999  
(decimal position = 0)  
±9.9999  
(decimal position = 4)







Press the  to change, then  , to desired number, then press the .

22. Press the  to advance to the next parameter, FEEDFORWARD SOURCE (only if FEEDFORWARD was selected as CONTROL TYPE).

**Cx FEEDFORWARD SOURCE**  
NONE USED





**NOTE:** Whatever value is selected as the source of the setpoint, the decimal position and the units type follow what was configured in Process Variables.

*Selections*  
NONE USED  
IV1 IV2 IV3 IV4  
IV5 IV6 IV7 IV8  
PV1 PV2 PV3 PV4  
DV1 DV2 DV3  
DV4 DV5 DV6  
DV7 DV8 DV9  
DV10 DV11 DV12  
CV1 CV2 CV3 CV4  
CV5 CV6 CV7 CV8  
CV9 CV10 CV11 CV12  
TOTAL 1 TOTAL 2  
TOTAL 3 TOTAL 4  
SP1 SP2 SP3 SP4  
SP5 SP6 SP7 SP8  
OUTPUT 11 OUTPUT 12  
OUTPUT 21 OUTPUT 22  
OUTPUT 31 OUTPUT 32  
OUTPUT 41 OUTPUT 42  
SV1 SV2 SV3 SV4

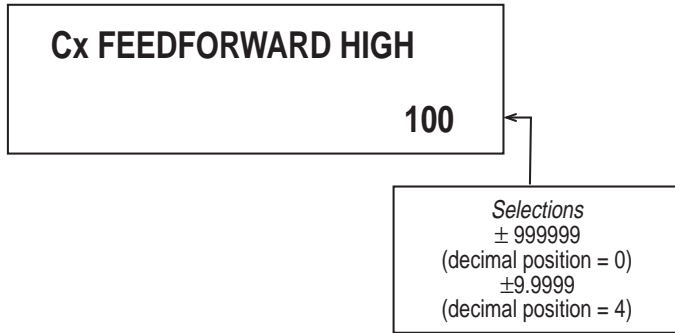
Press the  to change, then  ,  , to desired choice, then press the .





23. Press the  to advance to the next parameter, FEEDFORWARD HIGH (only if FEEDFORWARD was selected as CONTROL TYPE).

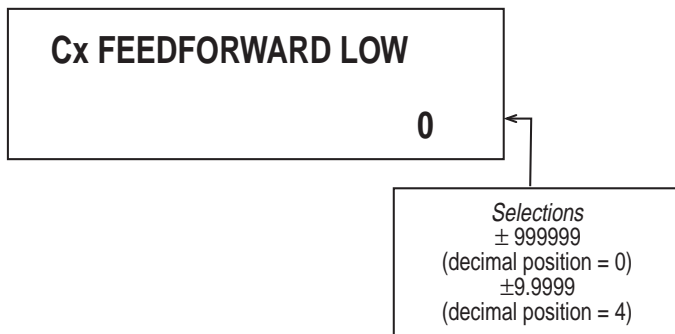

Press the  to change, then   , to desired number, then press the  .





24. Press the  to advance to the next parameter, FEEDFORWARD LOW (only if FEEDFORWARD was selected as CONTROL TYPE).

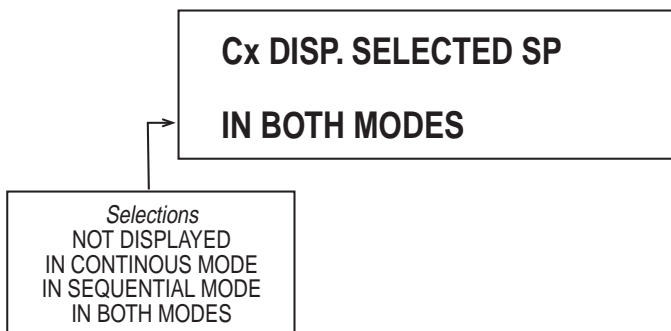

Press the  to change, then   , to desired number, then press the  .





25. Press the  to advance to the next parameter, DISPLAY SELECTED SETPOINT.

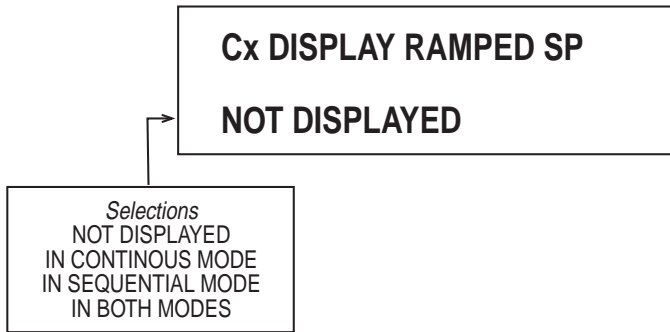

Press the  to change, then   , to desired choice, then press the  .





26. Press the  to advance to the next parameter, DISPLAY RAMPED SETPOINT.

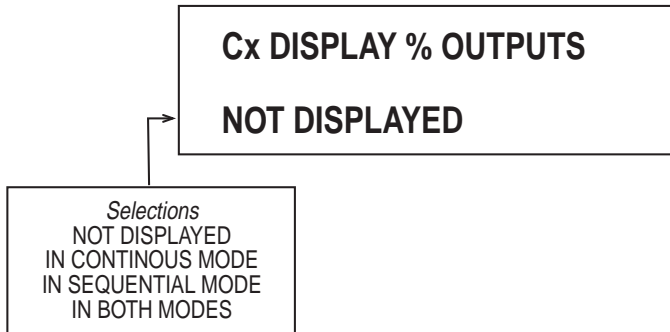

Press the  to change, then  , to desired choice, then press the .

27. Press the  to advance to the next parameter, DISPLAY % OUTPUTS (only if either output is proportional).



Press the  to change, then  , to desired choice, then press the .

28. Press the  and the display advances to the next controller to be programmed. Refer to the beginning of this section, page 13-3.





---



## 13.2 CONTROL SETPOINTS

There are 8 Control Setpoints that can be configured in the SETPOINTS section of CONFIGURATION. This menu sets the text prompt for the setpoint, the unit type, decimal position, limits and the display option mode.

Setting and/or changing the setpoints is accomplished via the  prompt section.

If the PROMPT TEXT description for the setpoint is blank, the setpoint IS NOT ACTIVE and WILL NOT BE DISPLAYED in the  prompt section.

From the Normal Display, press the  key until CONFIGURATION is seen in the lower display line. If PASSWORD appears in the lower display line, the correct "password" will need to be entered before access to CONFIGURATION is allowed. If CONFIGURATION is not displayed, then Configuration has been disabled. Refer to Section 9, Enables and Passwords, for instructions to enable Configuration.

With CONFIGURATION in the lower display line, press the  key, then the  key until SETPOINTS appears in the lower display line.

1. Press the  key to display SETPOINT NUMBER.

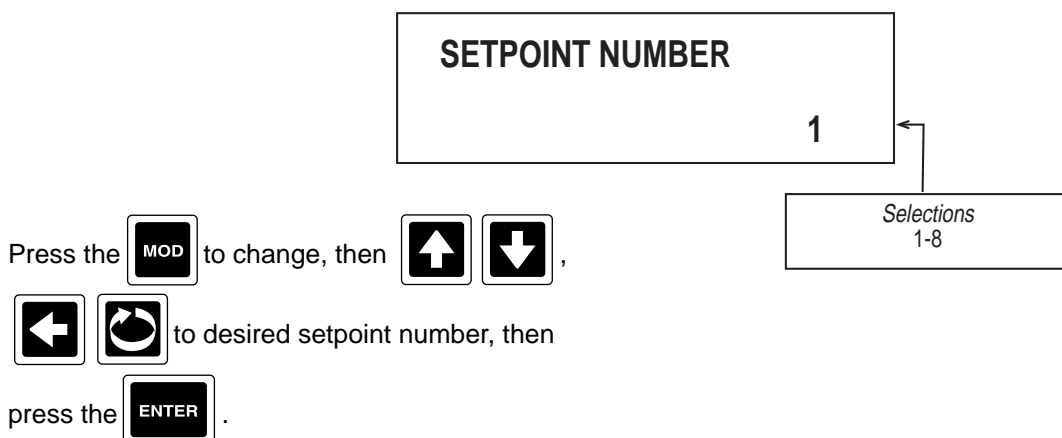

2. Press the  to advance to the next parameter, PROMPT TEXT.

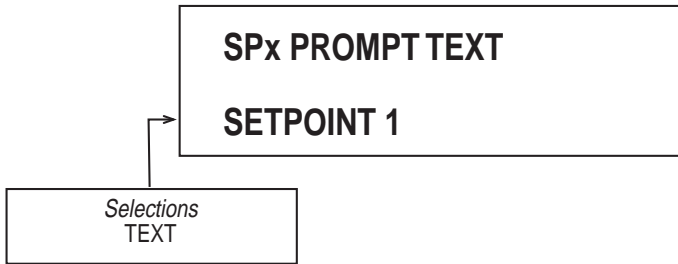



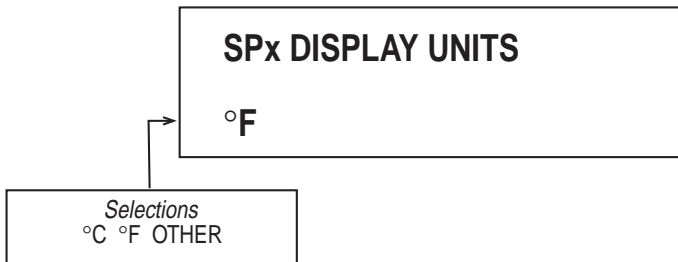

Refer to Section 3.4.2, Changing Text, for instructions.

Note: If PROMPT TEXT is blank, the corresponding setpoint will not be activated or appear in the prompts associated with the  key. Also, no other prompts are displayed for configuring the setpoint.

3. Press the  to advance to the next parameter, DISPLAY UNITS.



Press the  to change, then   to desired choice, then press the  , or press the key directly below the desired choice.

4. If DISPLAY UNITS selected was OTHER, press the  to advance to the next parameter, OTHER UNITS.

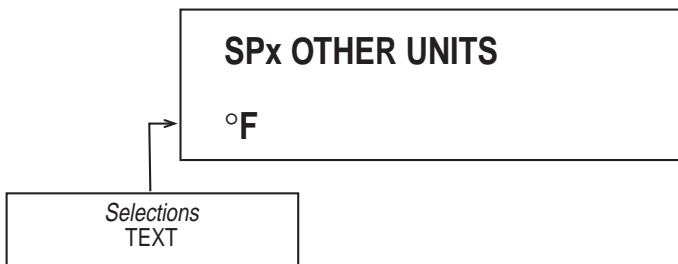

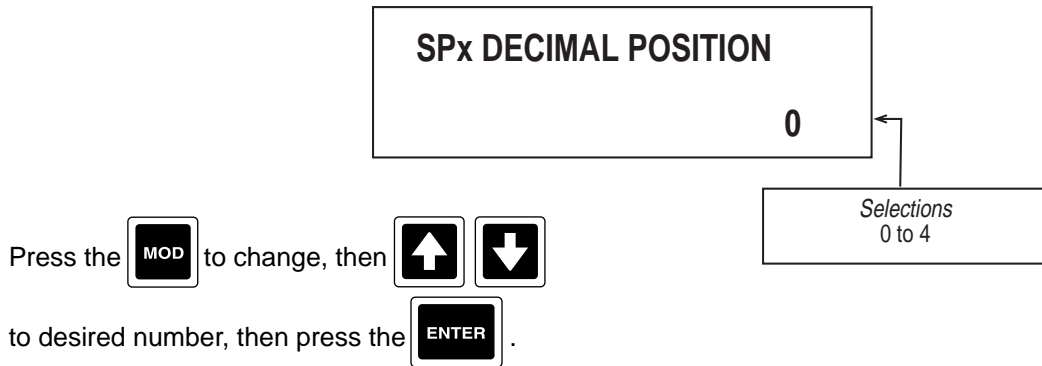

Refer to Section 3.4.2, Changing Text, for instructions.

5. Press the  to advance to the next parameter, DECIMAL POSITION.

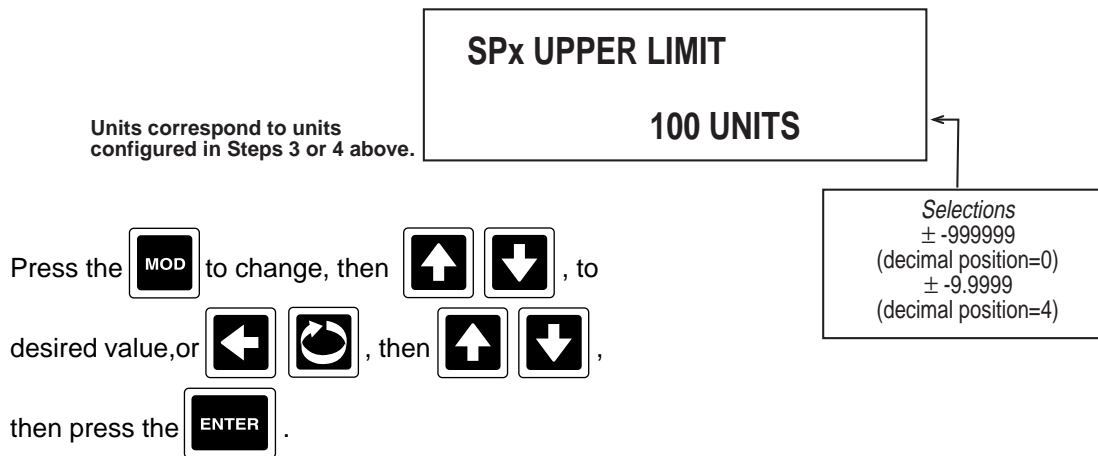

6. Press the  to advance to the next parameter, UPPER LIMIT.



7. Press the  to advance to the next parameter, LOWER LIMIT.

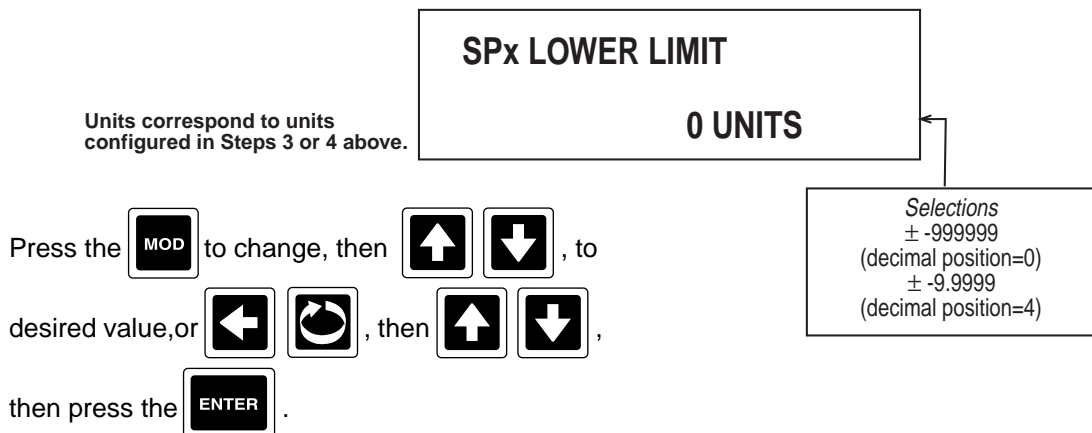

8. Press the  to advance to the next parameter, DISPLAY OPTION.

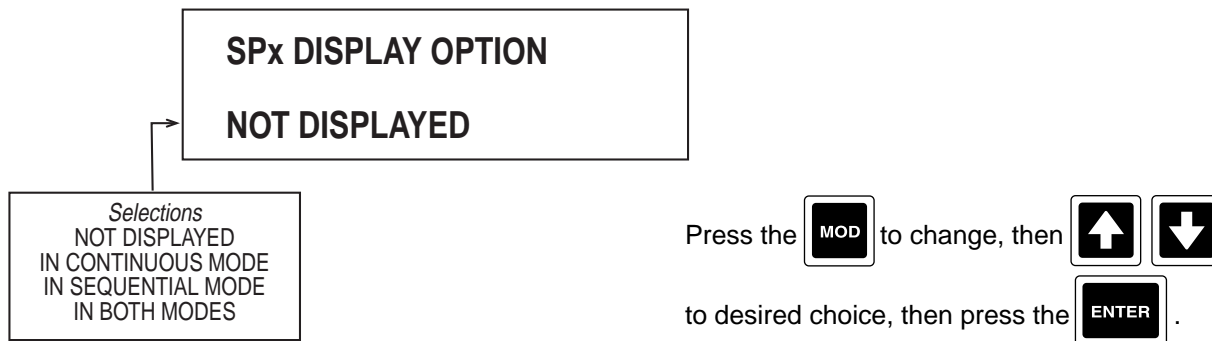





9. Press the  and the display advances to the next setpoint to be programmed. Refer to the beginning of this section, page 13-18.



---

### 13.3 CONTROL STATE ACCESS

CONTROL STATE ACCESS provides a quick and convenient method for changing states, such as AUTO to MANUAL or LOCAL to REMOTE setpoint. If configured, when the  key is pressed, a two line prompt is displayed and the Function Keys, as configured, perform these change state requirements. The two line prompt which appears is fully configurable via the CONTROL STATE ACCESS section of CONFIGURATION.

From the Normal Display, press the  key until CONFIGURATION is seen in the lower display line. If PASSWORD appears in the lower display line, the correct "password" will need to be entered before access to CONFIGURATION is allowed. If CONFIGURATION is not displayed, then Configuration has been disabled. Refer to Section 9, Enables and Passwords, for instructions to enable Configuration.

With CONFIGURATION in the lower display line, press the  key, then the  key until CONTROL STATE ACCESS appears in the lower display line. Press the  key to display CONTROL STATE ACCESS on the upper display line.

1. Press the  and LINE 1 TEXT appears in the upper display line and CONTROLLER x STATES appears in the lower display line. This prompt defines the text that will appear in the upper display line when the  key is pressed while in the Normal Display.

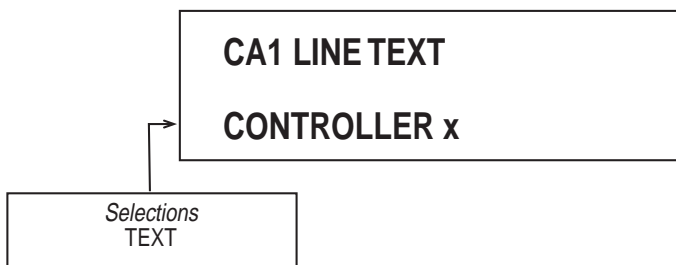

Refer to Section 3.4.2, Changing Text, for instructions .

NOTE: If the CONTROL STATE ACCESS is not being used for Controller 1, it is suggested that this prompt be blank.

2. Press the  to advance to the next parameter, LINE 2 TEXT.

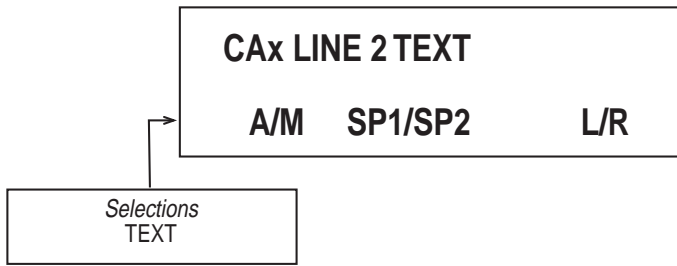



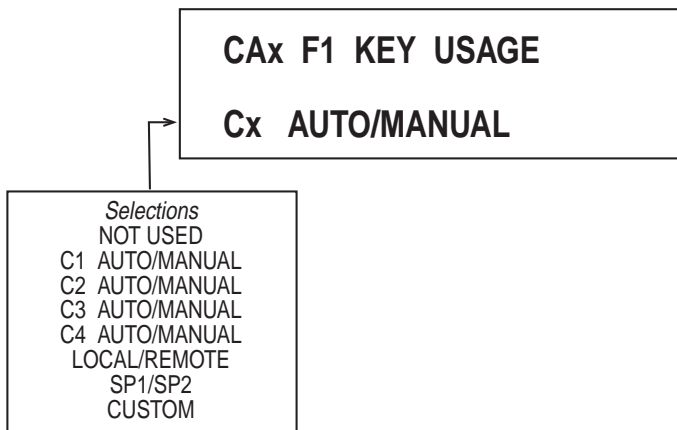

Refer to Section 3.4.2, Changing Text,  
for instructions .

NOTE: If the CONTROL STATE ACCESS is not being used for Controller 1, OR, if SP1/SP2 AND/OR LOCAL REMOTE (L/R), it is suggested that this prompt be blank.

3. Press the  to advance to the next parameter, F1 KEY USAGE.



Press the  to change, then  or   
to desired choice, then press the  .

4. Press the  to advance to the next parameter, F1 LINE 1 TEXT.

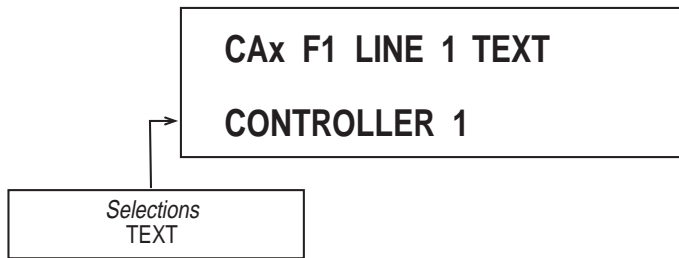

Refer to Section 3.4.2, Changing Text,  
for instructions .

5. Press the  to advance to the next parameter, F1 OFF STATE TEXT (only seen if KEY USAGE selected was CUSTOM).

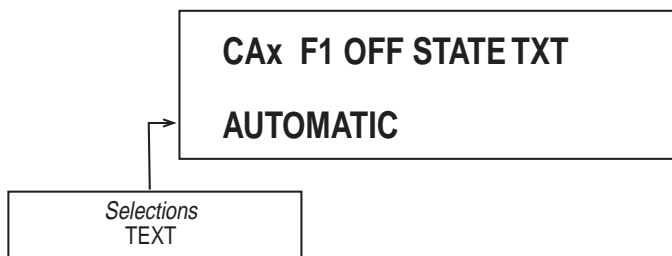

Refer to Section 3.4.2, Changing Text,  
for instructions .



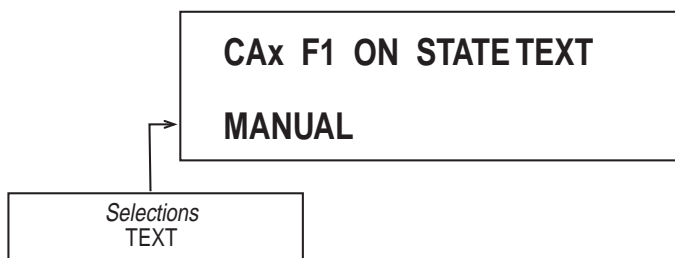

6. Press the  to advance to the next parameter, F1 ON STATE TEXT (only seen if KEY USAGE selected was CUSTOM).

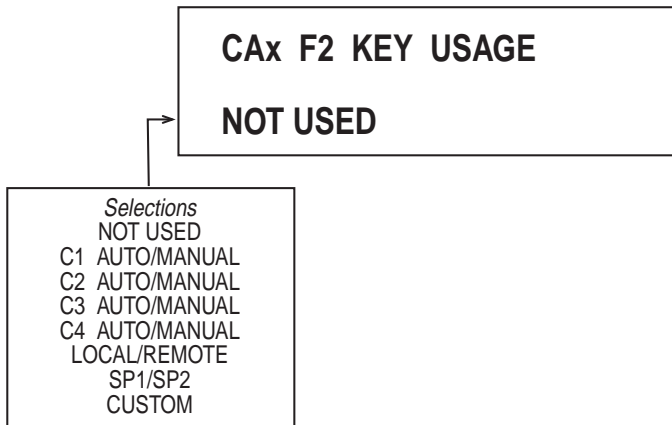

Refer to Section 3.4.2, Changing Text,  
for instructions .

7. Press the  to advance to the next parameter, F2 KEY USAGE.



Press the  to change, then    
to desired choice, then press the .

8. Press the  to advance to the next parameter, F2 LINE 1 TEXT (only seen if F2 KEY USAGE selected is other than NOT USED).

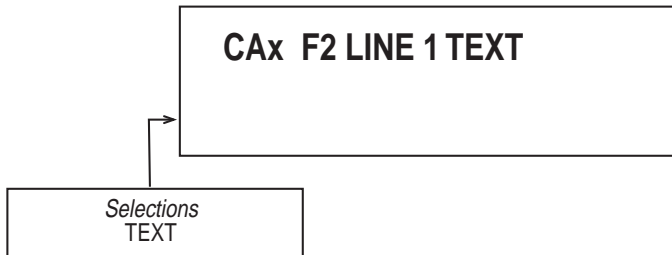

Refer to Section 3.4.2, Changing Text,  
for instructions .

9. Press the  to advance to the next parameter, F2 OFF STATE TEXT (only seen if KEY USAGE selected was CUSTOM).

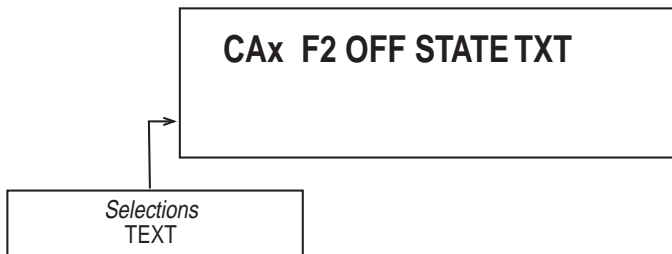

Refer to Section 3.4.2, Changing Text,  
for instructions .





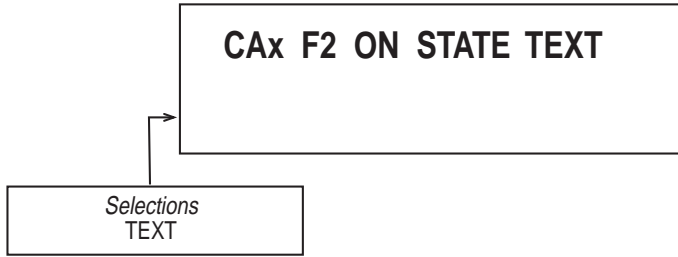

10. Press the  to advance to the next parameter, F2 ON STATE TEXT (only seen if KEY USAGE selected was CUSTOM).

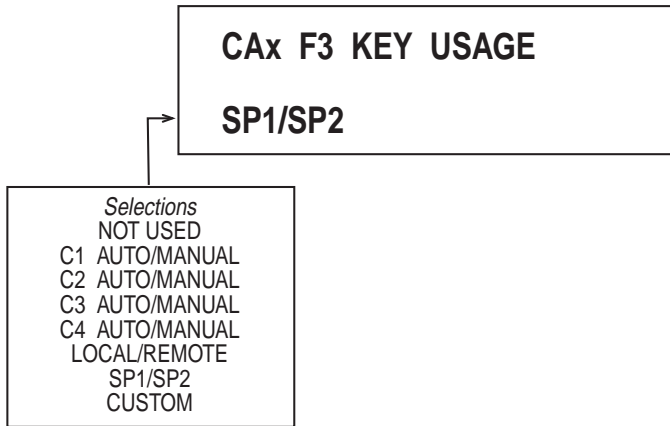

Refer to Section 3.4.2, Changing Text, for instructions .

11. Press the  to advance to the next parameter, F3 KEY USAGE.



Press the  to change, then  or  to desired choice, then press the .

12. Press the  to advance to the next parameter, F3 LINE 1 TEXT.

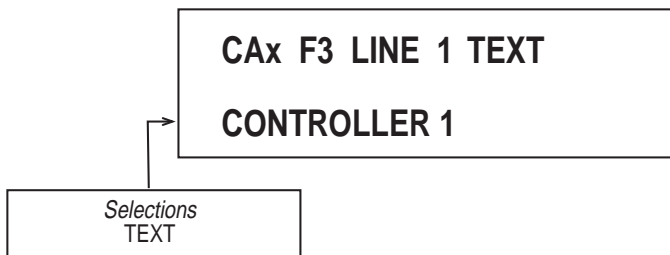

Refer to Section 3.4.2, Changing Text, for instructions .

13. Press the  to advance to the next parameter, F3 OFF STATE TEXT (only seen if KEY USAGE selected was CUSTOM).

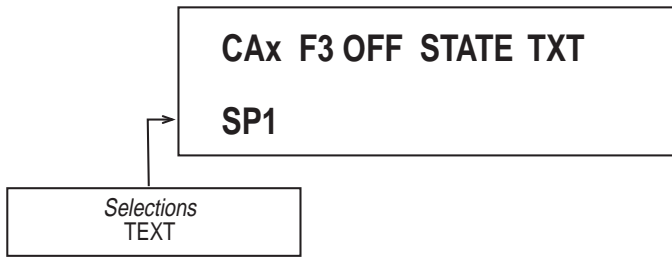

Refer to Section 3.4.2, Changing Text, for instructions .



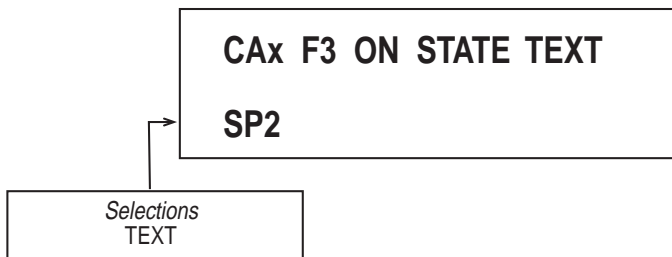

14. Press the  to advance to the next parameter, F3 ON STATE TEXT (only seen if KEY USAGE selected was CUSTOM).

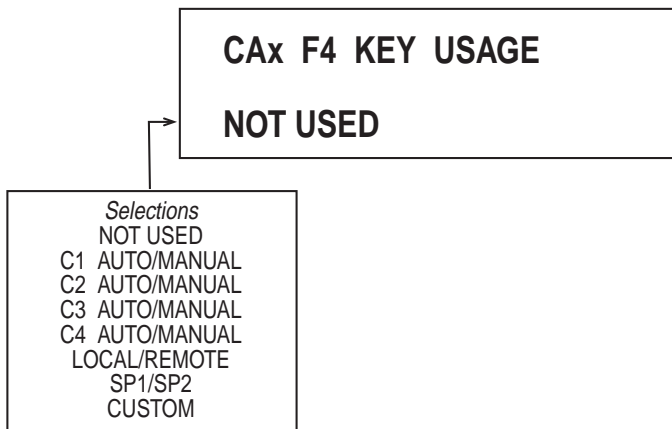

Refer to Section 3.4.2, Changing Text, for instructions .

15. Press the  to advance to the next parameter, F4 KEY USAGE.



Press the  to change, then  or  to desired choice, then press the  .

16. Press the  to advance to the next parameter, F4 LINE 1 TEXT (only seen if F4 KEY USAGE selected is other than NOT USED).

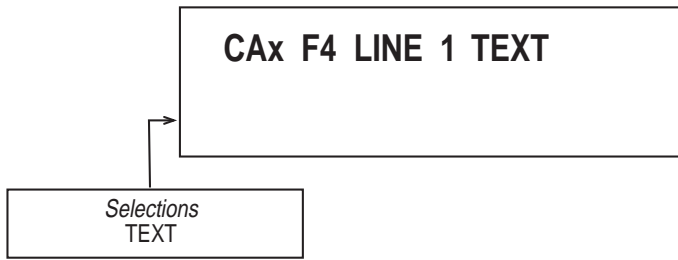

Refer to Section 3.4.2, Changing Text, for instructions .

17. Press the  to advance to the next parameter, F4 OFF STATE TEXT (only seen if KEY USAGE selected was CUSTOM).

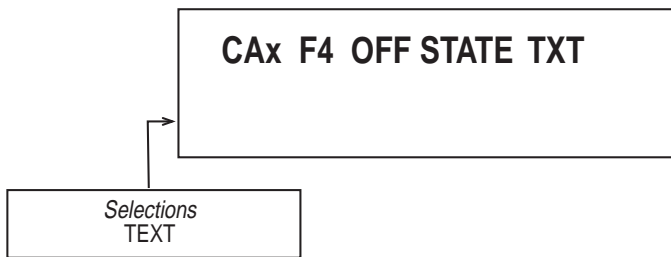

Refer to Section 3.4.2, Changing Text, for instructions .



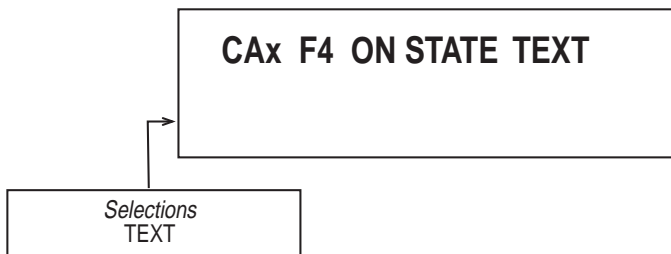

18. Press the  to advance to the next parameter, F4 ON STATE TEXT (only seen if KEY USAGE selected was CUSTOM).

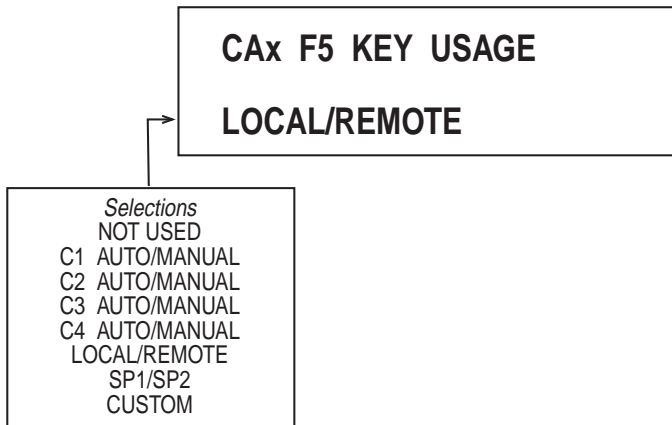

Refer to Section 3.4.2, Changing Text, for instructions .

19. Press the  to advance to the next parameter, F5 KEY USAGE.



Press the  to change, then  or  to desired choice, then press the .

20. Press the  to advance to the next parameter, F5 LINE 1 TEXT.

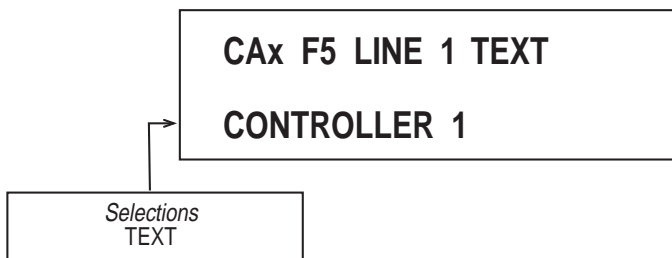

Refer to Section 3.4.2, Changing Text, for instructions .

21. Press the  to advance to the next parameter, F5 OFF STATE TEXT (only seen if KEY USAGE selected was CUSTOM).

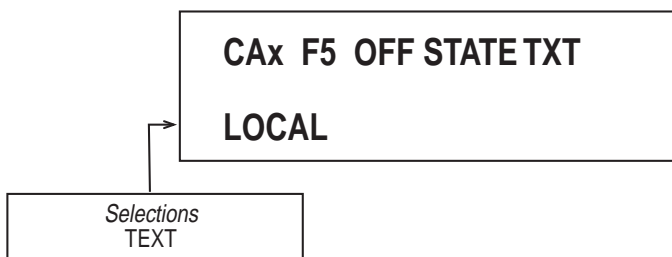

Refer to Section 3.4.2, Changing Text, for instructions .

22. Press the  to advance to the next parameter, F5 ON STATE TEXT (only seen if KEY USAGE selected was CUSTOM).

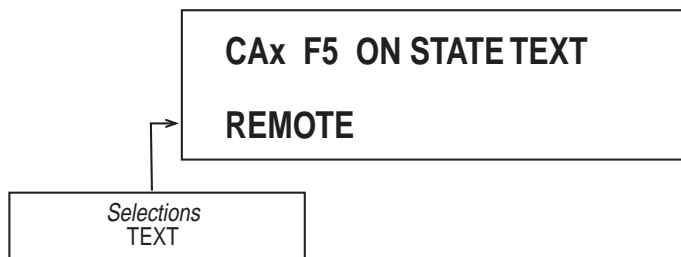

Refer to Section 3.4.2, Changing Text, for instructions .

23. Press the  and the display advances to the next Control State Access to be programmed. Refer to the beginning of this section, page 13-22 .

---

## 13.4 TUNING PARAMETERS

The Tuning parameters section is where adjustments to the proportional band, automatic reset (integral), and other parameters for proper operation of proportional controls and/or first output/second output etc. for on/off controls are made.





For illustration purposes, all available parameters have been listed. The parameters that will appear on the specific instrument will depend upon the parameters previously selected in CONTROLLERS section.

To enter TUNING PARAMETERS, from the Normal Display, press the  key until TUNING PARAMETERS is seen in the lower display line. If PASSWORD appears in the lower display line, the correct "password" will need to be entered before access to TUNING PARAMETERS is allowed. If TUNING PARAMETERS is not displayed, then Tuning Parameters has been disabled. Refer to Section 9, Enables and Passwords, for instructions to enable Tuning Parameters.

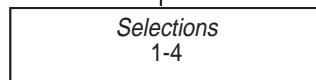
With TUNING PARAMETERS in the lower display line:





1. Press the  key to display CONTROLLER NUMBER.

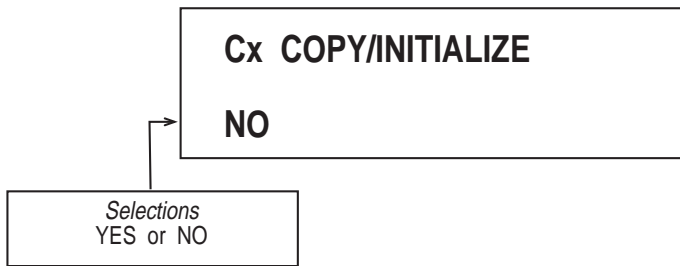

Press the  to change, then  or  to desired controller number, then press the .

2. Press the  to advance to the next parameter, COPY/INITIALIZE.





Press the  to change, then  or  to desired selection, then press the .

If selection is NO, see Step 3.

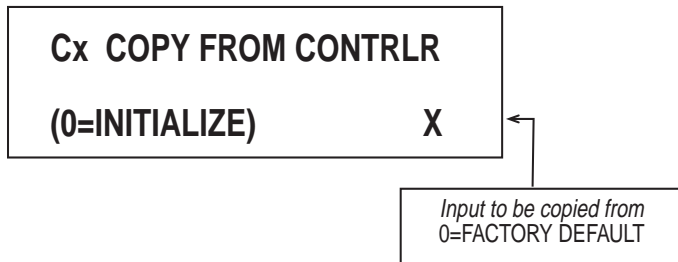



If selection is YES:

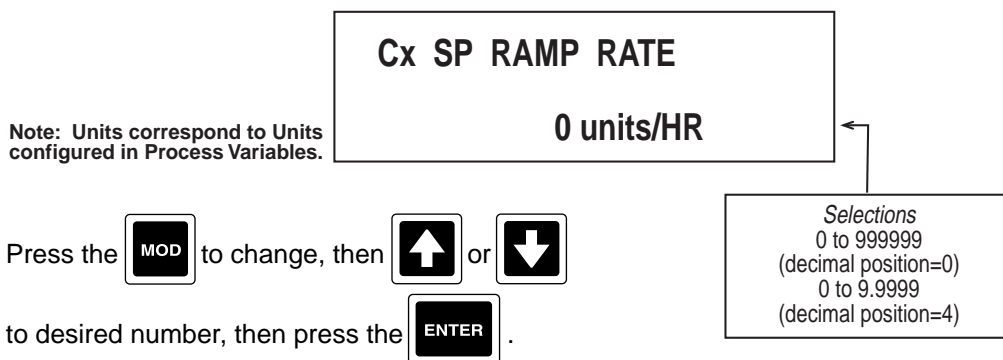

Press the  or  to the control number to be copied from

3. Press the  to advance to the next parameter, SETPOINT RAMP RATE.



Press the  to change, then  or  to desired number, then press the .

RAMP RATE dampens the rate at which the control algorithm will ramp to the control setpoint. If the setpoint changes abruptly from one value to another, an internal setpoint will be ramping to the selected setpoint (SP1, SP2, or Remote) at the rate selected in Cx SP RAMP RATE. The internal setpoint is viewable by setting the ramped setpoint parameter, Cx DISPLAY RAMPED SP located in CONTROLLERS section to something other than NOT DISPLAYED.

4. Press the  to advance to the next parameter, OUTPUT 1 PROPORTIONAL BAND (only if Output 1 Type in CONTROLLERS was set to PID).

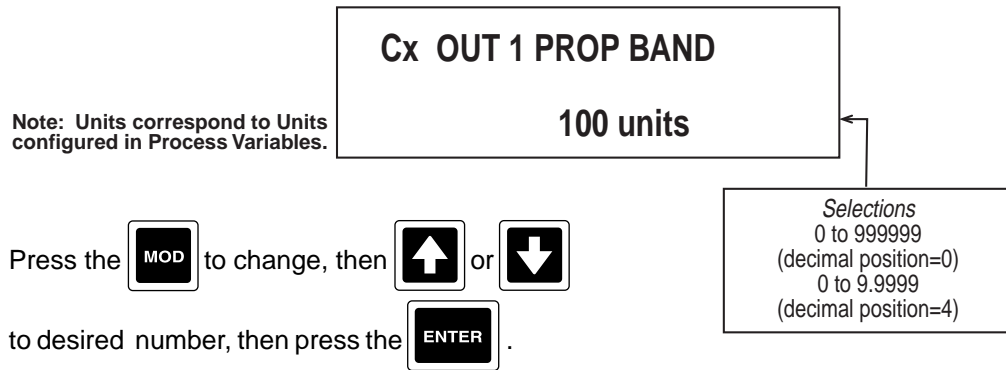

NOTE: When the Process Variable equals the Setpoint the unshifted proportional band provides 0% output.

5. Press the  to advance to the next parameter, OUTPUT 2 PROPORTIONAL BAND (only if Output 2 Type in CONTROLLERS was set to PID).

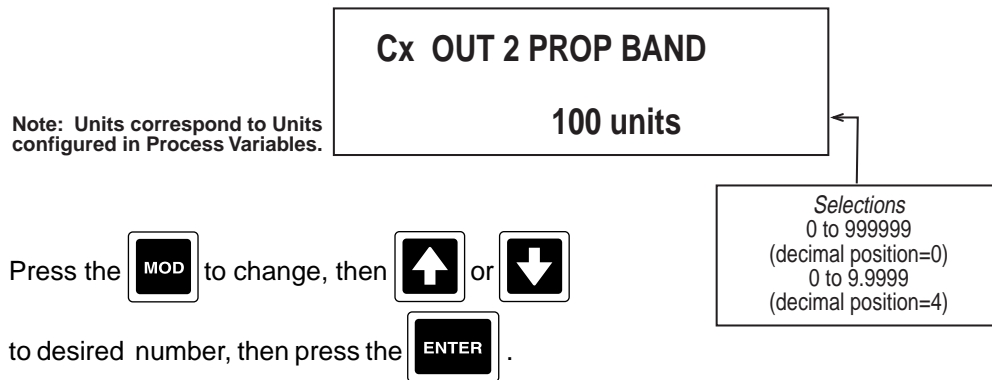



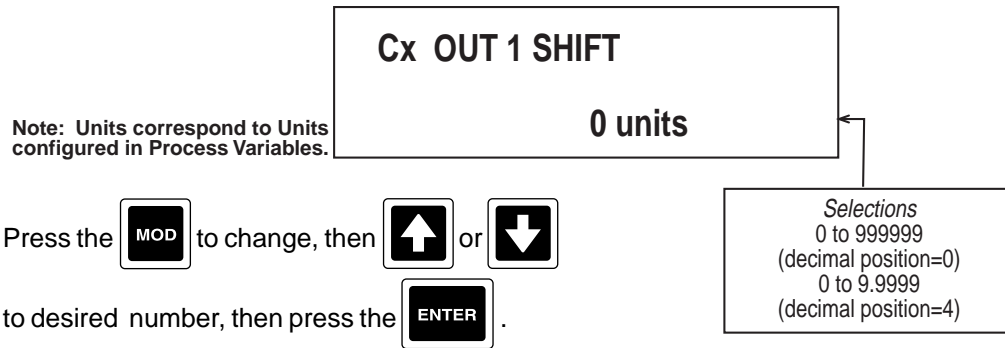

6. Press the  to advance to the next parameter, OUTPUT 1 SHIFT.

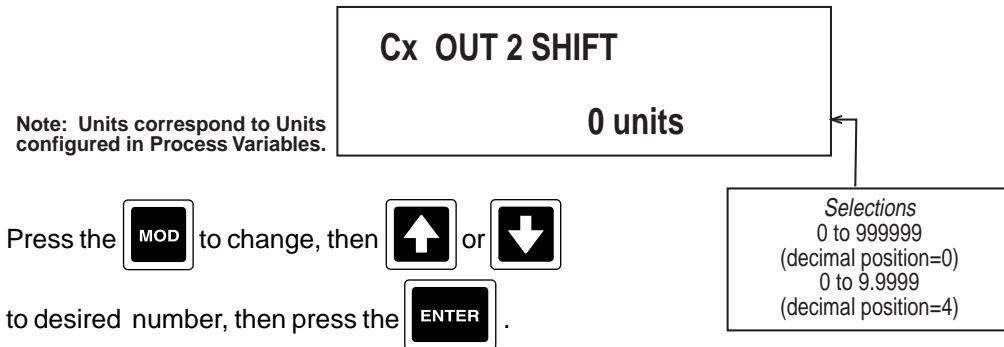

7. Press the  to advance to the next parameter, OUTPUT 2 SHIFT (only if Output 2 is used).



OUTPUT SHIFT represents an offset of the on-off actuation points or proportional band relative to the normal position. For example, if two on-off outputs are being used, one for heating and one for cooling, and a deadband of  $2\infty$  is desired between the two, set OUT 1 SHIFT to -1 and set OUT 2 SHIFT to +1.

8. Press the  to advance to the next parameter, INTEGRATION BAND (only if proportional output).

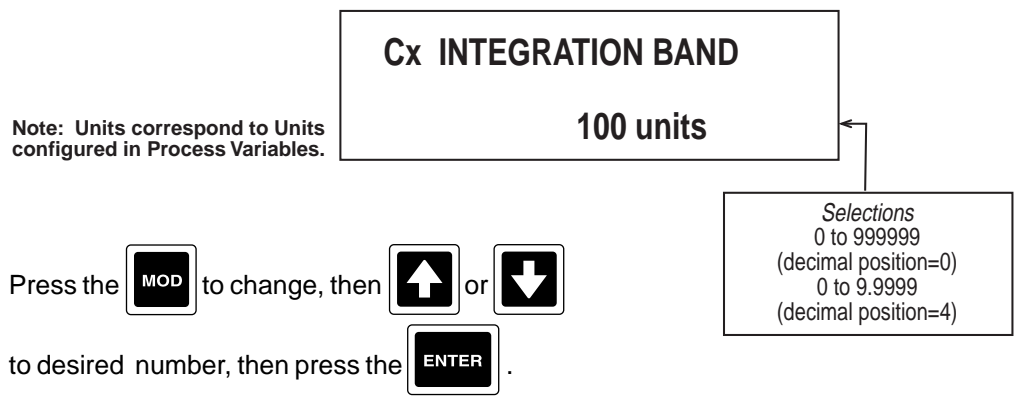

INTEGRATION BAND sets the range where integration of the error will occur, centered on the control setpoint.



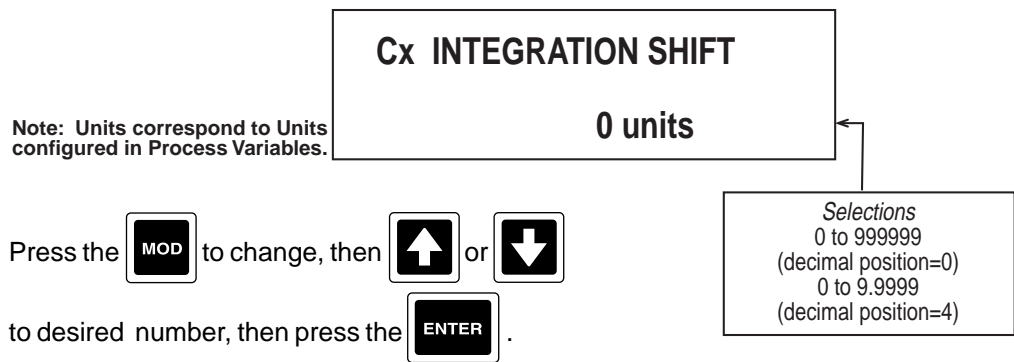

9. Press the  to advance to the next parameter, INTEGRATION SHIFT (only if proportional output).

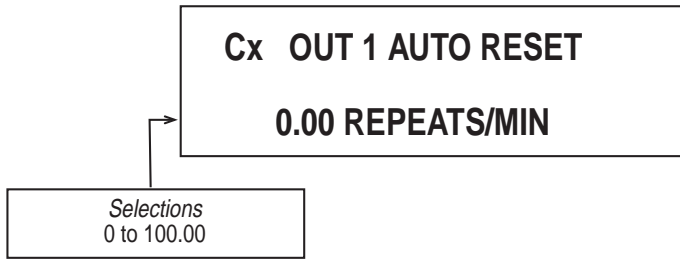

INTEGRATION SHIFT represents a shift or offset for the integration band from its normal operating position, centered on the control setpoint.





10. Press the  to advance to the next parameter, OUTPUT 1 AUTO RESET (only if output 1 is proportional).

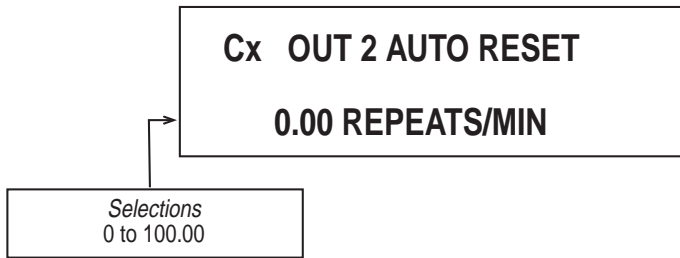

Press the  to change, then  or  to desired number, then press the .

11. Press the  to advance to the next parameter, OUTPUT 2 AUTO RESET (only if output 2 is proportional).





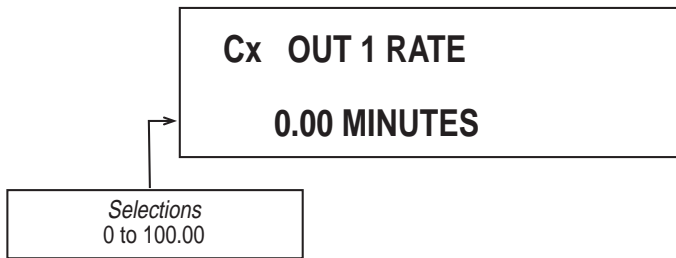

Press the  to change, then  or  to desired number, then press the .

AUTO RESET (Integration) compensates for process load variations which cause the process value to deviate from setpoint. Integration will occur over the range defined by the INTEGRATION BAND. The value is defined in repeats per minute.





12. Press the  to advance to the next parameter, OUTPUT 1 RATE (only if output 1 is proportional).

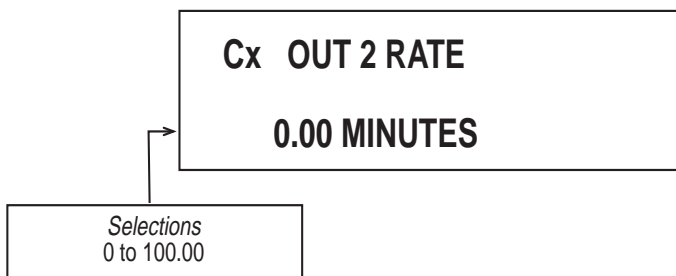

Press the  to change, then  or  to desired number, then press the .

13. Press the  to advance to the next parameter, OUTPUT 2 RATE (only if output 2 is proportional).



Press the  to change, then  or  to desired number, then press the .

RATE attempts to anticipate rapid changes in system response and compensates before overshoot occurs. Rate can be applied at anytime, unlike auto reset which occurs within the integration band. The value is defined in minutes.

14. Press the  and the display advances to the next controller to be tuned. Refer to the beginning of this section, page 13-31 .

---

## SECTION 14 - PROFILERS

The profiling capability basically consists of a functional block that modifies the setpoint(s) and event outputs over time. The setpoint profiling is linked to the first four setpoints and the four process values. Event outputs are merely actuators that can be used for any purpose, but typically drive relay outputs.

The Profile Settings section, included in CONFIGURATION, is used to specify some basic profile configuration data that applies to every profile. The Profile Entry section, accessed via the SCROLL key, is used to enter profile data; ramp and dwell times, setpoints, event outputs, and other associated data. A Profile Control section, accessed via the DISP key, provides the means to initiate/abort a profile, change the run/hold state, and continue an aborted profile.

A profile is made up of one to eight segments, with each segment consisting of a ramp and a dwell. The ramp will change the setpoint value from its current value (or the current process value on the first ramp) to the value specified over a designated time period (ramp time). The dwell maintains that setpoint for a designated time period (dwell time). The event outputs will change state at the beginning of each ramp and dwell as specified. Each setpoint is assumed to be tied to its respective PV (setpoint 1 used with process value 1). Since there are four control loops and four process values, only the first four setpoints can be profiled.

---

### 14.1 PROFILE ENTRY

To enter the Profile Entry section, from the Normal Display, press the SCROLL key until PROFILE ENTRY is seen in the lower display line. If PROFILE ENTRY is not displayed, then it has been disabled. Refer to Section 9, Enables and Passwords, for instructions to enable Profile Entry.

1. With PROFILE ENTRY displayed, depress the DOWN key and PROFILE NUMBER will be displayed. Selections 1-16. Press the MOD key to change, then UP/DOWN to desired profile number, then press the ENTER key.

In the following paragraphs, the displayed prompts will begin with Pxx or PxxSy, where xx is the profile number and y is the segment number.

2. Press the SCROLL key to advance to the next parameter, Pxx DESCRIPTION. Selections - Text. Refer to Section 3.4.2, Changing Text, for instructions.
3. Press the SCROLL key to advance to the next parameter, Pxx SETPOINTS TO PROFILE. Selections 0-4. Press the MOD key to change, then UP/DOWN to desired number of setpoints to profile, then press the ENTER key.
4. Press the SCROLL key to advance to the next parameter, Pxx NUMBER OF SEGMENTS. Selections 1-8. Press the MOD key to change, then UP/DOWN to desired number of segments, then press the ENTER key.

THE FOLLOWING ARE REPEATED FOR EACH SEGMENT.

5. Press the SCROLL key to advance to the next parameter, PxxSy RAMP TIME, displayed as hhh:mm:ss where h is hours, m is minutes and s is seconds. Press the MOD key to change, then UP/DOWN to desired number, then press the ENTER key. NOTE: ENTER must be pressed after changing (as necessary) each unit of time; hours, minutes, and seconds.
6. Press the SCROLL key to advance to the next parameter, PxxSy SETPOINT 1. Press the MOD key to change, then UP/DOWN to desired setpoint value, then press the ENTER key.

7. Press the SCROLL key to advance to the next parameter, PxxSy SETPOINT 2 (if setpoints > 1). Press the MOD key to change, then UP/DOWN to desired setpoint value, then press the ENTER key.
8. Press the SCROLL key to advance to the next parameter, PxxSy SETPOINT 3 (if setpoints = 3 or 4). Press the MOD key to change, then UP/DOWN to desired setpoint value, then press the ENTER key.
9. Press the SCROLL key to advance to the next parameter, PxxSy SETPOINT 4 (if setpoints = 4). Press the MOD key to change, then UP/DOWN to desired setpoint value, then press the ENTER key.
10. Press the SCROLL key to advance to the next parameter, PxxSy EVENT OUTPUTS during the ramp. Eight digits will be displayed, one for each event: 0 = inactive, 1 = active. To change, press the MOD key, a cursor appears under the left most digit. Use the UP/DOWN key to change the state as necessary, then the ENTER. The cursor will move one position to the right. Repeat this procedure for each event.
11. Press the SCROLL key to advance to the next parameter, PxxSy DWELL TIME, displayed as hhh:mm:ss where h is hours, m is minutes and s is seconds. Press the MOD key to change. Changes are made the same as for Ramp Time.
12. Press the SCROLL key to advance to the next parameter, PxxSy EVENT OUTPUTS during the dwell. To change, press the MOD key.

AFTER THE SEGMENT DATA IS ENTERED, THE FOLLOWING ARE DISPLAYED FOR THE PROFILE.

13. Press the SCROLL key to advance to the next parameter, Pxx GUARANTEED SOAK. Selections NO or YES. Press the MOD key to change, then press the key directly below choice to enter.

Guaranteed Soak - If selected, this feature advances the soak time only when the process value is within the specified deviation from setpoint. Therefore it guarantees that the load is soaked at the specified setpoint. Deviation after ramp up and deviation after ramp down provides separate deviations for each direction of setpoint ramping.

14. Press the SCROLL key to advance to the next parameter, Pxx SP1 DEVIATION ON RAMP UP (only if Guaranteed Soak is set to YES). Selections 0-9999999. Press the MOD key to change, then press the LEFT/SCROLL, UP/DOWN as required to desired deviation value, then press the ENTER key.
15. Press the SCROLL key to advance to the next parameter, Pxx SP1 DEVIATION ON RAMP DOWN (only if Guaranteed Soak is set to YES). Selections 0-9999999. Press the MOD key to change, then press the LEFT/SCROLL, UP/DOWN as required to desired deviation value, then press the ENTER key.

Note: Repeated for each setpoint configured.

16. Press the SCROLL key to advance to the next parameter, Pxx SEGMENTS LOOP COUNT. Selections 0-9999. Press the MOD key to change, then the LEFT/SCROLL, UP/DOWN as required to desired loop count, then press the ENTER key.

Segment Loop Count - The unit will cycle through the segments the number of times specified by segment loop count before proceeding to the next phase, which is specified by the next parameter. One = execute the segments once.

17. Press the SCROLL key to advance to the next parameter, Pxx WHEN SEGS DONE (only seen when more than one profile has been specified). Selections: END and JOIN X (X=1-16). Press the MOD key to change, then press the LEFT/SCROLL, UP/DOWN as required to desired choice, then press the ENTER key.

When Segs Done - Profiles may be joined together to increase the number of segments or to make use of common profiling sequences. When all segments in the initiated profile have been executed the specified number of loops, the WHEN SEGS DONE parameter can "join" another profile. The instrument retains which profile was initiated, as well as which profile is currently running or "joined. When one of the profiles ends with "END", processing will revert back to the initial profile where, if Profile Loop Count is greater than one, the unit will proceed through the initial profile or terminate as specified in the initial profile.

18. Press the SCROLL key to advance to the next parameter, Pxx PROFILE LOOP COUNT. Selections 0-9999. Press the MOD key to change, then press the LEFT/SCROLL, UP/DOWN as required to desired loop count, then press the ENTER key.

Profile Loop Count - The profile loop count will appear in all profiles but only the initial profile will use the loop count. At the end of a profile the profile loop count will determine if the profile will terminate or proceed through the profile again.

19. Press the SCROLL key to advance to the next parameter, Pxx END ACTION. Selections are: OFF, EVENTS OFF (Unit turns all outputs off or 0% including the events; OFF, EVENTS SAME (Unit turns control outputs off or 0% but keeps the events in the same condition they were - on remain on; off remain off); or CONTROL, EVENTS SAME (Unit reverts to control with the events the same). Press the MOD key to change, then UP/DOWN as required to desired choice, then press the ENTER key.

20. Press the SCROLL key to advance to the next parameter, Pxx ABORT ACTION. Selections are: OFF, EVENTS OFF (Unit turns all outputs off or 0% including the events; OFF, EVENTS SAME (Unit turns control outputs off or 0% but keeps the events in the same condition they were - on remain on; off remain off); or CONTROL, EVENTS SAME (Unit reverts to control with the events the same). Press the MOD key to change, then UP/DOWN as required to desired choice, then press the ENTER key.

21. Press the SCROLL key to advance to the next parameter, Pxx POWERFAIL ACTION. Selections are: CONTINUE; HOLD; ABORT; or RESTART. Press the MOD key to change, then UP/DOWN as required to desired choice, then press the ENTER key.

22. Press the SCROLL key to advance to the next parameter, Pxx RECOVERY TIME LIMIT, displayed as hhh:mm:ss, where h is hours, m is minutes, and s is seconds. Press the MOD key to change, then UP/DOWN to desired number, then press the ENTER key. NOTE: This procedure will need to be performed for each segment of time; hours, minutes and seconds.

23. Press the SCROLL key to advance to the next parameter, Pxx RECOVERY ACTION. Selections are CONTINUE, HOLD, ABORT, or RESTART. Press the MOD key to change, then LEFT/SCROLL, UP/DOWN as required to desired choice, then press the ENTER key.

Power Failure - If power fails the unit will respond based upon the parameters specified by POWER FAIL ACTION or RECOVERY ACTION, depending on the parameter specified by RECOVERY TIME LIMIT. During profiling, the current time is saved in non-cleared memory every second. During initialization, the last time saved while the profile was running is compared to the current time. If the unit was off for a time period greater than specified by RECOVERY TIME LIMIT, RECOVERY ACTION parameter applies. If the period of time is less than the RECOVERY TIME LIMIT, POWER FAIL ACTION parameter applies.

POWER FAIL ACTION and RECOVERY ACTION specify what shall happen based upon the choice selection made:

CONTINUE requires no action, the profile will continue at the point the profile was interrupted.

HOLD will place the profile in the HOLD condition and stop in the current segment (ramp or dwell) with the time remaining for the segment held at the last value before placed into HOLD.

ABORT will terminate the current running profile.

RESTART will cause the instrument to begin the profile from the beginning.

24. Press the SCROLL key and the display advances to the next profile to be configured.

---

---

## 14.2 PROFILE SETTINGS

To enter the Profile Settings section, from the Normal Display, press the SCROLL key until CONFIGURATION appears in the lower display line. With CONFIGURATION in the lower display line, press the DOWN key. Press the SCROLL key until PROFILE SETTINGS appears in the lower display line.

1. With PROFILE SETTINGS in the lower display line, press the DOWN key, then the SCROLL key until PROFILE ENTRY appears in the upper display line. Selections are: DISABLED DURING RUN or ENABLE DURING RUN. Press the MOD key to change, then UP/DOWN as required to desired choice, then press the ENTER key.

Profile Entry - This parameter controls access to the PROFILE ENTRY section while the profile is running; DISABLED prevents access while ENABLED allows access.

2. Press the SCROLL key to advance to the next parameter, PROFILE START ACTUATOR. See Actuator List for selections. Press the MOD key to change, then LEFT/SCROLL, UP/DOWN as required to desired choice, then press the ENTER key.

Profile Start Actuator - A transition from not active to active of the PROFILE START ACTUATOR will initiate the selected profile.

3. Press the SCROLL key to advance to the next parameter, PROFILE SELECTOR. See Choice List for selections. Press the MOD key to change, then LEFT/SCROLL, UP/DOWN as required to desired choice, then press the ENTER key.

Profile Selector - Applies only when the PROFILE START ACTUATOR is used, and allows an analog value, typically from an IV, to select the profile number to be initiated. Care must be taken to insure that a valid value is provided. The value is automatically rounded to the nearest whole number.

4. Press the SCROLL key to advance to the next parameter, PROFILE ABORT ACTUATOR. See Actuator List for selections. Press the MOD key to change, then LEFT/SCROLL, UP/DOWN as required to desired choice, then press the ENTER key.

Profile Abort Actuator - If a transition is detected on the Profile Abort Actuator and a profile is active, the profile is then aborted.

5. Press the SCROLL key to advance to the next parameter, PROFILE HOLD ACTUATOR. See Actuator List for selections. Press the MOD key to change, then LEFT/SCROLL, UP/DOWN as required to desired choice, then press the ENTER key.

Profile Hold Actuator - A positive transition of the Profile Hold Actuator places an active profile in hold, while a negative transition places it in run. While in hold, the ramp/dwell timer stops.

6. Press the SCROLL key to advance to the next parameter, PROFILE ADVANCE ACTUATOR. See Actuator List for selections. Press the MOD key to change, then LEFT/SCROLL, UP/DOWN as required to desired choice, then press the ENTER key.

Profile Advance Actuator - A positive transition on the Profile Advance actuator will advance the profile to the next step. The ramp time remaining or dwell time remaining will be set with a few seconds so that the profile will step quickly to the next segment, yet do so without abruptly changing the current segment or profile.



7. Press the SCROLL key to advance to the next parameter, PROFILE DISPLAY OPTION. Selections are: NOT DISPLAYED; IN CONTINUOUS MODE; IN SEQUENTIAL MODE; or IN BOTH MODES. Press the MOD key to change, then UP/DOWN to desired choice, then press the ENTER key.

If one of the DISPLAY option is selected, the parameters displayed are as follows:

START PROFILE number  
description

CURRENT PROFILE number  
description

status  
status

CURRENT SEGMENT  
NUMBER number

RAMP TIME hhh:mm:ss  
DWELL hhh:mm:ss

EVENT 12345678  
OUTPUTS ssssssss

setpoint description (may be up to four and only if configured to be displayed in  
setpoint value SETPOINT Configuration.)

status - The top display line displays whether the profile is RUNNING, HOLDING, or AUTO HOLDING. The bottom display line displays if the profile is RAMPING or in DWELL.

8. Press the SCROLL key and the display advances back to the beginning of Profile Settings.

When Profiling is included in an instrument, several actuators are added to the choice list as indicated in **bold** in the list below.

ACTUATOR LIST

NONE/OFF  
ON/CONTINUOUS  
**ANY\_ALARM**  
**ANY\_PROCESS\_ALARM**  
**A11 A12 A13 A14**  
**A21 A22 A23 A24**  
**A31 A32 A33 A34**  
**A41 A42 A43 A44**  
**INSTRUMENT\_ALARM**  
**CHART\_FULL**  
OP\_INP\_1 OP\_INP\_2  
OP\_INP\_3 OP\_INP\_4  
OP\_INP\_5 OP\_INP\_6  
OP\_INP\_7 OP\_INP\_8  
OP\_INP\_9 OP\_INP\_10  
OP\_INP\_11 OP\_INP\_12  
**CHART\_CHANGED**  
**CHART\_ROTATION**  
**TREND\_DATA\_COLLECT**  
**DA1 DA2 DA3**

DA4 DA5 DA6  
 DA7 DA8 DA9  
 DA10 DA11 DA12  
 DA13 DA14 DA15  
 DA16 DA17 DA18  
 DA19 DA20 DA21  
 DA22 DA23 DA24  
 OUTPUT\_11 OUTPUT\_12  
 OUTPUT\_21 OUTPUT\_22  
 OUTPUT\_31 OUTPUT\_32  
 OUTPUT\_41 OUTPUT\_42  
 EVENT\_1 EVENT\_2  
 EVENT\_3 EVENT\_4  
 EVENT\_5 EVENT\_6  
 EVENT\_7 EVENT\_8  
 PRESET\_1 PRESET\_2  
 PRESET\_3 PRESET\_4  
 TOTAL\_PO1 TOTAL\_PO2  
 TOTAL\_PO3 TOTAL\_PO4  
 TIME\_1 TIME/DATE\_1  
 TIME\_2 TIME/DATE\_2  
 TIME\_1\_TO\_TIME\_2  
 TIME/DATE\_1\_TO\_2  
 TIMER\_1 TIMER\_2  
 TIMER\_3 TIMER\_4  
 SW1 SW2 SW3 SW4  
 SW5 SW6 SW7 SW8  
 COMM\_TRIGGER\_1  
 COMM\_TRIGGER\_2  
 COMM\_TRIGGER\_3  
 COMM\_TRIGGER\_4  
 F1 F2 F3 F4 F5  
 RESET MOD ENTER  
 ON\_THE\_HOUR  
 ON\_THE\_WEEK  
 DAY\_OF\_MONTH  
 RELAY\_1 RELAY\_2  
 RELAY\_3 RELAY\_4  
 RELAY\_5 RELAY\_6  
 RELAY\_7 RELAY\_8  
 CA1F1 CA1F2 CA1C3  
 CA1F4 CA1F5  
 CA2F1 CA2F2 CA2C3  
 CA2F4 CA2F5  
 CA3F1 CA3F2 CA3C3  
 CA3F4 CA3F5  
 CA4F1 CA4F2 CA4C3  
 CA4F4 CA4F5  
 POWER\_FAILED  
 PROFILE\_ACTIVE  
 PROFILE\_COMPLETE  
 PROFILE\_ABORTED  
 PROFILE\_HOLDING  
 PROFILE\_AUTO\_HOLDING  
 PROFILE\_OFF/CONTROL

**PROFILE ACTIVE** is true whenever a profile is running or holding; not aborted or complete. **PROFILE COMPLETE** is true when a profile has run to completion. **PROFILE ABORTED** is true whenever a profile has been aborted. **PROFILE HOLDING** and **(time not advancing)** and **PROFILE AUTO HOLDING** (holding due to deviation hold after ramping) are self explanatory. The **PROFILE OFF/CONTROL** actuator is controlled by the **END ACTION**, **ABORT ACTION**, and **POWERFAIL ACTION** choices, whenever a profile completes, is aborted, or power fails, respectively. When this capability is desired, the **PROFILE OFF/CONTROL** actuator must be selected for the **CONTROL ON ACTUATOR**, which is located in the Instrument Settings section.

---

## 14.3 PROFILE CONTROL

To enter the Profile Control section, from the Normal Display, press the DISP key until SELECT appears in the upper display line and PROFILE CONTROL appears in the lower display line. If PROFILE CONTROL is not displayed, then Profile Control has been disabled. Refer to Section 9, Enables and Passwords, for instructions to enable Profile Control.

1. With PROFILE CONTROL displayed, press the DOWN key and START PROFILE will be displayed. Selections are PROF 1 through PROF 16 and CONTROL ON. To change, press the MOD key, then UP/DOWN as required to desired choice, then press the ENTER key.

Start Profile - The profile to start can be derived from the result of the PROFILE START actuator positive transition (See PROFILE START ACTUATOR in PROFILE SETTINGS) that takes the value of the PROFILE SELECTOR value or the START PROFILE NUMBER entered above. Only available if profile is not already running.

2. Press the SCROLL key to advance to the next parameter, START DESCRIPTION. This is a READ ONLY parameter.

Start Description - Start description corresponds to the PROFILE DESCRIPTION under the PROFILE ENTRY menu for the selected profile.

3. Press the SCROLL key to advance to the next parameter, PROFILE START/STOP. Displayed in Automatic Modify Mode, AMM, selections are ABORT/STOP or RUN/START. Press the key directly below the choice to enter.

4. Press the SCROLL key to advance to the next parameter, PROFILE RUN/HOLD (only seen if RUN/START selected above). Displayed in AMM, selections are RUN or HOLD. Press the key directly below the choice to enter.

Profile Run/Hold - A profile put into HOLD will stop the ramp or dwell segment currently running. If the profiler is in HOLD no action is taken. If RUN is selected, a profile in HOLD will resume from the current profile, segment and time selected. If the profiler is in RUN when RUN is selected, no action is taken.

5. Press the SCROLL key to advance to the next parameter, CURRENT PROFILE. Selections are 1 to 16. Press the MOD key to change, then press the UP/DOWN as required to desired choice, then press the ENTER key.

Current Profile - If a profile is not running, this parameter can be modified to change the current active profile. When RUN is selected under PROFILE RUN/HOLD, the profiler will begin running the current profile selected.

6. Press the SCROLL key to advance to the next parameter, CURRENT DESCRIPTION. This is a READ ONLY parameter.

Current Description - The current description corresponds to the profile description entered under PROFILE ENTRY.

7. Press the SCROLL key to advance to the next parameter, CURRENT SEGMENT. Selections are 1-8. Press the MOD key to change, then the UP/DOWN as required to the desired choice, then press the ENTER key. Only modifiable if profile is presently not running.

Current Segment - This is the current active segment, which can be modified if the profile is not active. When RUN is selected under PROFILE RUN/HOLD the profiler will begin running from the current profile and the new current segment entered.

8. Press the SCROLL key to advance to the next parameter, RAMP TIME REMAINING. Only modifiable if profile is presently not running.

9. Press the SCROLL key to advance to the next parameter, DWELL TIME REMAINING. Only modifiable if profile is presently not running.

Ramp/Dwell Time Remaining - These parameters may be modified if the profile is not active. When RUN is selected under PROFILE RUN/HOLD, the profiler will begin running from the current profile, current segment using the new RAMP and/or DWELL time. If the profile is active and updating the ramp or dwell time the value displayed when first entering the menu will be the last value read.

10. Press the SCROLL key to advance to the next parameter, EVENT OUTPUTS. Under each event number is the current state, 0 or 1. Selections are "0" or "1"; "0" is not active and "1" is active.

Event Outputs - Event Outputs can always be modified. Event outputs represent the current active segment ramp or dwell.

11. Press the SCROLL key to advance to the next parameter, PROFILE STATUS ACTION (only seen if profile has been aborted). Displayed in AMM, selections are ABORTED or CONTINUE. Press the key directly below the choice to desired.

Profile Status/Action - If a profile has been aborted the profile can be continued using the choice CONTINUE.

12. Press the SCROLL key and the display returns back to START PROFILE.

PROFILE NUMBER				
Parameter	P 1	P 2	P 3	P 4
DESCRIPTION SETPOINTS TO PROFILE NUMBER OF SEGMENTS				
SEGMENT 1 RAMP TIME hhh:mm:ss SETPOINT 1 SETPOINT 2 SETPOINT 3 SETPOINT 4 EVENT OUTPUTS -RAMP DWELL TIME hhh:mm:ss EVENT OUTPUTS - DWELL				
SEGMENT 2 RAMP TIME hhh:mm:ss SETPOINT 1 SETPOINT 2 SETPOINT 3 SETPOINT 4 EVENT OUTPUTS - RAMP DWELL TIME hhh:mm:ss EVENT OUTPUTS - DWELL				
SEGMENT 3 RAMP TIME hhh:mm:ss SETPOINT 1 SETPOINT 2 SETPOINT 3 SETPOINT 4 EVENT OUTPUTS - RAMP DWELL TIME hhh:mm:ss EVENT OUTPUTS - DWELL				
SEGMENT 4 RAMP TIME hhh:mm:ss SETPOINT 1 SETPOINT 2 SETPOINT 3 SETPOINT 4 EVENT OUTPUTS - RAMP DWELL TIME hhh:mm:ss EVENT OUTPUTS - DWELL				
SEGMENT 5 RAMP TIME hhh:mm:ss SETPOINT 1 SETPOINT 2 SETPOINT 3 SETPOINT 4 EVENT OUTPUTS - RAMP DWELL TIME hhh:mm:ss EVENT OUTPUTS - DWELL				

PROFILE NUMBER				
Parameter	P 1	P 2	P 3	P 4
SEGMENT 6 RAMP TIME hhh:mm:ss SETPOINT 1 SETPOINT 2 SETPOINT 3 SETPOINT 4 EVENT OUTPUTS - RAMP DWELL TIME hhh:mm:ss EVENT OUTPUTS - DWELL				
SEGMENT 7 RAMP TIME hhh:mm:ss SETPOINT 1 SETPOINT 2 SETPOINT 3 SETPOINT 4 EVENT OUTPUTS - RAMP DWELL TIME hhh:mm:ss EVENT OUTPUTS - DWELL				
SEGMENT 8 RAMP TIME hhh:mm:ss SETPOINT 1 SETPOINT 2 SETPOINT 3 SETPOINT 4 EVENT OUTPUTS - RAMP DWELL TIME hhh:mm:ss EVENT OUTPUTS - DWELL GUARANTEED SOAK SP1 DEVIATION RAMP UP SP1 DEVIATION RAMP DN SP2 DEVIATION RAMP UP SP2 DEVIATION RAMP DN SP3 DEVIATION RAMP UP SP3 DEVIATION RAMP DN SP4 DEVIATION RAMP UP SP4 DEVIATION RAMP DN SEGMENTS LOOP COUNT WHEN SEGMENTS DONE PROFILE LOOP COUNT END ACTION				
PROFILE NUMBER				
Parameter	P 1	P 2	P 3	P 4
ABORT ACTION POWER FAIL ACTION RECOVERY TIME LIMIT RECOVERY ACTION				

PROFILE NUMBER				
Parameter	P 5	P 6	P 7	P 8
DESCRIPTION SETPOINTS TO PROFILE NUMBER OF SEGMENTS				
SEGMENT 1 RAMP TIME hhh:mm:ss SETPOINT 1 SETPOINT 2 SETPOINT 3 SETPOINT 4 EVENT OUTPUTS - RAMP DWELL TIME hhh:mm:ss EVENT OUTPUTS - DWELL				
SEGMENT 2 RAMP TIME hhh:mm:ss SETPOINT 1 SETPOINT 2 SETPOINT 3 SETPOINT 4 EVENT OUTPUTS - RAMP DWELL TIME hhh:mm:ss EVENT OUTPUTS - DWELL				
SEGMENT 3 RAMP TIME hhh:mm:ss SETPOINT 1 SETPOINT 2 SETPOINT 3 SETPOINT 4 EVENT OUTPUTS - RAMP DWELL TIME hhh:mm:ss EVENT OUTPUTS - DWELL				
SEGMENT 4 RAMP TIME hhh:mm:ss SETPOINT 1 SETPOINT 2 SETPOINT 3 SETPOINT 4 EVENT OUTPUTS - RAMP DWELL TIME hhh:mm:ss EVENT OUTPUTS - DWELL				
SEGMENT 5 RAMP TIME hhh:mm:ss SETPOINT 1 SETPOINT 2 SETPOINT 3 SETPOINT 4 EVENT OUTPUTS - RAMP DWELL TIME hhh:mm:ss EVENT OUTPUTS - DWELL				

PROFILE NUMBER				
Parameter	P 5	P 6	P 7	P 8
SEGMENT 6 RAMP TIME hhh:mm:ss SETPOINT 1 SETPOINT 2 SETPOINT 3 SETPOINT 4 EVENT OUTPUTS - RAMP DWELL TIME hhh:mm:ss EVENT OUTPUTS - DWELL				
SEGMENT 7 RAMP TIME hhh:mm:ss SETPOINT 1 SETPOINT 2 SETPOINT 3 SETPOINT 4 EVENT OUTPUTS - RAMP DWELL TIME hhh:mm:ss EVENT OUTPUTS - DWELL				
SEGMENT 8 RAMP TIME hhh:mm:ss SETPOINT 1 SETPOINT 2 SETPOINT 3 SETPOINT 4 EVENT OUTPUTS - RAMP DWELL TIME hhh:mm:ss EVENT OUTPUTS - DWELL GUARANTEED SOAK SP1 DEVIATION RAMP UP SP1 DEVIATION RAMP DN SP2 DEVIATION RAMP UP SP2 DEVIATION RAMP DN SP3 DEVIATION RAMP UP SP3 DEVIATION RAMP DN SP4 DEVIATION RAMP UP SP4 DEVIATION RAMP DN SEGMENTS LOOP COUNT WHEN SEGMENTS DONE PROFILE LOOP COUNT END ACTION				
PROFILE NUMBER				
Parameter	P 5	P 6	P 7	P 8
ABORT ACTION POWER FAIL ACTION RECOVERY TIME LIMIT RECOVERY ACTION				



PROFILE NUMBER				
Parameter	P 9	P 10	P 11	P 12
DESCRIPTION SETPOINTS TO PROFILE NUMBER OF SEGMENTS				
SEGMENT 1 RAMP TIME hhh:mm:ss SETPOINT 1 SETPOINT 2 SETPOINT 3 SETPOINT 4 EVENT OUTPUTS -RAMP DWELL TIME hhh:mm:ss EVENT OUTPUTS - DWELL				
SEGMENT 2 RAMP TIME hhh:mm:ss SETPOINT 1 SETPOINT 2 SETPOINT 3 SETPOINT 4 EVENT OUTPUTS - RAMP DWELL TIME hhh:mm:ss EVENT OUTPUTS - DWELL				
SEGMENT 3 RAMP TIME hhh:mm:ss SETPOINT 1 SETPOINT 2 SETPOINT 3 SETPOINT 4 EVENT OUTPUTS - RAMP DWELL TIME hhh:mm:ss EVENT OUTPUTS - DWELL				
SEGMENT 4 RAMP TIME hhh:mm:ss SETPOINT 1 SETPOINT 2 SETPOINT 3 SETPOINT 4 EVENT OUTPUTS - RAMP DWELL TIME hhh:mm:ss EVENT OUTPUTS - DWELL				
SEGMENT 5 RAMP TIME hhh:mm:ss SETPOINT 1 SETPOINT 2 SETPOINT 3 SETPOINT 4 EVENT OUTPUTS - RAMP DWELL TIME hhh:mm:ss EVENT OUTPUTS - DWELL				

PROFILE NUMBER				
Parameter	P 9	P 10	P 11	P 12
SEGMENT 6 RAMP TIME hhh:mm:ss SETPOINT 1 SETPOINT 2 SETPOINT 3 SETPOINT 4 EVENT OUTPUTS - RAMP DWELL TIME hhh:mm:ss EVENT OUTPUTS - DWELL				
SEGMENT 7 RAMP TIME hhh:mm:ss SETPOINT 1 SETPOINT 2 SETPOINT 3 SETPOINT 4 EVENT OUTPUTS - RAMP DWELL TIME hhh:mm:ss EVENT OUTPUTS - DWELL				
SEGMENT 8 RAMP TIME hhh:mm:ss SETPOINT 1 SETPOINT 2 SETPOINT 3 SETPOINT 4 EVENT OUTPUTS - RAMP DWELL TIME hhh:mm:ss EVENT OUTPUTS - DWELL GUARANTEED SOAK SP1 DEVIATION RAMP UP SP1 DEVIATION RAMP DN SP2 DEVIATION RAMP UP SP2 DEVIATION RAMP DN SP3 DEVIATION RAMP UP SP3 DEVIATION RAMP DN SP4 DEVIATION RAMP UP SP4 DEVIATION RAMP DN SEGMENTS LOOP COUNT WHEN SEGMENTS DONE PROFILE LOOP COUNT END ACTION				
PROFILE NUMBER				
Parameter	P 9	P 10	P 11	P 12
ABORT ACTION POWER FAIL ACTION RECOVERY TIME LIMIT RECOVERY ACTION				

PROFILE NUMBER				
Parameter	P 13	P 14	P 15	P 16
DESCRIPTION SETPOINTS TO PROFILE NUMBER OF SEGMENTS				
SEGMENT 1 RAMP TIME hhh:mm:ss SETPOINT 1 SETPOINT 2 SETPOINT 3 SETPOINT 4 EVENT OUTPUTS -RAMP DWELL TIME hhh:mm:ss EVENT OUTPUTS - DWELL				
SEGMENT 2 RAMP TIME hhh:mm:ss SETPOINT 1 SETPOINT 2 SETPOINT 3 SETPOINT 4 EVENT OUTPUTS - RAMP DWELL TIME hhh:mm:ss EVENT OUTPUTS - DWELL				
SEGMENT 3 RAMP TIME hhh:mm:ss SETPOINT 1 SETPOINT 2 SETPOINT 3 SETPOINT 4 EVENT OUTPUTS - RAMP DWELL TIME hhh:mm:ss EVENT OUTPUTS - DWELL				
SEGMENT 4 RAMP TIME hhh:mm:ss SETPOINT 1 SETPOINT 2 SETPOINT 3 SETPOINT 4 EVENT OUTPUTS - RAMP DWELL TIME hhh:mm:ss EVENT OUTPUTS - DWELL				
SEGMENT 5 RAMP TIME hhh:mm:ss SETPOINT 1 SETPOINT 2 SETPOINT 3 SETPOINT 4 EVENT OUTPUTS - RAMP DWELL TIME hhh:mm:ss EVENT OUTPUTS - DWELL				

PROFILE NUMBER				
Parameter	P 13	P 14	P 15	P 16
SEGMENT 6 RAMP TIME hhh:mm:ss SETPOINT 1 SETPOINT 2 SETPOINT 3 SETPOINT 4 EVENT OUTPUTS - RAMP DWELL TIME hhh:mm:ss EVENT OUTPUTS - DWELL				
SEGMENT 7 RAMP TIME hhh:mm:ss SETPOINT 1 SETPOINT 2 SETPOINT 3 SETPOINT 4 EVENT OUTPUTS - RAMP DWELL TIME hhh:mm:ss EVENT OUTPUTS - DWELL				
SEGMENT 8 RAMP TIME hhh:mm:ss SETPOINT 1 SETPOINT 2 SETPOINT 3 SETPOINT 4 EVENT OUTPUTS - RAMP DWELL TIME hhh:mm:ss EVENT OUTPUTS - DWELL GUARANTEED SOAK SP1 DEVIATION RAMP UP SP1 DEVIATION RAMP DN SP2 DEVIATION RAMP UP SP2 DEVIATION RAMP DN SP3 DEVIATION RAMP UP SP3 DEVIATION RAMP DN SP4 DEVIATION RAMP UP SP4 DEVIATION RAMP DN SEGMENTS LOOP COUNT WHEN SEGMENTS DONE PROFILE LOOP COUNT END ACTION				
PROFILE NUMBER				
Parameter	P 13	P 14	P 15	P 16
ABORT ACTION POWER FAIL ACTION RECOVERY TIME LIMIT RECOVERY ACTION				

Parameter

PROFILE ENTRY	DISABLED DURING RUN	ENABLED DURING RUN
PROF START ACTUATOR		
PROFILE SELECTOR		
PROF ABORT ACTUATOR		
PROF HOLD ACTUATOR		
PROF ADVANCE ACTUATR		
PROF DISPLAY OPTION		

# Appendix A - Board Layouts

FIGURE A-1 POWER SUPPLY BOARD

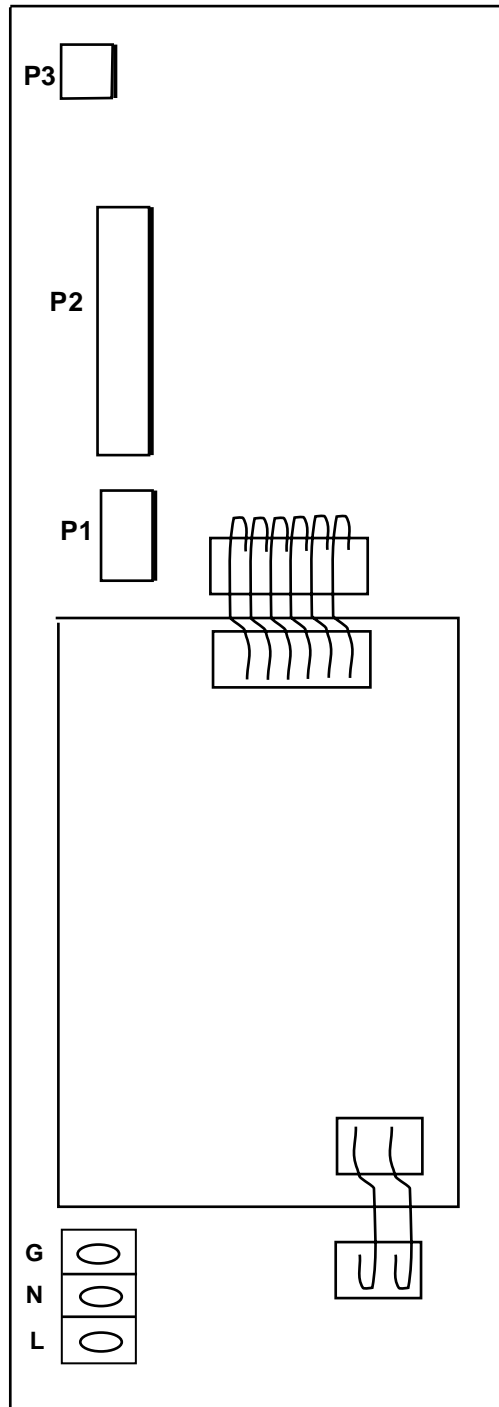

FIGURE A-2 MOTHER BOARD

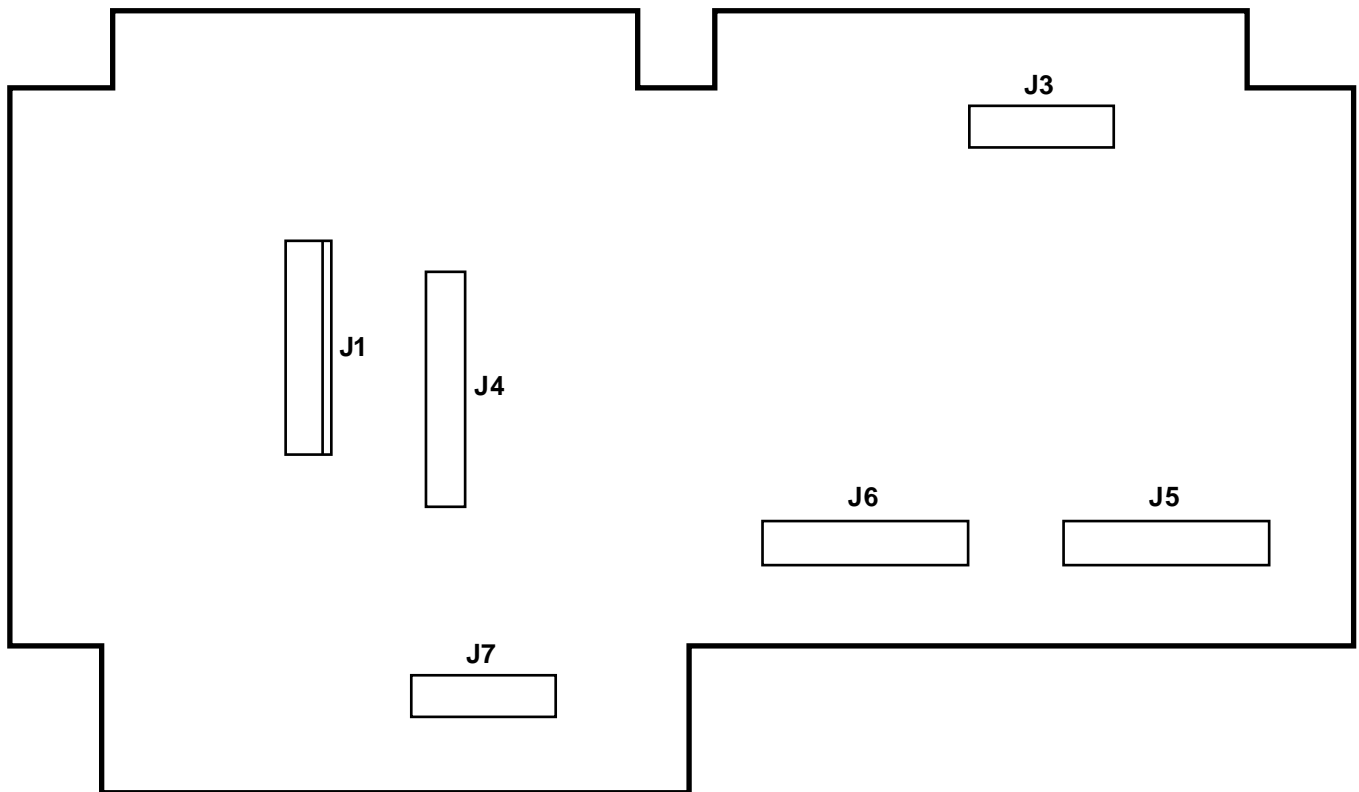

FIGURE A-3 RELAY/SSR BOARD

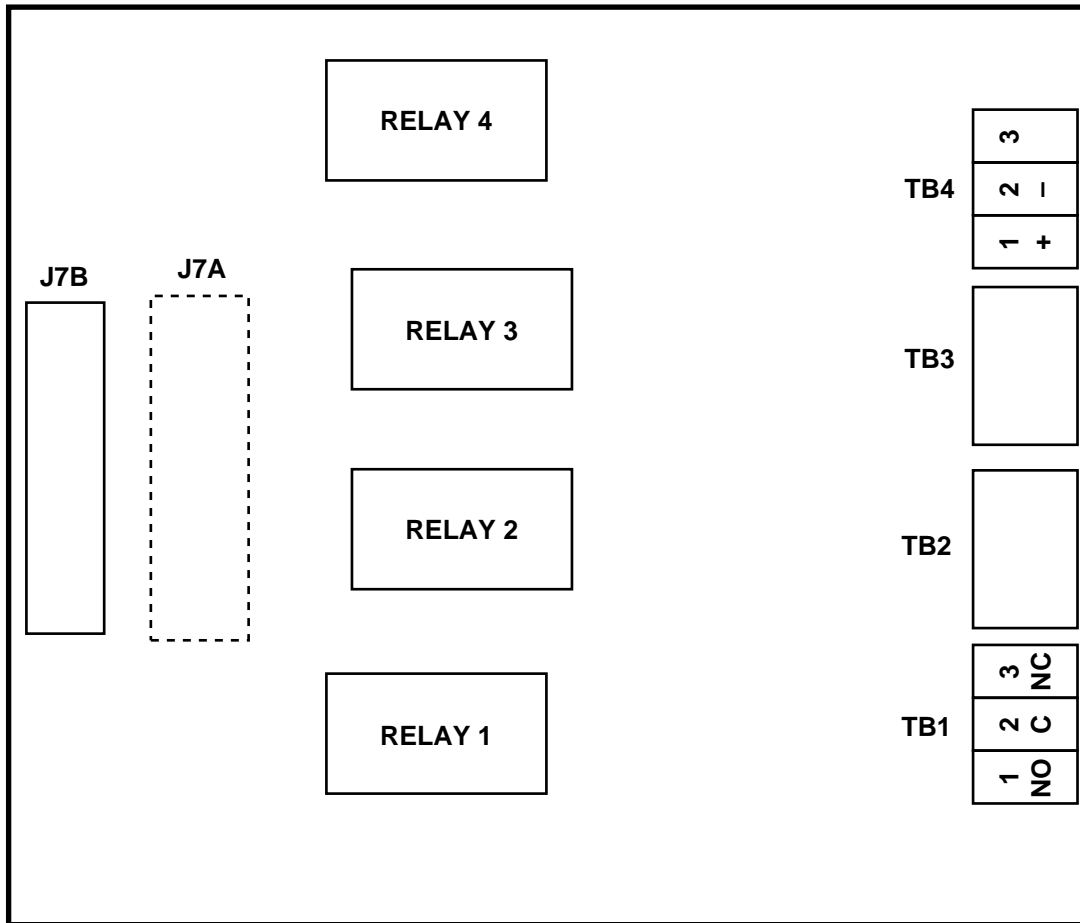
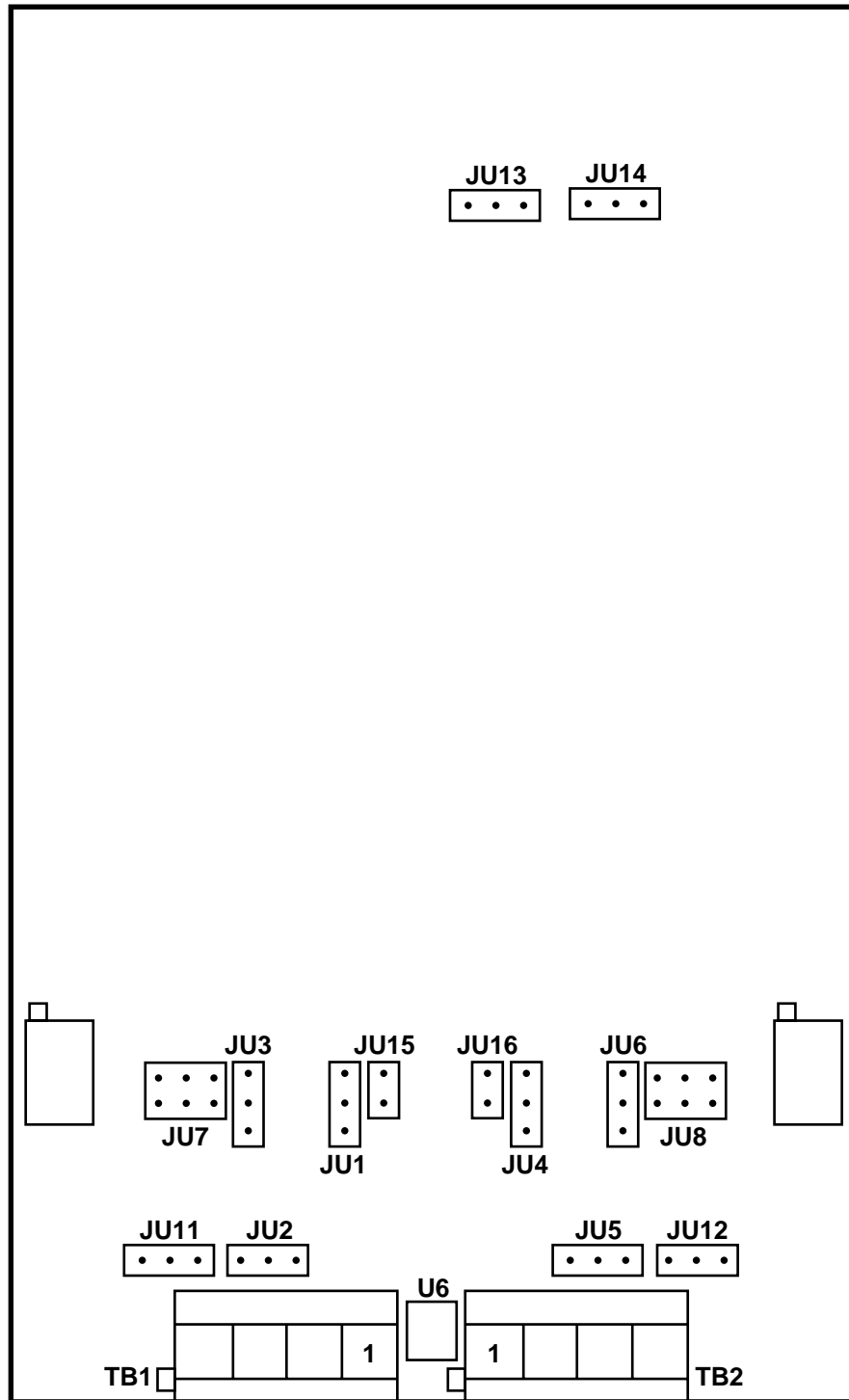
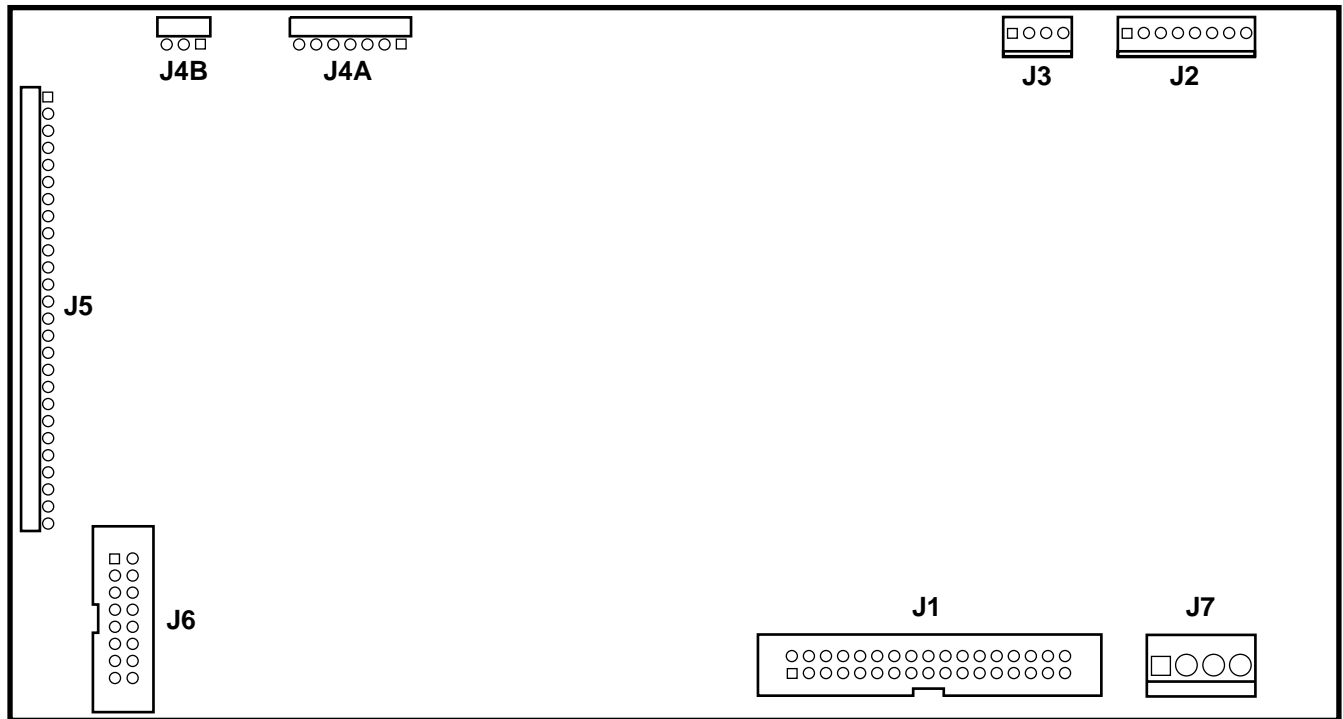



FIGURE A-4 INPUT BOARD



**FIGURE A-5 MOTOR DRIVER BOARD**



**FIGURE A-6 CURRENT OUTPUT BOARD**

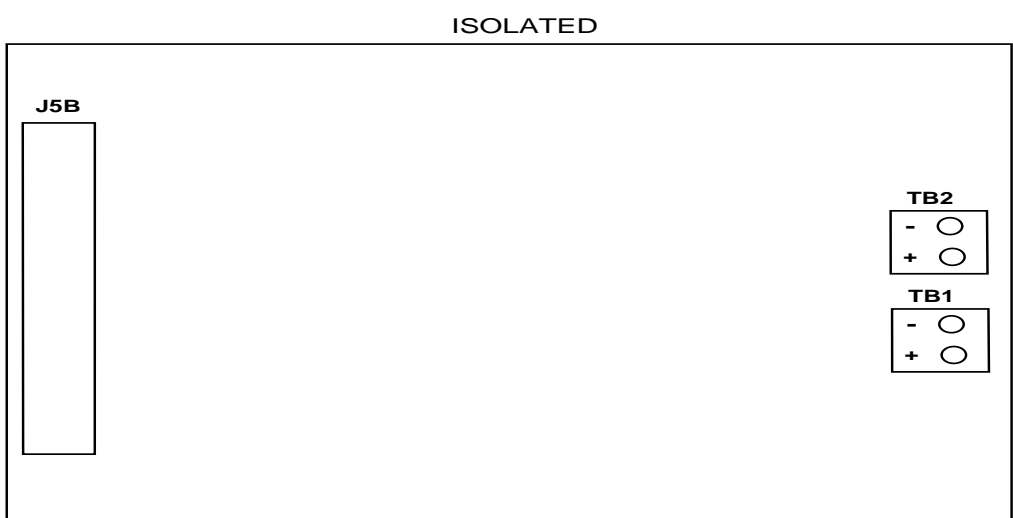
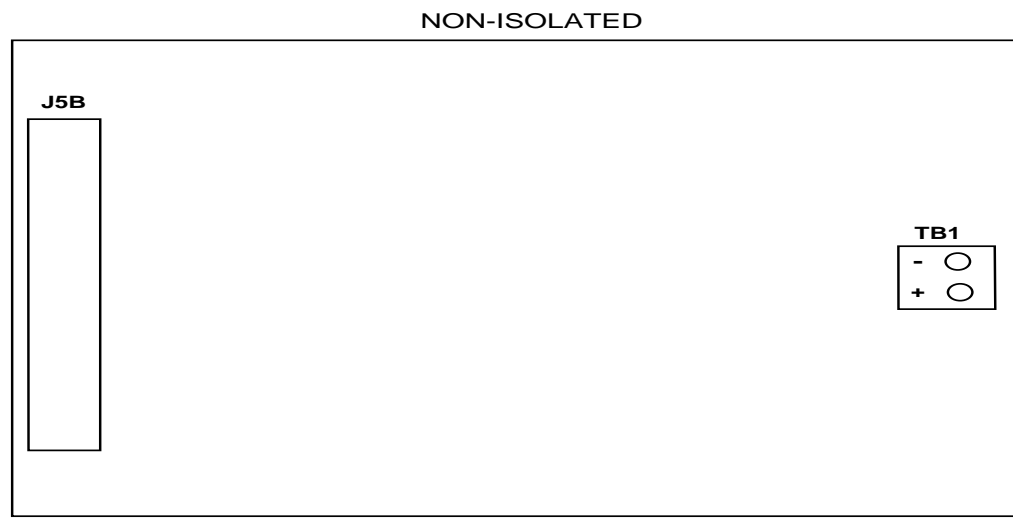
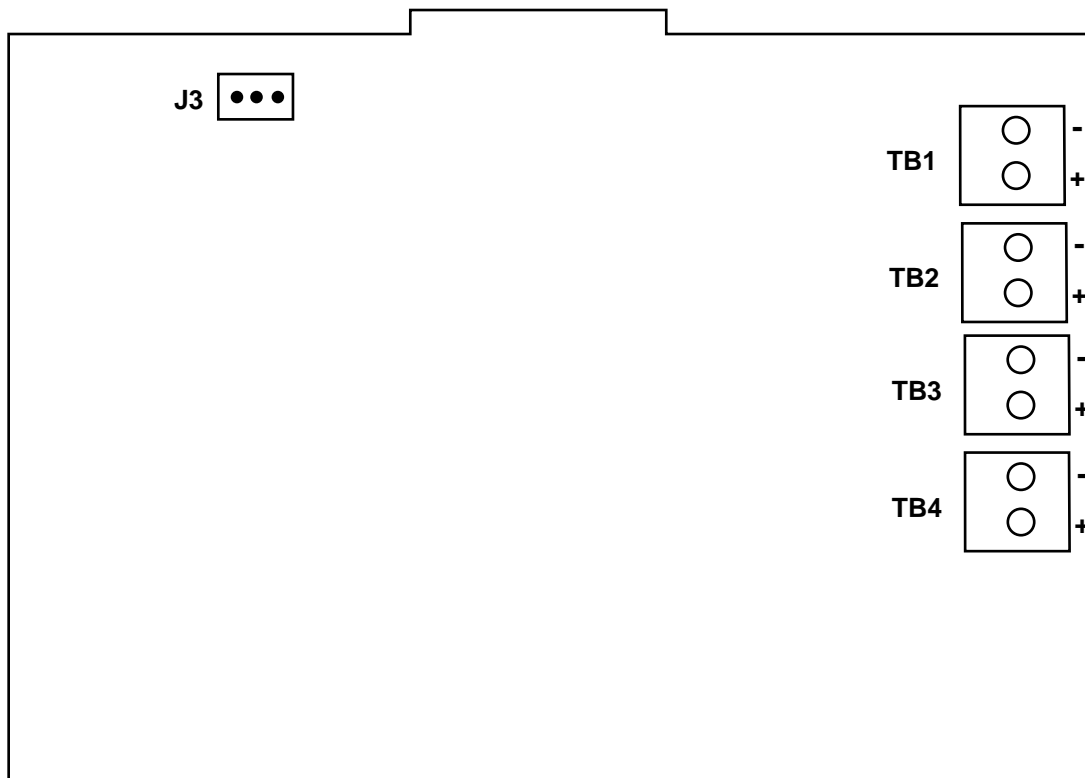
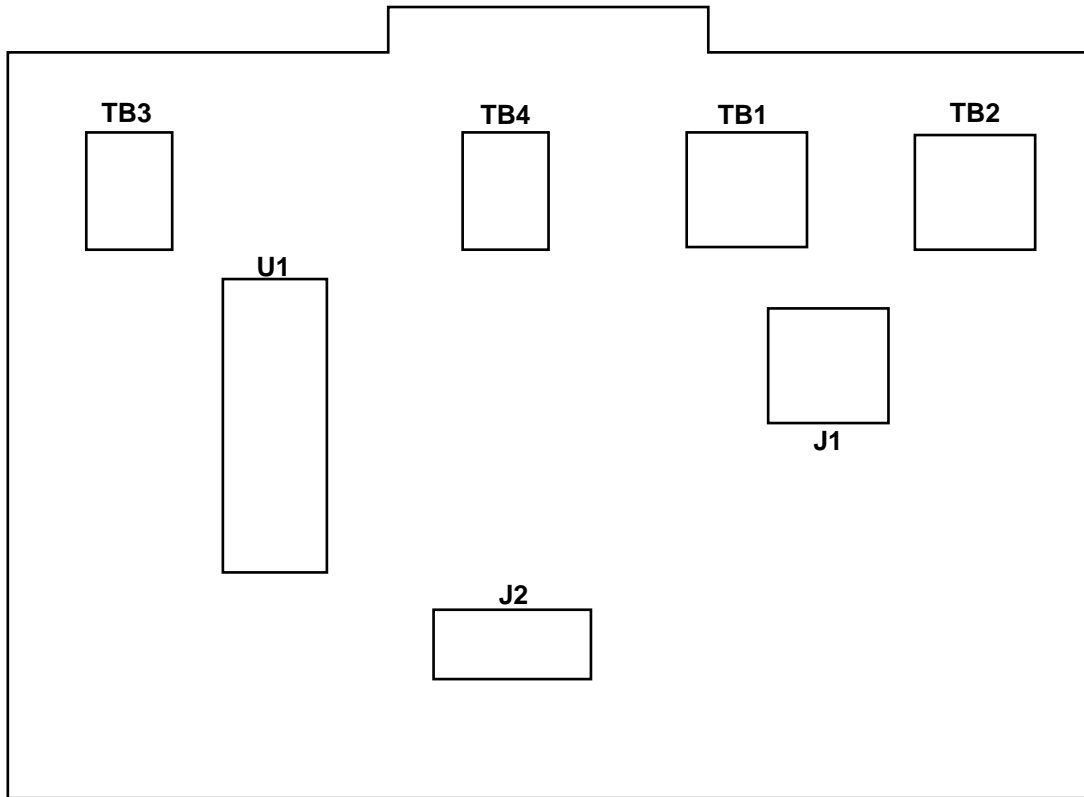

FIGURE A-7 TRANSMITTER POWER SUPPLY BOARD



**FIGURE A-8 COMMS BOARD**



**TB1 - 232 Main  
TB2 - 232 Aux**

**TB3 - 485 Main  
TB4 - 485 Aux**

---

## Appendix B - Ranges

### THERMOCOUPLE

<u>JU7/JU8 POSITION</u>	<u>TYPE</u>	<u>OPERATING RANGE</u>
Wide	J	-200°C to 760°C -328°F to 1400°F
Narrow	J	-200°C to 450°C -328°F to 842°F
Wide	K	-250°C to 1370°C -418°F to 2498°F
Narrow	K	-250°C to 600°C 418°F to 1112°F
Wide	E	-250°C to 1000°C -418°F to 1832°F
Narrow	E	-250°C to 350°C -418°F to 663°F
Wide	N	-270°C to 1300°C -441°F to 2373°F
Narrow	N	-270°C to 700°C -441°F to 1292°F
Wide	G	0°C to 2300°C 32°F to 4172°F
Wide	C	0°C to 2300°C 32°F to 4172°F
Wide	D	0°C to 2300°C 32°F to 4172°F
Wide	NNM	0°C to 1400°C 32°F to 2552°F
Wide	PLII	0°C to 1400°C 32°F to 2552°F
Narrow	T	-250°C to 400°C -421°F to 753°F
Narrow	R	*200°C to 1750°C 400°F to 3128°F
Narrow	S	*200°C to 1750°C 400°F to 3182°F
Narrow	B	*200°C to 1800°C 400°F to 3272°F

\*Actual minimum of span is 0°C to prevent "LO" error condition during initial start-up at room ambient.

## RTD

<u>JU7/JU8 POSITION</u>	<u>TYPE</u>	<u>OPERATING RANGE</u>
Low	Platinum 100 ohm .00385 Din	-200°C to 480°C -328°F to 896°F
Low	Platinum 100 Ohm .00392 USA	-100°C to 450°C -148°F to 842°F
Low	Platinum 100 Ohm .00392 SAMA	-200°C to 560°C -328°F to 1040°F
Low	Nickel 100 Ohm	-40°C to 200°C -40°F to 392°F

---

## Appendix C - Reference Section

Next to each term is the prompt section it appears in, as appropriate, and the applicable section or page of this manual. Terms that are printed in all upper case letters appear in the instruments display, or are keypad designations. In some cases, additional words are inserted for readability.

While many of the terms listed are actually the prompt shown on the first line, the definition refers to the corresponding parameter value, choice, or text. Some prompts appear multiple times in a section or in multiple sections, with each occurrence having a separate value associated with it.

### **ACTION ON NEW CHART** - Chart Configuration - Page 6-11

Specifies the action the recorder takes when a new chart is installed; NONE - JUST CONTINUE trending, PRINT a RANGE LIST first, or PRINT a set of SCALES for each pen first.

### **ACTION TIME SETTINGS** - System Prompts - Section 8

Prompt section where values are entered in Time and Date parameters which are used to generate the following actuators: TIME 1, TIME/DATE 1, TIME 2, TIME/DATE 2, TIME1 TO TIME 2, and TIME/DATE 1 TO 2. The TIME1 and TIME 2 actuators are true when the time is equal to or greater than the time values during each 24 hour day, and false between midnight and the time specified. The TIME/DATE 1 and TIME/DATE 2 actuators are true when the time and date are equal to or greater than the time and date values specified, and remain true into the future. TIME 1 TO TIME 2 is true when the time is equal to or greater than the TIME 1 parameter and less than or equal to TIME 2 parameter during the next 24 hour period.

Examples:        If TIME 1 is set to 8 AM and TIME 2 is set to 4 PM,  
                         then TIME 1 TO TIME 2 is true for 8 hours during the day.  
                         If TIME 1 is set to 10 PM and TIME 2 is set to 6 AM,  
                         then TIME 1 TO TIME 2 is true for 8 hours running through midnight.

### **Actuators**

Digital values (considered to be 1 or 0, true or false, active or inactive) available as choice selections for various parameters, used to cause some action to occur. For example, A23 is the designation for third alarm on PV2 (Process Variable 2). When PV2 is in alarm, A23 will be 1, true, or active, and if a relay has been configured to be activated by A23, the relay would be energized.

### **ALARM SETTINGS** - System Prompts - Section 7

Prompt section containing parameters which specify the setpoint of each alarm configured within the Process Variables section of Configuration.

### **ALARMS ON ACTUATOR** - System Prompts - Configuration - Instrument Settings - Page 4-74

Parameter that selects an actuator which controls whether process alarming is active. When inactive, all process alarms (A11 through A44) are reset and ignored.

### **ALARM TYPE** - System Prompts - Configuration - Process Variables - Page 4-36

Parameter that specifies the type of alarm: PROCESS HIGH, PROCESS LOW, RATE RAISING, etc.

### **ALT SPEED ACTUATOR** - Chart Prompts - Chart Configuration - Page 6-6

Parameter that specifies an actuator that, when active, switches the chart speed from the NORMAL SPEED to the ALTERNATE SPEED.

### **AT VALUE** - System Prompts - Configuration - Inputs - Page 4-10

One of the choices for CUTOFF TYPE which specifies that the resultant IV (Input Value) is set to the CUTOFF VALUE whenever the input valve is less than the CUTOFF VALUE. The CUTOFF VALUE may be positive or negative, allowing cutoff to occur at any point.



**AVERAGE VALUES** - System Prompts - Configuration - Recorders - Page 4-46

The choice for the parameter RECORDING METHOD that prints a single dot corresponding to the average of the trended value during the “print interval”. This method records a series of dots which may not form a continuous trend line.

**BACKGROUND** - System Prompts - Configuration - Operator Messages - Page 4-88

A choice for the parameter DISPLAY MODE. It specifies that the message does not override the display of values, but is included in the Display Sequence in both the Continuous and Sequential Display modes, like any other display or value.

**BLANK MAJOR PERIODS** - Chart Prompts - Chart Configuration - Page 6-5

Parameters that specifies the number of major time lines to print between sets of scales, or said another way, the number of major time divisions to leave between sets of major time divisions which include scales. This is used to reduce the clutter on the chart if every time line included a scale line and the scale values. For example, if three trend lines are being recorded on a 24 hour chart, setting BLANK MAJOR LINES to 5 would yield a completed chart with 3 sets of scales (3 time lines, scale lines, and scale values in each set) evenly spaced around the chart with 5 major time lines between each set of scales.

**CALIBRATION** - System Prompts - Section 11

Prompt section where routines for performing various calibrations are located.

**CHANGE ALL ENABLES** - System Prompts - Enables & Passwords - Page 9-1

Prompt which provides ability to change all enable settings at once, rather than one at a time. When YES is selected, the next prompt will be CHANGE ALL TO. See CHANGE ALL TO.

**CHANGE ALL TO** - System Prompts - Enables & Passwords - Page 9-1

Prompt at which the choice changes all enable settings. The choices are DISABLED, ENABLED, and TOGGLE. The TOGGLE choice causes all sections that are enabled to be disabled, and vice versa. This prompt is accessed only by selecting YES for CHANGE ALL ENABLES.

**CHANGE CHART** - Chart Prompts - Page 6-1

Prompt which provides selection of NO or YES - when first viewed, NO is blinking. To change the chart, select YES. Chart will stop and the instrument will display the next prompt. When stopped in this manner, it can only be started by selecting YES at the START NEW CHART prompt.

**CHART CONFIGURATION** - Chart Prompts - Page 6-2

Prompt section containing parameters which configure the chart in a general sense. The parameters include: chart size, speed, time periods, time line colors, etc. The configuration of the trend recording is done in the RECORDERS section under CONFIGURATION.

**CHART Key**

The CHART key is used to enter the Chart Prompts and to advance through the individual chart prompts.

**CHART MESSAGES** - System Prompts - Configuration - Page 4-92

Prompt section containing parameters which configure Chart Messages. A Chart Message consists of a text message, four values, and a time and date stamp. The message is recorded on the chart when triggered by the transition of an actuator. The text is recorded unless it is blank, and the values and time/date stamp are optional, so the message could be one to six “lines”. Missing lines cause the remaining lines to be moved up. The message overwrites the scale data (as opposed to being “ored” with it) in order to insure readability. Trend and time lines are not overwritten or lost.

**Chart Prompts** - Page 6-1

One of three main prompt sections used to provide access to all chart related configuration functions and provide access to change the chart when required.

**CHART ROTATION (Actuator)**

Actuator that is controlled by the selected state for the CHART ROTATION prompt found in the Chart Prompts section. See ROTATE CHART ACTUATR.

**CHART ROTATION (Prompt) - Chart Prompts - Page 6-2**

Parameter that controls the CHART ROTATION actuator. This parameter is like a special Operator Input which is pre-configured, but located in the Chart Prompts, as it causes no action directly, but merely changes the state of the CHART ROTATION actuator. For some applications it may be desirable to control chart rotation with a prompt, so this was included in the Chart Prompts.

**CHART SIZE - Chart Prompts - Chart Configuration - Page 6-2**

Parameter that specifies the chart size: 10, 11, or 12 inches.

**CHART SPEED - Chart Prompts - Page 6-1**

This prompt only appears if ALTERNATE SPEED USED is set to YES. The choices of NORMAL or ALTERNATE control the ALT CHART SPEED actuator, which is typically selected for the ALT SPEED ACTUATOR parameter in the CHART CONFIGURATION section.

**Chart Speed - Chart Prompts - Chart Configuration - Page 6-3**

Configured at the NORMAL SPEED prompt, provides user selectable chart speeds.

**CHART TAG - Chart Prompts - Chart Configuration - Page 6-3**

Parameter used to specify a description or designation that can be printed on the edge of the chart.

**CHART TYPE USED - Chart Prompts - Chart Configuration - Page 6-2**

Parameter that specifies the type of chart being used. The choices are: RINGS ONLY, RINGS AND TIME LINES, and RINGS/LINES/SCALES. RINGS ONLY corresponds to charts that only have preprinted rings, and this is what is typically used, as it takes full advantage of the recorder's ability to annotate the chart. In some cases, customers may prefer preprinted lines to be used for time lines and scale lines, which corresponds to RINGS AND TIME LINES, or preprinted scale values as well, which corresponds to RINGS/LINES/SCALES.

**Choice**

A general term which refers to a parameter that is configured by selecting one of several descriptions that appears in the lower display, rather than a value or number. Choices vary from the simple YES and NO, to one of a list of over 100 actuators.

**COLLECT DATA ACTUATR - Chart Prompts - Chart Configuration - Page 6-13**

Parameter that specifies the actuator that controls whether data is "collected". "Collected" means that it is captured or retained for recording on the chart. If the chart is "rotating", the trend data will be recorded immediately. If the chart is not "rotating" the data will be retained until the chart begins rotating for normal recording. Data can be retained for a limited time, before the oldest data is discarded to make room for the newest data.

**CONFIGURATION - System Prompts - Section 4**

A section of the System Prompts which provides access to INPUTS, PROCESS VARIABLES, RECORDERS, RELAYS, and other sections to configure the various functions of the instrument.

**Configure Chart - See CHART CONFIGURATION****CONNECT THE AVERAGES - System Prompts - Configuration - Recorders - Page 4-46**

The recording method that is the same as AVERAGE VALUES, but prints a line between successive averages to form a continuous trend line.

**CONNECT THE VALUES - System Prompts - Configuration - Recorders - Page 4-46**

The recording method that is the same as INSTANTANEOUS VALUES, but prints a line between successive values to form a continuous trend line.

**CONSTANTS** - System Prompts - Configuration - Page 4-14

Prompt section containing parameters used as fixed values which are typically used for scaling constants in Derived Variables.

**CONTINUOUS (ACTUATION)** - System Prompts - Configuration - Operator Inputs - Page 4-83

A choice for the parameter ACTUATION STYLE which specifies that the actuator associated with an Operator Input will remain in the selected state continuously, rather than momentarily. See MOMENTARY.

**CONTINUOUS (DISPLAY MODE)** - Display Prompts - Page 5-1

A choice for the parameter DISPLAY MODE which specifies that the instrument will continuously display a single step of the Display Sequence, and will not automatically advance. The UP or DOWN keys can be used to step backward or forward through the list or series of displays.

**CONTINUOUS (TOTAL)** - System Prompts - Configuration - Totalizers - Page 4-56

A choice for the parameter TOTALIZER TYPE which specifies that the total counts to 999,999,999 and then rolls-over. The corresponding actuator (TOTAL 1 through TOTAL 4) is true whenever the total is equal to or greater than the TOTALIZER PRESET value. The RESET ACTUATOR resets the total to zero.

**COUNT DOWN PRESET** - System Prompts - Configuration - Totalizers - Page 4-56

A choice for the parameter TOTALIZER TYPE which specifies that the total counts down to zero from a preset value. The corresponding actuator (TOTAL 1 through TOTAL 4) is true whenever the total is equal to zero. The RESET ACTUATOR resets the total to the TOTALIZER PRESET value.

**COUNT TO PRESET** - System Prompts - Configuration - Totalizers - Page 4-56

A choice for the parameter TOTALIZER TYPE which specifies that the total counts to or just above the preset value and stops. The corresponding actuator (TOTAL 1 through TOTAL 4) is true whenever the total is equal to or greater than the TOTALIZER PRESET. The RESET ACTUATOR resets the total to zero.

**CURRENT OUTPUT RANGE** - System Prompts - Configuration - Current Outputs - Page 4-70

Parameter that specifies the range of the current output; 0-20mA or 4-20mA.

**CURRENT OUTPUTS** - System Prompts - Configuration - Page 4-69

Prompt section containing parameters which configure the sources and ranges for the current (4-20mA) type outputs.

**CUSTOM CURVES** - System Prompts - Configuration - Page 4-15

Prompt section containing parameters which specify the characteristics of custom curves. Each of 4 curves can have up to 20 point pairs. The curve is applied by selecting a CUSTOM CURVE choice as a Derived Variable function. The curves can be used to perform non-linear engineering value translations, or perform piece-wise correction to a value.

**CUTOFF TYPE** - System Prompts - Configuration - Inputs -Page 4-10

Parameter that specifies the optional cutoff or lower boundary condition to be established and applied to an IV (Input Value).

**CUTOFF VALUE** - System Prompts - Configuration - Inputs -Page 4-10

Parameter that specifies the value to be used in conjunction with CUTOFF TYPE.

**CYCLIC** - System Prompts - Configuration - Operator Messages - Page 4-88

One of the choices for DISPLAY MODE that specifies that the Operator Messages will appear "cyclically". In Continuous Display Mode, "cyclically" means that the display will alternate between the normal selected value or message display and the highest priority Operator Message. Message priority is in order of message number, with Operator Message 1 being the highest priority. The UP and DOWN keys can be used to change the selected value or message, as they normally would. In Sequential Display Mode, "cyclically" means that the display will sequence through all normal value displays and then all active Operator Messages.

**DAXx ITEM xx** - System Prompts - Configuration - Derived Actuators - Page 4-80

One of a list of choices that is used to configure a Derived Actuator. The list includes actuators and logical operators that are combined to form a logic equation.

**Data collection** - See Trend data collection

**DATE FORMAT** - System Prompts - Configuration - Instrument Settings - Page 4-75

Parameter that specifies the format used to display dates; MM/DD/YY, DD/MM/YY, or DD/MMM/YY.

**DEGREES C/F** - System Prompts - Configuration - Inputs - Page 4-4

Parameter that specifies whether to convert a thermocouple or RTD input to a value corresponding to degrees C or F. This is not the same as UNITS, which is the text displayed for engineering units.

**DERIVED ACTUATORS** - System Prompts - Configuration - Page 4-80

Prompt section to configure Derived Actuators, which are the logical combination of individual actuators. Up to 24 can be configured.

**DERIVED VARIABLES** - System Prompts - Configuration - Page 4-18

Prompt section containing parameters which configure Derived Variables, which are the mathematical result of other variables and constants.

**DISABLED** - System Prompts - Enables & Passwords - Section 9

Choice which causes the corresponding prompt section to be inaccessible by the operator.

**DISP Key**

The DISP (Display) key is used to enter the Display Prompts section and to step through the individual Display Prompts.

**DISPLAY FILTER** - System Prompts - Configuration - Inputs, Process Variable, Derived Variable

Parameter that specifies the filtering to be applied to the value for display purposes only. This filter does not affect the IV, PV, DV, etc. as it is used for alarming, recording or any other purpose. Zero specifies no filtering. A value of 1 to 9999 specifies the number of seconds over which values will be accumulated prior to calculating a new average for display. Note: When Value Filter is used, its value will affect the displayed value. See VALUE FILTER.

**DISPLAY FORMAT** - Display Prompts - Page 5-2

Parameter that specifies the desired display formats; 1 value at a time, 2 values at a time, or 4 process variables at time, with the displayed choices being 1 VAL, 2 VALS, and 4 PVS. Refer to Section 5 of this manual for details.

**DISPLAY FORMAT** - System Prompts - Configuration - Totalizers - Page 4-56

Parameter that specifies the display format for the total; DIGITS - NO COMMAS or DIGITS WITH COMMAS.

**DISPLAY MODE** - Display Prompts - Page 5-1

Parameter that specifies the CONTINUOUS or sequential (SEQUENCE) display mode. See OM DISPLAY MODE for Operator Messages.

**DISPLAY OPTION** - System Prompts - Configuration

Parameter that specifies the display option for the corresponding value or message. The choices are NOT DISPLAYED, IN CONTINUOUS MODE, IN SEQUENTIAL MODE, and IN BOTH MODES.

**Display Prompts** - Section 5

One of the three main prompt sections, accessed by the DISP key, in which all display format parameters and Operator Prompts are located.

**Display Sequence**

The list or series of value and message displays that appears in the Normal Display mode.

**DISPLAY TAG** - System Prompts - Configuration

Parameter used to specify a description or designation that can be displayed with the Input Value, Process Variable, or Derived Variable when they are included in the Display Sequence in the 1 VAL (1 value at a time) Display Mode. The tags do not appear in the other display modes, as there is no space for them.

**DISPLAY UNITS** - System Prompts - Configuration

Parameter that specifies the units for the corresponding value; degrees C, F, or OTHER. If OTHER is selected, the next prompt will allow the user to enter up to six characters to be used or displayed as the engineering units.

**DIVISION** - System Prompts - Configuration - Recorders

Units for ZONE parameters that specify location relative to the CHART DIVISIONS parameter. Divisions means the same as rings. Division 0 is the inner ring.

**DRAG - MIN TO MAX** - System Prompts - Configuration - Recorders - Page 4-46

The recording method that prints a line between the minimum and maximum values of the trended value during the "print interval".

**DV FUNCTION** - System Prompts - Configuration - Derived Variables - Page 4-19

Parameter used to select type of math function to perform derived variable calculations.

**DV INPUT ACTUATOR** - System Prompts - Configuration - Derived Variables - Page 4-23

Parameter that selects an actuator used as an input to a Derived Variable Function that determines what the output from that function will be.

**DV RESET ACTUATOR** - System Prompts - Configuration - Derived Variables - Page 4-24

Parameter that selects an actuator used as an input to a Derived Variable Function that causes the respective reset action, which may vary with each DV function

**ENABLED** - System Prompts - Enables & Passwords - Section 9

Choice which causes the corresponding prompt section to be accessible by the operator.

**ENABLES & PASSWORDS** - System Prompts - Section 9

Prompt section where prompt sections are enabled or disabled and passwords are configured.

**HYSTERESIS** - System Prompts - Configuration - Process Variables - Page 4-37

Parameter used to specify the deadband for an alarm. Deadbands are one sided below the setpoint.

**INPUT** - System Prompts - Configuration - Page 4-1

Parameters found in various sections, used to specify the source of the value to be used by that functional block. For example, IV2 (Input Value 2) may be the INPUT to PV2 (Process Variable 2). That means that PV2 uses, displays, and alarms on the value from IV2, which could be determining the value from a thermocouple sensor.

**INPUT CORRECTION** - System Prompts - Configuration - Inputs - Page 4-11

Parameters used to specify a correction at two selected points, thus providing a slope/intercept correction over the entire input span. The entered values specify the amount of correction at each point, not the desired value.

**INPUT RANGE HIGH** - System Prompts - Configuration - Inputs - Page 4-6

Parameter to specify upper range of the analog input signal when the input is volts or current. Example: 100mV, 5 VOLTS, 20mA

**INPUT RANGE LOW** - System Prompts - Configuration - Inputs - Page 4-5

Parameter to specify lower range of the analog input signal when the input is volts or current. Example: 0mV, 1 VOLTS, 4mA

**INPUTS** - System Prompts - Configuration - Page 4-1

Prompts section that configures how hardware inputs are processed to provide the desired engineering values, decimal position, and units, for the sensor type and range used. Other characteristics are also configured for out-of-range checking, cutoff, input correction, filtering.

**INPUT TYPE/RANGE** - System Prompts - Configuration - Inputs - Page 4-3

Specifies whether the input type is thermocouple, RTD, volts, milliamps, millivolts, pulse, switch, or not used (OFF - NO INPUT).

**INSTANTANEOUS VALUES** - System Prompts - Configuration - Recorders - Page 4-46

The choice for the parameter RECORDING METHOD that prints a single dot corresponding to the instantaneous value of the trended value at the end of the "print interval". This method records a series of dots which may not form a continuous trend line.

**INSTR. ON ACTUATOR** - System Prompts - Configuration - Instrument Settings - Page 4-73

Parameter used to specify an actuator which controls whether the instrument's outputs are active. When inactive, all outputs (relays, mA, LEDs) are reset, totalizing is stopped and the instrument displays the Instrument Tag and "INSTRUMENT OFF". The instrument continues to scan and process inputs, derived variables, process variables, alarms (but with no relay outputs), times and dates, actuators, derived variables, records and collects data.

**INSTRUMENT SETTINGS** - System Prompts - Configuration - Page 4-72

Prompts section that configures various instrument wide parameters, such as instrument tag, time and date formats, the current date and time, and some special actuator selections.

**INSTRUMENT TAG** - System Prompts - Configuration - Instrument Settings - Page 4-72

Parameter used to specify a description or designation that can be displayed with the current time and date in the Display Sequence.

**LED ACTUATOR** - System Prompts - Configuration - LEDs - Page 4-65

Parameter that selects an actuator, which, when true, causes the specified LED, 1-8, to be lit.

**LEDS** - System Prompts - Configuration - Page 4-64

Prompts section that configures actuators for the LEDs.

**LOW FLOW CUTOFF** - System Prompts - Configuration - Totalizers - Page 4-57

Parameter that specifies the value below which the flow will not be added to the total. If the flow rate is negative, the flow will be subtracted if the value is more negative than the magnitude of the LOW FLOW CUTOFF value specified. If negative flow totalization (subtraction) is not desired, the negative flow rate must be cutoff at the input using CUTOFF TYPE and CUTOFF VALUE. For example, if LOW FLOW CUTOFF is 100 GAL/HR, positive flow of 0 to 99 GAL/HR will not be totalized, but negative flow of -101 or more negative would be totalized (subtracted).

**Major time lines**

Major time lines are printed as a series of dots, with noticeable spacing, and extend from the inner chart ring to the outer chart ring. The number of major time lines printed on the chart is determined by the MAJOR TIME PERIODS parameter in the Chart Configuration. The color of the major time lines is programmable.

**MAJOR TIME PERIODS** - Chart Prompts - Chart Configuration - Page 6-4

Parameter that specifies the number of periods or sections the chart shall be divided into. This also corresponds to the number of "major time lines" printed, and indirectly, the time between them.

**MATCH/SELECT** - Chart Prompts - Chart Configuration - Page 6-8

Parameters which specify whether time lines, times, and dates and chart tags should be in the same color as the scale just printed, or always be a fixed color.

### **MATCH SCALE COLOR** - Chart Prompts - Chart Configuration - Page 6-8

A choice for MATCH/SELECT prompts which specifies that the corresponding time line, time, or date and chart tag should be in the same color as the scale, as the chart is being printed.

### **Minor time lines**

Minor time lines are printed as a series of dots, with spacing greater than major time lines and extend from the inner chart ring to the outer chart ring. Minor time lines are printed between major time lines, and the number of minor time lines is one less than the number of MINOR TIME PERIODS specified in Chart Configuration.

### **MINOR TIME PERIODS** - Chart Prompts - Chart Configuration - Page 6-8

Parameter that specifies the number of periods or sections each major time period shall be divided into. This also corresponds to one less than the number of "minor time lines" printed, and indirectly, the time between them.

### **MOMENTARY** - System Prompts - Configuration - Operator Inputs - Page 4-83

One of two choices for ACTUATION STYLE where the state must be active only momentarily, rather than continuously. For example, for an Operator Input used to reset a totalizer: MOMENTARY would cause the total to be reset when the ON/YES/1 choice was selected, but it would then begin to totalize again, as the actuator would only reset it momentarily. CONTINUOUS, the other choice, would cause the total to be reset when the ON/YES/1 choice was selected, but it would remain reset until the OFF/NO/0 choice was selected, as the actuator would be keeping it reset continuously.

### **NONE - JUST CONTINUE** - Chart Prompts - Chart Configuration - Page 6-11

The choice for the parameter ACTION ON NEW CHART that does not print a range list or set of scales before it begins recording trend data.

### **NONE/OFF**

One of the list of actuators which is effectively no selection. This is the default or initial configuration for most actuator parameters. It evaluates to false or 0.

### **Normal Display mode**

The state the unit is in, relative to what's in the display, when it is not in the Display Prompts, Chart Prompts, or System Prompts. In this state, values and/or messages are being displayed, rather than prompts.

### **OFF STATE TEXT** - System Prompts - Configuration - Operator Inputs - Page 4-83

Parameter that specifies the text that will be displayed at the left of the lower display when the Operator Input is shown in the Display Prompts. When this choice is selected, the corresponding actuator (OP INP 1 through OP INP 12) will be set to false. Typical text may be OFF, NO, STOP, STOPPED, HOLD, etc.

### **OMxx ACTUATOR** - System Prompts - Configuration - Operator Messages - Page 4-87

Parameter that selects an actuator, which, when true, causes the specified Operator Message (1 through 12), to be displayed per the Operator Message Display Mode setting.

### **OMxx DISPLAY MODE** - System Prompts - Configuration - Operator Messages - Page 4-88

Parameter that specifies the method of displaying the operator message when it is actuated. The choices are PREEMPT, PREEMPT TO CYCLIC, PREEMPT TO OFF, CYCLIC, and BACKGROUND.

### **ON STATE TEXT** - System Prompts - Configuration - Operator Inputs - Page 4-83

Parameter that specifies the text that will be displayed at the right of the lower display when the Operator Input is shown in the Display Prompts. When this choice is selected, the corresponding actuator (OP INP 1 through OP INP 12) will be set to true. Typical text may be ON, YES, RUN, etc.

### **ON/CONTINUOUS**

One of the list of actuators which is effectively no selection, but this choice evaluates to true, active or 1. This is the default or initial configuration for a few actuator parameters, such as INSTR. ON ACTUATOR and ALARMS ON ACTUATOR.

**OPERATOR INPUTS** - System Prompts - Configuration - Page 4-84

Prompts section that configures the text for the message and states and actuation type associated with each Operator Input. The corresponding actuators can then be changed in the Display Prompts.

**OPERATOR MESSAGES** - System Prompts - Configuration - Page 4-88

Prompts section that configures the two lines of text and DISPLAY MODE for each Operator Message. They are displayed only if their actuator is active and appear during Normal Display as specified by the DISPLAY MODE parameter. They can provide a variety of functions from preemptive critical alarm messages to continuous display of reference information such as what each LED represents.

**Out-of range** - See Sensor break

**PEN/COLOR** - System Prompts - Configuration - Recorders - Page 4-45

Parameter used to specify the pen or color to be used.

**POWER UP STATE** - System Prompts - Configuration - Operator Inputs - Page 4-84

Parameter that specifies what the state of the actuator should be if power to the instrument is removed and reapplied. The choices are: OFF, ON, and SAME. For most applications SAME would be the choice, so the actuator doesn't change over a power interruption.

**PREEMPT** - System Prompts - Configuration - Operator Messages - Page 4-88

One of the choices for DISPLAY MODE which specifies that the message continuously overrides the display of values.

**PREEMPT TO CYCLIC** - System Prompts - Configuration - Operator Messages - Page 4-88

One of the choices for DISPLAY MODE which specifies that the message overrides the display of values until any key is pressed, after which the message will appear "cyclically".

**PREEMPT TO OFF** - System Prompts - Configuration - Operator Messages - Page 4-88

One of the choices for DISPLAY MODE which specifies that the message overrides the display of values until any key is pressed, after which it will not appear until the actuator goes inactive then active again.

**PRELOAD** - System Prompts - Configuration - Totalizers - Page 4-56

One of the choices for TOTALIZER TYPE which specifies that the total counts to 999,999,999 and then rolls over to zero. The corresponding preset actuator is true whenever the total is equal to or greater than the TOTALIZER PRESET value. The RESET ACTUATOR resets the total to the TOTALIZER PRESET value.

**Print interval**

The time between each print cycle, when the pen actuator/cartridge assembly passes over the chart to record trend and other data. The print interval is equal to the value of the chart rotation speed (expressed in hours) expressed in seconds. For example, with a chart speed of 12 hours, the print interval is 12 seconds.

**PRINT RANGE LIST** - Chart Prompts - Chart Configuration - Page 6-11

The choice for the parameter ACTION ON NEW CHART that prints a list of the scale range, units, and recorder tag for each "Recorder" configured. If the Recorder is using two zones or does not use 100% of the printable chart span, the designation NL (for Non-Linear) will be included.

**PRINT SCALES** - Chart Prompts - Chart Configuration - Page 6-11

The choice for the parameter ACTION ON NEW CHART that prints a set of scales for each Recorder configured.

**PROCESS VARIABLES** - System Prompts - Configuration - Page 4-32

Prompts section that configures up to four Process Variables, which can be used for alarming or to take advantage of the 4 PVS Display Format.



## **Prompt**

A message that is displayed in the upper line, while a prompt section name or parameter (value, choice, or text) is displayed in the lower line. During normal operation, the instrument is either displaying a value(s), a message, or a prompt.

## **Prompt section**

A general term for a group of prompts, such as Display Prompts, Configuration, or Inputs.

### **PULSE EVERY** - System Prompts - Configuration - Totalizers - Page 4-60

Parameter used to specify the number of incremental units between each output pulse. See PULSED OUTPUT.

### **PULSED OUTPUT** (Relays) - System Prompts - Configuration - Relays - Page 4-66

One of the choices for RELAY x USAGE which specifies that the relay will be energized momentarily (about 60 milliseconds), typically used in conjunction with a totalizer pulsed output.

### **PULSED OUTPUT** (Totals) - System Prompts - Configuration - Totalizers - Page 4-60

Parameter used to specify whether a pulsed output is configured, which generates a “contact closure” each time the total reaches a multiple of the PULSE EVERY value.

### **PULSES** - System Prompts - Configuration - Totalizers - Page 4-54

One total time base, making the totalizer a transition counter, counting the number of times the value makes a transition from zero.

### **RANGE LIMIT HIGH/LOW** - System Prompts - Configuration - Inputs - Page 4-9

Parameters that specify the normal engineering unit conversion range on inputs other than TC and RTD types and provide values for the “out-of-range” testing. The RANGE LIMIT HIGH (LOW) value corresponds to the engineering unit value when the analog input is at the respective INPUT RANGE HIGH (LOW) value. If the resultant IV (Input Value) is 5% above the high value or below the low value, the unit will drive the corresponding IV to +99999 or -99999, depending upon whether UPSCALE or DOWNSCALE was selected for SENSOR BREAK. The input value will also be “flagged” as being in error. If the 5% allowed is insufficient for a particular application, the band can be widened by widening the INPUT RANGE and RANGE LIMIT values. RANGE LIMIT HIGH/LOW are not needed for the conversion of TC and RTD input types, but are included for the “out-of-range” testing. When the INPUT TYPE is changed to TC or RTD, or when the TC TYPE or RTD TYPE is changed, the high and low values will be set to the limits of the respective input, after which they may be modified.

### **Rate alarm hysteresis** - System Prompts - Configuration - Process Variables - Page 4-37

When the ALARM TYPE selected is RATE RAISING or FALLING, hysteresis applies to the rate of change. For example, for an alarm setpoint of 10 degrees C/MIN, HYSTERESIS of 1 degree C/MIN, the unit will alarm at 10 degrees C/MIN, and reset the alarm at 9 degrees C/MIN (RATE RISING), and alarm at 10 degrees C/MIN, and reset the alarm at 11 degrees C/MIN (RATE FALLING)..

## **RECORDER**

In this instrument, RECORDER applies to an entity that provides the trend recording function on one of the four pens. Each RECORDER is not inherently associated with any particular input, process variable, pen or color, but rather is fully configurable to work with any of these.

### **RECORDERS** - System Prompts - Configuration - Page 4-43

Prompts section that configures recording method, scales, zones, colors, etc., for each RECORDER.

### **RECORDING METHOD** - System Prompts - Configuration - Recorders - Page 4-46

Parameter specifying one of five methods of trend recording: INSTANTANEOUS VALUES, CONNECT THE VALUES, DRAG - MIN TO MAX, AVERAGE VALUES, and CONNECT THE AVERAGES.

### **RELAY ACTUATOR** - System Prompts - Configuration - Relays - Page 4-67

Parameter that selects an actuator, which, when true, causes the specified relay, 1-8, to be energized.

**RELAYS** - System Prompts - Configuration - Page 4-66

Prompts section that configures actuators and other parameters associated with relay and/or solid state relay driver outputs.

**RELAY x USAGE** - System Prompts - Configuration - Relays - Page 4-66

Parameter that specifies the type of output the relay is to provide, or how it is to be used: STATE OR ON-OFF, TIME PROPORTIONING, or PULSED OUTPUT.

**RINGS AND TIME LINES** - See CHART TYPE USED

**RINGS/LINES/SCALES** - See CHART TYPE USED

**RINGS ONLY** - Chart Prompts - Chart Configuration - Page 6-2

A choice for the parameter CHART TYPE which specifies that the charts only has preprinted rings. This is what is typically used, as it takes full advantage of the recorder's ability to annotate the chart, by adding time lines, scale lines, and scale values.

**ROTATE CHART ACTUATR** - Chart Prompts - Chart Configuration - Page 6-12

Parameter which specifies an actuator, which, when true, causes the chart to "rotate" for normal trending. When YES is selected for START NEW CHART, the chart will be initialized per ACTION ON NEW CHART, and then the chart is ready for trending. If the chart is not "rotating", trend data recording is suspended, but "trend data collection" may continue. If it were collected, when the chart began to "rotate", the collected data would be recorded first, then the current real time data.

**RTD TYPE** - System Prompts - Configuration - Inputs - Page 4-4

Parameter that specifies the type of RTD: PT 100 ohm .00385 DIN, .00392 USA, .00392 SAMA, or NI 100 ohm.

**SAMPLE PERIOD** - System Prompts - Configuration - Process Variables - Page 4-37

Parameter that specifies the time period between samples for calculation of the rate of change of the Process Variable for Rate Alarms. If the time between samples is too short, one second for example, a slight but quick change may erroneously trigger the alarm. Conversely, too long of a period may delay the recognition of an alarm condition. The period is dependent upon the application.

**SCALE INTERVAL** - System Prompts - Configuration - Recorders - Page 4-49

Parameters that specifies the number of divisions or rings between printed scale values. The values printed are calculated by the instrument. If the SCALE INTERVAL parameter is zero, no scale values are printed, but the RECORDER TAG will be printed. If the SCALE INTERVAL parameter value equals the number of divisions in the zone, scale values will be printed at each end only.

**Scale lines**

Scale lines are printed as a series of dots, closely spaced to form a solid line, and are printed only in the area of the chart (zone or portion of chart span) used for the respective trend line. The scale lines are printed on top of major time lines. The number of scale lines printed on the chart is determined by the MAJOR TIME PERIODS parameter, the number of BLANK MAJOR TIME PERIODS, and the number of trend lines being recorded. The color of the scale line is the same as the respective trend line.

**Scale values**

The set of values printed next to the scale line which identify the engineering values corresponding to the respective rings on the chart, usually evenly spaced at multiples of 10 divisions or rings.

**SELECT A COLOR** - Chart Prompts - Chart Configuration - Page 6-8

A choice for MATCH/SELECT prompts which specifies that the corresponding time line, time, or date and chart tag should always be printed in a fixed color. The color is selected at the next prompt.

## **Sensor break**

While there are sensor break jumpers, JU1 and JU4, sensor break and out-of-range conditions are actually determined and handled by the software. When either occurs, the software will drive the input value to +99999 or -99999 based upon whether SENSOR BREAK is software configured for UPSCALE or DOWN SCALE. Any outputs will react accordingly. Out-of-range is defined as being more than 5% out of the span established by RANGE LIMIT LOW and RANGE LIMIT HIGH.

For 5 or 10 volt and current inputs, the analog signal goes to zero when there is a sensor break, due to voltage divider or shunt resistors. For sensor break detection to work on these input types, the INPUT RANGE LOW (analog signal low) and/or RANGE LIMIT LOW (engineering units low) parameters must be set high enough such that at zero volts/mA, the resultant value will be at least 5% below the span established by RANGE LIMIT LOW and RANGE LIMIT HIGH.

## **SIMULATED VARIABLES** - System Prompts - Configuration - Page 4-98

Prompts section that configures up to four SVs (Simulated Variables) that can be used to simulate an input, primarily for demonstration purposes. The functions available are: sin wave, square wave, spikes, or sawtooth.

## **SPAN 1 HIGH** - System Prompts - Configuration - Recorders - Page 4-48

Parameter that specifies the trend value corresponding to the "top" of zone 1. This parameter also specifies the "bottom" of zone 2, if two zones are used.

## **SPAN 1 LOW** - System Prompts - Configuration - Recorders - Page 4-48e

Parameter that specifies the trend value corresponding to the "bottom" of zone 1.

## **SPAN 2 HIGH** - System Prompts - Configuration - Recorders - Page 4-50

Parameter that specifies the trend value corresponding to the "top" of zone 2.

## **START NEW CHART** - Chart Prompts - Page 6-1

When YES is selected, the unit will initialize itself for a new chart and automatically return to the Normal Display mode. This prompt appears only after the chart has been stopped by selecting YES at the CHANGE CHART prompt.

## **STATE OR ON-OFF** - System Prompts - Configuration - Relays - Page 4-66

One of the choices for RELAY x USAGE which specifies that the relay output will be energized whenever the selected actuator is active. This is used for most applications.

## **STOP AFTER 1 REV** - Chart Prompts - Chart Configuration - Page 6-11

Parameter which controls whether the chart stops recording after one revolution (360 degrees of rotation). If YES is selected, trend data would typically continue to be collected and would be recorded after a new chart is installed.

## **SWITCH CONTACT** - System Prompts - Configuration - Inputs - Page 4-3

One of the choices for INPUT TYPE which specifies that it is used as a contact-closure sensing the input.

## **Tx HOLD ACTUATOR** - System Prompts - Configuration - Totalizers - Page 4-59

Parameter that selects an actuator which can suspend totalization when active.

## **Tx RESET ACTUATOR** - System Prompts - Configuration - Totalizers - Page 4-58

Parameter that selects an actuator that will reset the total when active.

## **Tag**

A general term which refers to a description or designation that is displayed or recorded. There are tags for the instrument, chart, and each input, process variable, recorder, etc. Tags are text parameters.

## **TC TYPE** - System Prompts - Configuration - Inputs - Page 4-3

Parameter which specifies the thermocouple type to be used.

**TEST** - System Prompts - Section 10

Prompt section which provides access to various test routines.

**Text**

A general term which refers to a parameter that is a series of characters, such as a display tag, units, or contents of a configurable message.

**TIME BASE** - System Prompts - Configuration - Totalizers - Page 4-54

Parameter that specifies the time base of the flow rate, so the instrument can calculate the total. The choices are units: PER SEC, PER MIN, PER HOUR, PER DAY, and PULSES.

**Time between print cycles** - see Print interval

**TIME FORMAT** - System Prompts - Configuration - Instrument Settings - Page 4-75

Parameter that specifies the format for displaying time; AM/PM or 24 HOUR.

**TIME FORMAT** - System Prompts - Configuration - Timers - Page 4-62

Parameter that specifies the time format for timers; SECONDS, MINUTES:SECONDS, or HOURS:MINUTES:SECONDS.

**TIMER TYPE** - System Prompts - Configuration - Timers - Page 4-62

Parameter that specifies the type of timer; OFF, COUNT UP, or COUNT DOWN.

**TIMERS** - System Prompts - Configuration - Page 4-61

Prompts section that configures periodic actuators that can control instrument activities. Timers can count up to a terminal value or count down from a value to zero. At the end of the timing function, their respective actuators are set true. Each timer has a reset actuator, which when true, causes the timer value to be set to its initial value.

**TMx RESET ACTUATOR** - System Prompts - Configuration - Timers - Page 4-63

Parameter that selects an actuator, which when true, causes the specified timer value to be set to its initial value (zero or the Timer Period value), depending on whether the Timer Type is Count Up or Count Down.

**TOTAL IS FLOW** - System Prompts - Configuration - Totalizers - Page 4-55

Parameter used to specify what scaling factor the flow value should be multiplied by in calculating the total value. If the choice TIMES 1,000,000 is selected, and the flow was 0.3 MGD (Million Gallons per Day), at the end of a day the total would be 0.3 million gallons, but the totalizer would display a value of 300,000 (0.3 times 1,000,000) and the total would correspond to gallons, maybe displayed as GAL.

**TOTALIZER GENERAL FORMULA**

The general formula for the totals, calculated each second is:

$$\text{TOTAL} = \text{TOTAL} + (\text{VALUE} / \text{TTB}) * \text{FACTOR}$$

Where: VALUE is the once a second value or one second average for the selected input source.

TTB is	1	for TOTAL TIME BASE - PER SECOND
	60	for TOTAL TIME BASE - PER MINUTE
	3600	for TOTAL TIME BASE - PER HOUR
	86400	for TOTAL TIME BASE - PER DAY

FACTOR is the selected factor (.0001 to 100000)

**TOTALIZER TYPE** - System Prompts - Configuration - Totalizers - Page 4-56

Parameter that specifies one of four types of totalizing; CONTINUOUS, PRE-LOAD, COUNT TO PRESET, or COUNT DOWN PRESET.

**TO ZERO BELOW VALUE** - System Prompts - Configuration - Inputs - Page 4-10

One of the choices for CUTOFF TYPE which specifies that the resultant IV (Input Value) is set to zero whenever the input value is less than the CUTOFF VALUE. Consequently negative values are set to zero. The CUTOFF VALUE must be positive.

**TO ZERO NEAR ZERO** - System Prompts - Configuration - Inputs - Page 4-10

One of the choices for One method of input cutoff type, when selected, sets the input value to zero whenever the absolute value is less than the specified value, thus allowing negative values, but zeroing small positive or negative values. The CUTOFF VALUE must be positive.

**TREND DATA COLLECT** (Actuator)

Actuator that is controlled by the selected state at the TREND DATA COLLECT prompt found in the Chart Prompts section.

**TREND DATA COLLECT** (Prompt) - Chart Prompts - Page 6-14

Parameter that controls the TREND DATA COLLECT actuator. This parameter is like a special Operator Input which is pre-configured, but located in the Chart Prompts, as it causes no action directly, but merely changes the state of the TREND DATA COLLECT actuator. For some applications it may be desirable to control trend data collection with a prompt, so this was included in the Chart Prompts.

**Trend data collection**

A general term which refers to the instruments ability to collect trend data to be recorded when the chart is rotating for normal recording (which excludes initializing a new chart). If data collection remains on while the chart is not rotating or is being initialized, when rotation resumes, collected data will be recorded prior to recording current real time data. The instrument can collect up to 360 trend values. If an instrument is configured with 4 Recorders and a 24 hour chart speed, it could collect data for 36 minutes before it began to loose the oldest data. [(360 values / 4 Recorders) = 90 print cycles, times 24 seconds per print cycle (print interval), results in 2160 seconds or 36 minutes]

**Value**

A general term referring to a number or a parameter that is a number.

**VALUE FILTER** - System Prompts - Configuration

Parameter found in various sections that specifies the filtering to be applied to the value for all purposes. This filter affects the IV, PV, DV, etc. as it is used for alarming, recording or any other purpose. Zero specifies no filtering. A value of 1 to 9999 specifies the number of seconds over which values will be accumulated prior to calculating a new average for display. See DISPLAY FILTER.

**V/MA CONV** - System Prompts - Configuration - Inputs - Page 4-7

Parameter that specifies the type of conversion for the input. The choices are: LINEAR, SQRT, and EXP, for linear, square root, and exponential. If EXP is selected, the next parameter will be the exponential value.

**WHEN DISPLAYED** - System Prompts - Configuration - Operator Inputs - Page 4-84

Parameter that specifies when an Operator Input is displayed, ALWAYS or WHEN ENABLED.

If the WHEN ENABLED choice is selected, that Operator Input is not shown when OPERATOR INPUTS is DISABLED in ENABLES & PASSWORDS.

**Zone**

The portion of the chart over which a trend line is to be recorded. The zone may be less than the maximum area available for recording. Trends can be recorded in two adjacent zones to allow for higher resolution on one end of the recorded span. Zones are established with respect to the number of rings or divisions on the chart, typically 70, 100, or 120 rings or divisions. Division 0 is the inner ring.

**ZONE 1 HIGH** - System Prompts - Configuration - Recorders - Page 4-47

Parameter that specifies the DIVISION or ring corresponding to the "top" end of the zone. This parameter also specifies the "bottom" of zone 2, if two zones are used.

**ZONE 1 LOW** - System Prompts - Configuration - Recorders - Page 4-47

Parameter that specifies the DIVISION or ring corresponding to the “bottom” end of the zone.

For reverse ranges (lower engineering value at the outer portion), either the two ZONE parameters or the two SPAN parameters can be reversed.

**ZONE 2 HIGH** - System Prompts - Configuration - Recorders - Page 4-49

Parameter that specifies the DIVISION or ring corresponding to the “top” end of the second zone. Setting it to zero specifies that only one zone is being used. ZONE 1 HIGH specifies the “bottom” of zone 2 if two zones are used.

---

# Appendix D - Examples

## EXAMPLE 1

### Application:

Palmer-Bowlus Flume Height/Flow

Given: Transmitter output linear in distance (4mA=0.0", 20mA=2.85")

### Configuration:

Inputs: As required

Custom Curves: See below

Derived Variables: See below

Process Variables (if alarming required): As required

Recorders: See below

Totalizers (if Totals required): As required

Instrument Settings: As required

LEDs/Relays: As required

Chart: As required

### Custom Curves:

Custom Curves Number	1
CC1 Decimal Position of Input	2
CC1 Decimal Position of Output	2
CC1 Number of Points	20
CC1 Point Pair 1	0.00 --> 0.00
CC1 Point Pair 2	0.15 --> 0.30
CC1 Point Pair 3	0.30 --> 1.00
CC1 Point Pair 20	2.85 --> 50.20

### Derived Variables:

DV Number	1
DV1 Display Tag	GPM
DV1 Function	Custom Curve 1
DV1 Input	IV1 (Input configured)
DV1 Display Units	Other
DV1 Units Description	CPM
DV1 Decimal Position	2

### Recorders:

Recorder Number	1
R1 Recorder Tag	Flow
R1 Recording Method	Drag - Min to Max
R1 Value to Record	DV1
R1 Decimal Position	2
R1 Chart Divisions	100
R1 Zone 1 Low	Division 0
R1 Zone 1 High	Division 100
R1 Span 1 Low	0.00 GPM
R1 Span 1 High	50.20 GPM
R1 Scale Interval	10 Divisions

## **EXAMPLE 2**

### Application:

User would like to combine logically 3 alarms to create an AND situation.

### Configuration:

#### Derived Actuators:

Derived Actuator	1
DA1 Item 1	A11 (Alarm 1 Process Value 1 Active)
DA1 Item 2	AND
DA1 Item 3	A12 (Alarm 2 Process Value 1 Active)
DA1 Item 4	AND
DA1 Item 5	A13 (Alarm 3 Process Value 1 Active)
DA1 Item 6	END

If Alarm 1 on Process Value 1 is Active AND Alarm 2 on Process Value 1 is Active AND Alarm 3 on Process Value 1 is Active, THEN DA1 (Derived Actuator 1) will be TRUE.

## **EXAMPLE 3**

### Operator Inputs

Operator Inputs are prompts the end user may program into the instrument that allow these prompts to turn on or off actuators that control some other function within the instrument.

### Application:

A user would like to turn an exhaust fan on or off as required by an operator via the keypad.

### Configuration:

#### Operator Inputs:

Operator Input	1
OI1 Prompt Text	EXHAUST FAN
OI1 Off/No/0 Choice	FAN OFF
OI1 On/Yes/1 Choice	FAN ON
OI1 Actuation Style	CONTINUOUS
OI1 Power Up State	SAME
OI1 When Displayed	ALWAYS

To complete configuring, configure Relay X Actuator OP INP 1 and connect Relay X to the exhaust fan.

### Operation:

From the Normal Display, depress the DISP key until EXHAUST FAN appears in the top display line and FAN OFF FAN ON appears in the bottom display line, one of these should be blinking indicating the current state of the fan. Depress the key located directly below the choice that is not blinking (F1 FAN OFF & F5 FAN ON). IF FAN ON was selected, a relay should energize corresponding to the relay assigned above. If FAN OFF was selected, a relay should de-energize corresponding to the relay assigned above.



#### **EXAMPLE 4**

##### Operator Messages

Operator Messages are user defined messages to advise, or provide information, via the display, that selected actuators are active. The messages are displayed as specified by the Operator Message Display Mode parameter setting.

##### Application:

A user would like a visual indication whenever the total exceeds the preset along with instructions for an operator.

##### Configuration:

##### Operator Message:

Operator Message	1
OM1 Actuator	PRESET 1
OM1 Line 1 Text	TOTAL EXCEED PRESET
OM1 Line 2 Text	PHONE 908 6666
OM1 DISPLAY Mode*	PREEMPT TO OFF

\*PREEMPT TO OFF - Specifies that the message overrides the display of values until any key is pressed, after which it will not appear until the actuator goes inactive then active again.

#### **EXAMPLE 5**

##### Chart Messages

Chart Messages allow user defined text, up to 4 values, and a time/date stamp to be recorded on the chart, triggered on the transition of an actuator, not its state. The message can be one to six lines with missing lines causing the remaining line to be moved up. The message is recorded on the six outermost "lines" within the trend area. Trend and time lines will not be overwritten or lost.

Since it may take considerable time for the instrument to record a message, three messages will be queued with a fourth queue providing a QUEUE OVERFLOW message. All messages actuated while the queue is full are lost.

##### Application:

A user would like to print a message indicating that Alarm 1 on Process Value 2 has tripped.

##### Configuration:

##### Chart Message:

Chart Message	2
CM2 Actuator	A21 (Alarm 1 Process Value 2)
CM2 Message Text	ALARM 1 PRESSURE HI
CM2 Value 1	IV2 (Input Value for Pressure)
CM2 Value 2	PV2 (Process Value for Alarm)
CM2 Time/Date Stamp	YES

##### Operation:

During Normal Operation, if the pressure exceeds the alarm setpoint, the alarm (A21) will go on and at the same time the actuator, A21, will trigger the chart message, ALARM 1 PRESSURE HI, and print the value of IV2, the actual pressure, and PV2, the process value used to trigger the alarm.

## **EXAMPLE 6**

### Latching Alarm

#### Configuration:

##### Process Variables:

Process Variable	1
PV1 Display Tag	users choice
PV1 Input	IV1
A11 Alarm Type	Process - High
A11 Hysteresis	3

##### LEDs:

LED Number	8
LED 8 Actuator	DA1

##### Relays:

Relay Number	4
Relay 4 Usage	State or On-Off
Relay 4 Actuator	DA1

##### Derived Actuators:

Derived Actuator	1
DA1 Item 1	Not
DA1 Item 2	Reset
DA1 Item 3	And
DA1 Item 4	DA1
DA1 Item 5	Or
DA1 Item 6	A11
DA1 Item 7	End

Derived Actuator 1 will be true when A11 is true OR when DA 1 is true AND the Reset Key is not true. To cause Derived Actuator 1 to be false, press the Reset key, providing the process has gone below the alarm set point.

Note: The LED 8 and Relay 4 will remain latched until the Reset Key is pressed although the display will no longer display the "H" or the "g" (global indicator).

## **EXAMPLE 7**

Latching High Alarm - Latched Open

### Configuration:

#### Process Variables:

Process Variable	users choice
PV1 Display Tag	users choice
PV1 Input	users choice
A11 Alarm Type	Process - High

#### LEDs

LED Number	users choice
LED # Actuator	A11

#### Relay

Relay Number	users choice
Relay # Usage	State or On/Off
Relay # Actuator	DA2

#### Derived Actuators

Derived Actuator	1
DA1 Item 1	NOT
DA1 Item 2	RESET
DA1 Item 3	AND
DA1 Item 4	DA1
DA1 Item 5	OR
DA1 Item 6	A11
DA1 Item 7	END

Derived Actuator	2
DA2 Item 1	NOT
DA2 Item 2	DA1
DA2 Item 3	END

## Appendix E - Accuracy Tables

	See Note:	1	2	3	4	5	6
INPUT TYPE	RANGE	REF ACC'Y	LIN. ACC'Y	FACTORY CAL	REF+LIN +CAL	DEVIATION ACC'Y	RESOL
	°C	°C	°C	°C	°C	°C	°C/bit
J T/C	0/1200	0.43	0.20	0.32	0.95	0.12	0.066
WIDE	-200/0	0.63	0.08	0.56	1.28	0.02	0.097
J T/C	0/400	0.11	0.05	0.33	0.50	0.04	0.017
NARROW	-200/0	0.16	0.08	0.56	0.80	0.02	0.024
K T/C	0/1370	0.62	0.26	0.40	1.28	0.14	0.095
WIDE	-250/0	1.05	0.30	0.78	2.13	0.03	0.159
K T/C	0/500	0.15	0.08	0.39	0.62	0.05	0.023
NARROW	-250/0	0.26	0.30	0.78	1.35	0.03	0.040
E T/C	0/1000	0.33	0.19	0.28	0.80	0.10	0.050
WIDE	-250/0	0.66	0.42	0.62	1.71	0.03	0.101
E T/C	0/300	0.09	0.19	0.29	0.57	0.03	0.014
NARROW	-250/0	0.17	0.42	0.62	1.21	0.03	0.025
N T/C	0/1300	0.68	0.21	0.42	1.32	0.13	0.104
WIDE	-250/0	1.44	0.60	0.93	2.97	0.03	0.220
N T/C	0/600	0.18	0.11	0.44	0.73	0.06	0.028
NARROW	-200/0	0.31	0.20	0.81	1.32	0.02	0.048
	-250/-200	0.93	0.60	2.15	3.68	0.01	0.142
<b>TO ACHIEVE STATED RESULTS, THE FOLLOWING THERMOCOUPLES MUST BE USED WITH THE TC NARROW INPUT TYPE</b>							
G T/C	1800/2300	1.59	0.54	0.79	2.92	0.05	0.243
	800/1800	1.23	0.43	0.64	2.30	0.10	0.188
	500/800	1.38	0.25	0.70	2.33	0.03	0.210
	300/500	1.79	0.25	0.87	2.91	0.02	0.274
	0/300	3.65	0.58	1.61	5.84	0.03	0.557
C T/C	1800/2300	2.14	0.54	1.01	3.68	0.05	0.326
	1200/1800	1.62	0.43	0.80	2.85	0.06	0.247
	300/1200	1.33	0.28	0.68	2.29	0.09	0.202
	0/300	1.54	0.12	0.77	2.43	0.03	0.235
D T/C	1800/2300	1.88	0.38	0.90	3.26	0.05	0.287
	300/1800	1.32	0.40	0.68	2.40	0.15	0.201
	0/300	1.75	0.26	0.85	2.86	0.03	0.267
NNM	450/1370	0.44	0.33	0.33	1.10	0.09	0.067
	0/450	0.56	0.13	0.37	1.06	0.05	0.085
PLII	1000/1400	0.72	0.28	0.44	1.44	0.04	0.110
	500/1000	0.59	0.20	0.38	1.17	0.05	0.089
	0/500	0.62	0.10	0.40	1.12	0.05	0.095

**THE FOLLOWING THERMOCOUPLES ARE AVAILABLE AS NARROW ONLY**

	See Note:	01	2	3	4	5	6
INPUT TYPE	RANGE	REF. ACC'Y	LIN. ACC'Y	FACTORY CAL	REF+LIN +CAL	DEVIATION ACC'Y	RESOL
	°C	°C	°C	°C	°C	°C	°C/bit
T T/C	0/400	0.12	0.09	0.34	0.55	0.04	0.018
	-220/0	0.23	0.19	0.70	1.12	0.02	0.036
	-250/-220	0.73	0.36	1.90	2.98	0.00	0.111
R T/C	800/1700	0.43	0.19	0.83	1.45	0.09	0.065
	200/800	0.58	0.25	1.08	1.90	0.06	0.088
S T/C	250/1750	0.56	0.25	1.05	1.87	0.15	0.086
B T/C	200/1800	0.74	0.31	1.34	2.39	0.16	0.113

	See Note:	1	2	3	4	5	6
INPUT TYPE	RANGE	REF. ACC'Y	LIN. ACC'Y	FACTORY CAL	REF+LIN +CAL	DEVIATION ACC'Y	RESOL
	°C	°C	°C	°C	°C	°C/°C	°C/bit
385	-160/480	0.16	0.03	0.13	0.33	0.06	0.025
RTD	-200/-160	0.14	0.20	0.12	0.46	0.00	0.022
392 RTD	-100/450	0.16	0.03	0.13	0.32	0.05	0.025
392 SAMA	-200/560	0.29	0.13	0.24	0.66	0.06	0.044
100 ohm Nickel	-40/200	0.09	0.05	0.07	0.21	0.02	0.013

	See Note:	1	3	4	5	6
LINEAR RANGES	SPAN	REF ACC'Y	FACTORY CAL	REF+LIN +CAL	DEVIATION ACC'Y	RESOL
	mV	uV	uV	uV	uV/°C	uV/bit
10V	0/10000	2500	1000	3500	1000	381
1V	0/1000	250	100	350	100.0	38.1
100mV	0/100	25	20	45	10.0	3.81
25mV	0/25	6	20	26	2.5	0.954

	See Note:	1	3	4	5	6
LINEAR RANGES	SPAN	REF. ACC'Y	FACTORY CAL	REF+CAL	DEVIATION ACC'Y	RESOL.
	mA	uA	uA	uA	uA/°C	uA/bit
mA	4/20	5	2	7	2.0	0.763
	0/20	5	2	7	2.0	0.763

NOTES: The Table attempts to show the effect of each significant factor which contributes to the overall measurement error. See the enumerated items below for more specific explanations of each column of data.

1. Reference Acc'y based on 0.025% (250ppm) of input voltage span.
2. Linearization Acc'y is based on conformance to NIST Monograph 175 (based on the ITS-90) for letter-designated thermocouple types, or other industry standards for non letter-designated type T/Cs and all RTDs.
3. Factory Cal is defined by limits of repeatability in a manufacturing environment of  $\pm 10\text{uV}$  for zero and span calibrations on thermocouples, as stated or other inputs, and  $\pm 0.15^\circ\text{C}$  for thermocouple cold junction calibrations.
4. The REF + LIN + CAL column represents the total "static" error allowed for an instrument as produced by the manufacturing process.
5. Deviation Acc'y is derived from a temperature coefficient of  $.01\%/^\circ\text{C}$  or  $\pm 100\text{ppm}/^\circ\text{C}$  expressed in units of the corresponding range.
6. Resolution on thermocouples and RTDs is derived as a function of the input voltage Range and  $dV/dT$ .